

Radio **Electronics**

MAY 1991

TECHNOLOGY - VIDEO - STEREO - COMPUTERS - SERVICE

BUILD THIS DRAM TESTER FOR LESS THAN \$60!

Take the guesswork out of determining whether your dynamic RAM chips are functioning properly and at the rated speed.

BUILD THE PHONE-COM

Use your telephones as a home intercom system.

BUILD A PULSE GENERATOR

Our handheld Pulse-Mate is a handy troubleshooting tool.

SWITCHING REGULATORS

The heart of switching power supplies.

PC-BASED TEST EQUIPMENT

Experimenting with the basic concepts.



\$2.95 U.S.
\$3.75 CAN

A GERNSBACK PUBLICATION

***** CAR-RT SORT ** CR03
750456HRR5165M093 05 05
SEP 91
RE

FLUKE®



PHILIPS

FLUKE 73	FLUKE 75	FLUKE 77
\$79*	\$119*	\$159*
Analog/Digital display	Analog/Digital display	Analog/Digital display
Volts, ohms, 10A (fused), diode test	Volts, ohms, 10A & mA (both fused), diode test	Volts, ohms, 10A & mA (both fused), diode test
0.7% basic dc accuracy	0.5% basic dc accuracy	0.3% basic dc accuracy
2000+ hour battery life	Audible continuity	Touch Hold®
3-year warranty	Autorange/range hold	Audible continuity
	2000+ hour battery life	Autorange/range hold
	3-year warranty	2000+ hour battery life
		Multipurpose holster
		3-year warranty

*Suggested U.S. list price



Simply the Best.

More than two million users agree: the Fluke 70 Series handheld digital multimeters are simply the best.

These originals have become classics. And the reasons are simple.

They are accurate and easy to use. Features made popular by the 70 Series—like fast autoranging, continuity beeper, and quick diode test—are now standards in the industry.

Other 70 Series features stand alone. Touch Hold®, for example, locks the reading on the display and signals you with a beep. So

you can keep your eyes on the circuit and probes.

The 70 Series are built without compromise. All current ranges are fully fused. The resistance function is overload protected to 500V. No detail has been overlooked in making these rugged and reliable meters the first choice of two million professionals.

Made in the USA using state-of-the-art manufacturing methods, every Fluke 70 Series multimeter is backed by a 3-year warranty. Another first in the industry.

Choosing the best handheld multimeter is very simple. Pick up the Fluke 70 Series at your Fluke distributor today. Or call **1-800-44-FLUKE, ext 33**, for a free brochure.

John Fluke Mfg. Co., Inc. P.O. Box 9090, Everett, WA 98206. U.S.: (206) 356-5400. Canada: (416) 890-7600. Other countries: (206) 356-5500. © 1990 John Fluke Mfg. Co., Inc. All rights reserved. Ad. no. 0701-F70

FROM THE WORLD LEADER
IN DIGITAL MULTIMETERS.

FLUKE®

BUILD THIS

- 33 DRAM TESTER**
Build an under-\$60 DRAM unit that performs dynamic-RAM function, speed, and margin tests.
Fred Hufft
- 41 PULSE-MATE**
Our inexpensive single-shot and continuous-pulse generator offers positive and negative pulses.
David Plant
- 44 USE YOUR TELEPHONES AS A HOME INTERCOM SYSTEM**
It's easy to do with our controller board and alert modules!
Frank Polimene
- 56 EXPERIMENTING WITH PC-BASED TEST EQUIPMENT**
Build your own low-cost PC-based test equipment.
James J. Barbarello

TECHNOLOGY

- 49 INSIDE SWITCHING POWER SUPPLIES**
Learn some applications of, and basic troubleshooting techniques for, two switching regulator IC families.
Harry L. Trietely
- 61 PERSONAL COMMUNICATION NETWORK**
Can PCN microcell technology make affordable mobile communications a reality?
Roger P. Newell

DEPARTMENTS

- | | |
|--|--|
| <ul style="list-style-type: none">6 VIDEO NEWS
What's new in this fast-changing field.
David Lachenbruch65 HARDWARE HACKER
More on toner-cartridge reloading and Santa Claus machines!
Don Lancaster72 AUDIO UPDATE
Audio Amplifiers: Do they sound different?
Larry Klein | <ul style="list-style-type: none">75 DRAWING BOARD
A simple, inexpensive logic probe.
Robert Grossblatt77 COMPUTER CONNECTIONS
Video standards.
Jeff Holtzman |
|--|--|

David Plant

When you need a single-shot or continuous-pulse generator, you can buy one or you can build one. The latter is usually the better choice because you can tailor the generator to your needs. This article describes a simple, inexpensive generator that can produce both positive and negative pulses. It's easy to build and can be used in a variety of applications.

It's a good idea to use a single-shot or continuous-pulse generator in a variety of applications. For example, you can use it to generate test pulses for a logic analyzer or to generate pulses for a microcontroller. The generator described in this article is simple to build and can be used in a variety of applications.

PULSE-MATE

This single-shot and continuous-pulse generator is inexpensive and easy to build, yet it offers automatic level setting and both positive and negative pulses.

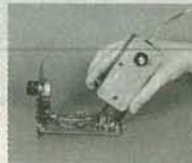

PAGE 41



It's quick and easy to add an intercom feature to your existing home telephone. Frank Polimene

USE YOUR TELEPHONES AS A HOME INTERCOM SYSTEM

It's quick and easy to add an intercom feature to your existing home telephone. This article describes a simple, inexpensive system that can be used in a variety of applications. It's easy to build and can be used in a variety of applications.

PAGE 44

AND MORE

- 96 Advertising and Sales Offices**
- 96 Advertising Index**
- 12 Ask R-E**
- 14 Letters**
- 84 Market Center**
- 28 New Lit**
- 22 New Products**
- 4 What's News**
- 50A RE-Shopper***

*Included in selected issues only.

ON THE COVER



If you've ever had to expand your PC's RAM capacity, troubleshoot a memory problem, or upgrade the cycle speed of a memory bank, you've had the need for a dynamic RAM (DRAM) tester like the one featured on page 33. Our DRAM tester provides an easy method of function testing and measuring the speed (access time) of DRAM IC's. You could spend anything from \$150 to \$1000 to buy a DRAM tester. Or you could build our multifunction unit—which can function test, accurately test speed, and automatically cycle the tests under high-, low-, or normal-voltage margins—for less than \$60!

COMING NEXT MONTH

THE JUNE ISSUE GOES ON SALE MAY 7.

BUILD A 50-MHZ LOGIC ANALYZER

Portable unit with its own LCD, can also be interfaced to your PC.

BUILD AN ELECTRONIC COMPASS

A Hall-effect sensor shows you the way.

VOLTAGE-TO-FREQUENCY CONVERTERS

How to use them in your designs.

PC-BASED TEST EQUIPMENT

More experiments teach the basics of PC-based test equipment.

As a service to readers, RADIO-ELECTRONICS publishes available plans or information relating to newsworthy products, techniques and scientific and technological developments. Because of possible variances in the quality and condition of materials and workmanship used by readers, RADIO-ELECTRONICS disclaims any responsibility for the safe and proper functioning of reader-built projects based upon or from plans or information published in this magazine.

Since some of the equipment and circuitry described in RADIO-ELECTRONICS may relate to or be covered by U.S. patents, RADIO-ELECTRONICS disclaims any liability for the infringement of such patents by the making, using, or selling of any such equipment or circuitry, and suggests that anyone interested in such projects consult a patent attorney.

RADIO-ELECTRONICS, (ISSN 0033-7862) May 1991. Published monthly by Gernsback Publications, Inc., 500-B Bi-County Boulevard, Farmingdale, NY 11735 Second-Class Postage paid at Farmingdale, NY and additional mailing offices. Second-Class mail registration No. 9242, authorized at Toronto, Canada. One-year subscription rate U.S.A. and possessions \$17.97, Canada \$25.65 (includes G.S.T. Canadian Goods and Services Tax Registration No. R125166280), all other countries \$26.97. All subscription orders payable in U.S.A. funds only, via international postal money order or check drawn on a U.S.A. bank. Single copies \$2.95. © 1991 by Gernsback Publications, Inc. All rights reserved. Printed in U.S.A.

POSTMASTER: Please send address changes to RADIO-ELECTRONICS, Subscription Dept., Box 55115, Boulder, CO 80321-5115.

A stamped self-addressed envelope must accompany all submitted manuscripts and/or artwork or photographs if their return is desired should they be rejected. We disclaim any responsibility for the loss or damage of manuscripts and/or artwork or photographs while in our possession or otherwise.

Radio Electronics

Hugo Gernsback (1884-1967) founder

Larry Steckler, EHF, CET,
editor-in-chief and publisher

EDITORIAL DEPARTMENT

Brian C. Fenton, editor
Marc Spiwak, associate editor
Kim Dunleavy,
assistant technical editor
Teri Scaduto, assistant editor
Jeffrey K. Holtzman
computer editor
Robert Grossblatt, circuits editor
Larry Klein, audio editor
David Lachenbruch
contributing editor
Don Lancaster
contributing editor
Richard D. Fitch
contributing editor
Kathy Terenzi, editorial assistant

ART DEPARTMENT

Andre Duzant, art director
Injae Lee, illustrator
Russell C. Truelson, illustrator

PRODUCTION DEPARTMENT

Ruby M. Yee, production director
Janice Box,
editorial production
Karen S. Brown
advertising production
Marcella Amoroso
production assistant

CIRCULATION DEPARTMENT

Jacqueline P. Cheeseboro
circulation director
Wendy Alanko
circulation analyst
Theresa Lombardo
circulation assistant
Michele Torrillo, reprint bookstore

Typography by Mates Graphics
Cover photo by Diversified Photo
Services

Radio-Electronics is indexed in
Applied Science & Technology Index
and *Readers Guide to Periodical Literature*.

Microfilm & Microfiche editions are
available. Contact circulation department
for details.

Advertising Sales Offices listed
on page 98.

Radio-Electronics Executive and
Administrative Offices
1-516-293-3000.

Subscriber Customer Service:
1-800-288-0652.

Order Entry for New Subscribers:
1-800-999-7139.

The
Audit
Bureau
of Circulation



A Shocking Offer!

Now for the first time in CIE's 56 year history you do not have to be enrolled at CIE to receive our introductory Electronic and Electricity Lesson Modules. Available for a limited time to non-students for the shockingly low price of only **\$149.50**

With CIE's patented AUTO-PROGRAMMED method of learning you'll quickly learn and then master the basics of electronics and electricity and then move on to... DC/AC circuit theories, fundamentals of bi-polar junction transistors (BJT), field effect transistors (FET), wiring, diagram and schematic readings, component identification, soldering techniques... and much, much, more.

Your commitment to CIE ends with your payment, but CIE's commitment to your success just begins when you receive your

39 lessons, exams, binders and equipment. This special introductory price includes all the benefits and assistance CIE normally extends to its students and graduates. You'll be entitled to unlimited access to CIE's faculty and staff to assist you in your studies via a toll free 800 number six days a week, 24-hour turnaround on grading your submitted exams. CIE Bookstore privileges, a patented learning method, reference library, a student, faculty and alumni electronic bulletin board and a free issue of CIE's school newspaper The Electron. All this knowledge and support will put you on the road to understanding digital electronics, microprocessing principles, computer systems, telecommunications, and much, much, more.



**All This and Much More
For ONLY!**

\$149⁵⁰

- Free Issue of The Electron
- Build your personal burglar alarm
- Instructors available 6 days a week
- 20 lesson books containing 39 theory and hands-on training lessons and exams.

- Bookstore Privileges
- Patented Learning Method
- Electronic Bulletin Board
- 24-Hour Grading

Yes, send me CIE's 39 Introductory Electronic and Electricity Lessons and Equipment.

Name: _____

Address: _____

City: _____ Apt. #: _____

State: _____ Zip: _____

Age: _____ Phone (_____) _____

Total Merchandise: **\$149.50**

Ohio Residents add 7% Sales Tax: _____

California Residents add 6-1/2% Sales Tax: _____

Total this order: _____

Method of Payment: Amount Enclosed ... \$ _____

Personal Check or Money Order

Master Card Visa

□ □ □ □ □ □ □ □ □ □ □ □ □ □ □ □

Card Expiration Date: _____

Signature _____



BOOKSTORE

1776 East 17th Street
Cleveland, Ohio 44114
(216) 781-9400



CHARGE BY PHONE!



9 AM to 4:30 PM Eastern Time; from Ohio 1-800-523-9109
from all other states 1-800-321-2155

BK03

WHAT'S NEWS

A review of the latest happenings in electronics.

All-digital HDTV development

Major changes have occurred in the US development of HDTV over the past few years. Where NTSC-compatible systems were the early favorites, the FCC has indicated that it will select a simulcast 6-MHz HDTV broadcast standard in 1993—and it is unlikely that the FCC will even consider any analog systems.

After 18 months of cooperative effort, Zenith Electronics Corporation (Glenview, IL), AT&T Bell Laboratories, and AT&T Microelectronics unveiled an all-digital high-definition system that is said to solve many of the problems associated with simulcasting. Zenith handled system definition and transmission technology, AT&T Bell Labs designed and implemented a new video-compression system, and AT&T Microelectronics supplied the necessary semiconductor technology.

Interference now renders unusable many standard 6-MHz channels in the VHF and UHF broadcast spectrum, including those that are targeted to carry HDTV simulcasts. Building upon key elements of Zenith's previously proposed, partially digital "Spectrum Compatible" HDTV, the Zenith/AT&T system uses an advanced digital filtering system that prevents high-powered NTSC signals from interfering with HDTV signals, allowing use of those currently taboo channels. The system, which uses a unique digital filter at the HDTV transmitter and a complementary filter in the HDTV receiver, is said to offer interference- and noise-free signals.

AT&T's research in digital video compression, channel equalization (ghost canceling), and advanced high-speed processors rounded out the system. A critical element is a video-compression algorithm that is used to squeeze the enormous amount of HDTV data into a 6-MHz channel without loss of resolution. The compression technique involves motion compensation, analysis of each frame to prepare it for transmission, and modification of the signal to

compensate for the properties of human vision and the idiosyncrasies of the 6-MHz channels. The HDTV system required high-speed digital signal processors (DSP's), developed by AT&T Microelectronics, to perform the filtering, data encoding, and formatting functions.

The result of all that cooperation is an HDTV system that transmits 1575 horizontal picture lines 30 times a second (compared to 1125 or 1050 lines from competing systems). It uses progressive scan with square pixels, making it easier to interface with computer workstations and to eliminate the jagged edges and other artifacts. Zenith says the system provides "movie-theater-quality pictures and four-channel compact-disc quality digital audio."

We'll learn if their system has what it takes when testing of the five systems remaining in the HDTV race (from an original field of more than twenty) begins this fall by the Advanced Television Testing Center, Cable Television Laboratories Inc., and the Canadian Communications Research Center. After testing is completed, the FCC's Advisory Committee on Advanced Television Services is expected to recommend one as the standard in 1992. The FCC is expected to consider their recommen-

dation and select a standard in the second quarter of 1993.

National hearing-safety campaign

The Electronics Industries Association (EIA), along with electronic-equipment manufacturers and retailers nationwide, launched a year-long public-service program at the 1991 Winter Consumer Electronics Show to help Americans protect their hearing through the safe use of consumer electronics. Experts estimate that 28 million Americans suffer significant hearing problems, and that 10 million of those suffer hearing loss due to excess noise. The EIA's "We Want You Listening For a Lifetime" campaign provides tips on safe equipment use and general information on potential hearing damage caused by playing sound systems at unsafe decibel levels.

High-speed quantum FET

A new device, developed by Valid Logic Systems (San Jose, CA) engineer Gene Cavanaugh, is expected to surpass the 0.2- μm technology that has been considered the practical limit for conventional semiconductor technology. Called the quantum FET, or QFET, the device potentially increases logic speed ten times, and simultaneously reduces power requirements and size by approximately a factor of ten. Cavanaugh has applied for a patent and has approached Texas Instruments, IBM, and Intel concerning possible licensing agreements to provide an opening for actual QFET production.

The single-junction QFET's take advantage of "quantum tunneling," a physical phenomena that increases speed by eliminating the area of electronic conduction in which carriers slow down by up to 3000 times. A manufacturing process called rapid thermal processing, or RTP, based on ultra-fine layers of material, is used. The device has potential applications in developing design-automation tools that benefit from high speed, low power, and small size. **R-E**



**We
Want You
LISTENING
For A Lifetime**

THE EIA'S HEARING-SAFETY CAMPAIGN, launched in January at the Winter Consumer Electronics Show, aims to educate consumers about the dangers of too-high decibel levels.

SELECT 5 BOOKS

for only \$4.95

(values to \$117.75)

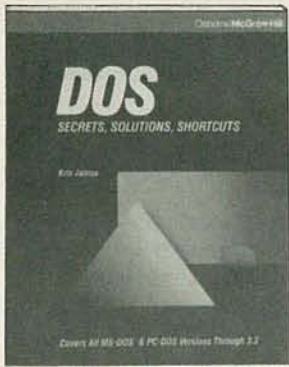

15008P \$24.95



3330P \$19.95



3382P \$29.95



3279 \$36.95
Counts as 2



3111P \$17.95



3616P \$17.95



3441P \$24.95
Counts as 2

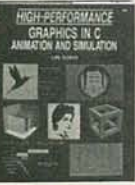

2879P \$22.95



3368P \$19.95
Counts as 2



3213P \$17.95



2959 \$29.95
Counts as 2



3332P \$24.95



3211P \$24.95
Counts as 2



15002P \$22.95



9335P \$19.95
Counts as 2

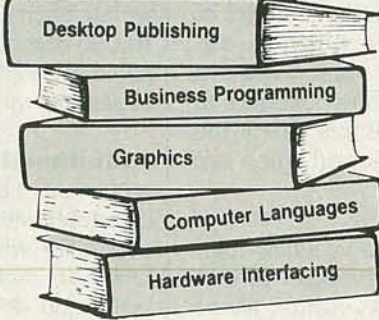

3440P \$17.95



3720 \$26.95
Counts as 2



3617P \$29.95
Counts as 2



3331P \$14.95



3318P \$19.95
Counts as 2



9309P \$28.95
Counts as 2



3204P \$21.95



3563P \$22.95



3176P \$16.95

When it's new and important in business or personal computing, The Computer Book Club has the information you need . . . at savings of up to 50% off publishers' prices!



3006P \$29.95
Counts as 2



3578P \$16.95



3401P \$17.95



3564P \$19.95



3131 \$26.95
Counts as 2

Membership Benefits • Big Savings. In addition to this introductory offer, you keep saving substantially with members' prices of up to 50% off the publishers' prices. • **Bonus Books.** Starting immediately, you will be eligible for our Bonus Book Plan, with savings of up to 80% off publishers' prices. • **Club News Bulletins.** 15 times per year you will receive the Book Club News, describing all the current selections—mains, alternates, extras—plus bonus offers and special sales, with scores of titles to choose from. • **Automatic Order.** If you want the Main Selection, do nothing and it will be sent to you automatically. If you prefer another selection, or no book at all, simply indicate your choice on the reply form provided. You will have at least 10 days to decide. As a member, you agree to purchase at least 3 books within the next 2 years and may resign at any time thereafter. • **Ironclad No-Risk Guarantee.** If not satisfied with your books, return them within 10 days without obligation! • **Exceptional Quality.** All books are quality publishers' editions especially selected by our Editorial Board.

©1991 THE COMPUTER BOOK CLUB Blue Ridge Summit, PA 17294-0820
All books are hardcover unless number is followed by a "P" for paperback. (Publishers' Prices Shown)

The Computer Book ClubSM
Blue Ridge Summit, PA 17294-0820

Please accept my membership in The Computer Book Club and send the 5 volumes listed below, billing me \$4.95. If not satisfied, I may return the books within ten days without obligation and have my membership cancelled. I agree to purchase at least 3 books at regular Club prices during the next 2 years and may resign any time thereafter. A shipping/handling charge and sales tax will be added to all orders.

--	--	--	--	--

Name _____
Address _____
City _____
State _____ Zip _____ Phone _____
Signature _____
Valid for new members only. Foreign applicants will receive special ordering instructions. Canada must remit in U.S. currency. This order subject to acceptance by The Computer Book Club. RPI/C591



3101P \$19.95



30049P \$15.95



3656P \$17.95



3418P \$26.95
Counts as 2



3283 \$28.95
Counts as 2



3415P \$21.95

VIDEO NEWS

What's new in the fast-changing video industry.

DAVID LACHENBRUCH

• **Low-cost captions.** In a hurry-up effort to implement the recent Congressional mandate to include closed-caption decoders in all TV sets 13 inches and larger (**Radio-Electronics**, October 1990), a special Electronics Industries Association (EIA) task force recommended new parameters that would make decoders inexpensive by building upon the on-screen character-generation systems already used in many sets. The EIA plan, which would decipher existing closed captions for the hearing impaired, formed the basis for an FCC rule-making proposal. Members of the task force said the proposed system might add \$2 or \$3 to the cost of a TV set.

The EIA plan envisions certain compromises, making some currently mandatory aspects of caption decoding optional. Those include a special full-screen "text" mode that isn't widely used at present, a second data channel, and captions in color. In exchange, the EIA proposes that Field 2 of Line 21 of the vertical blanking interval be opened up for a better—but optional—second channel, and that the captions be capable of location anywhere on the screen to avoid interference with material in the picture.

The proposal was approved by all members of the EIA task force except the National Captioning Institute, which said its own system, currently in use, could also come down to the \$2-\$3 level when chips are available in large quantities from a variety of sources. The EIA plan possibly can be combined with another EIA project being explored by receiver- and cable-engineering interests. That is a standardized "program identification system," which would make possible on-screen labeling of station call letters and program titles, along with such information as the running time of the program and how much more remains to be shown, at the push of a remote-control button. Ultimately, such information could be combined with automatically recording VCR's, to tape programs of specific interest—for ex-

ample, all non-scheduled news bulletins, or all operas.

The FCC was ordered by Congress to promulgate final closed-captioning rules by April 12. New TV sets made or imported on July 1, 1993 or later must include caption decoders—but some manufacturers are expected to add the decoders to their sets some time this year if the simplified EIA-proposed rules are adopted.

• **Digital HDTV.** As in audio, "digital" has become the magic word in high-definition TV systems. Most contenders for consideration as the American system now have shifted to digital systems, although detailed engineering plans still are scanty. Major digital systems now include those under development by the ACTV Consortium, consisting of Thomson, Philips, NBC, and the Sarnoff Research Center; the Zenith-AT&T combine; and General Instrument.

In the latest development, the MIT team, which had proposed an analog system, is working with General Instrument on a combined digital technology. There are some dissenting voices in the digital race, however. Dr. William Schreiber, formerly of MIT and a longtime TV authority who in the past has questioned the consumer benefits of HDTV, has decried the "stampede" to digital systems at a time when digital transmission hasn't been proven practical. He warned that if all American proposals are digital and digital transmission proves impractical, the 20-year-old Japanese system could be the winner in the U.S. by default.

• **Interactive video.** The FCC has started a rule-making procedure to set aside frequencies for "interactive video data service" (IVDS), which could be used for pay-per-view systems, home shopping, games, educational programming, and even for programming VCR's. The Commission proposes to allocate 500 kHz in the 218-MHz band to IVDS, and to license two operators in each service

area to share in this service from home to TV station or cable system. One interactive proponent said that such a system could probably operate much like cellular phone networks, each cell site connecting up to 10,000 homes by radio and being capable of handling up to 600,000 messages per minute.

• **Multimedia Computing.** What is claimed to be the first mass-market computer with interactive multimedia capability will be manufactured by Emerson Technologies for Trac, Atlanta, and designed to sell for less than \$2,000. The price breakthrough, according to Emerson, is the result of the availability of the "PC Video" chip developed by Chips & Technologies Inc., San Jose, CA. That single-chip processor permits PC's to accommodate input from VCR's, camcorders, TV sets, laser discs, and other video sources, for display on the monitor and storage in the PC's program. It will even let computer operators watch and listen to on-screen newscasts while involved in otherwise serious labor. The PC Video chip initially is priced at \$55 in volume and is claimed to reduce the cost of adding multimedia to computers by as much as 70%.

• **Instant Video.** You may not want to see a full-length movie in 15 seconds, but Explore Technology, of Phoenix, AZ., thinks that's all the time that's needed to transmit it. Explore is proposing a pay-per-view system, based on its patent for data compression, which permits transmission of programming in short bursts to a receiver which stores the information briefly in memory, and then plays it back with the proper timing. Explore says the saving in transmission costs will make such programs competitive with video rentals. The system is said to be compatible with any transmission medium, and includes a transmitter and receiver that can be connected by fiber, satellite, broadcast, coaxial cable, or even phone lines. **R-E**

Now, Testing 68000/386SX Microprocessors Is A Snap.

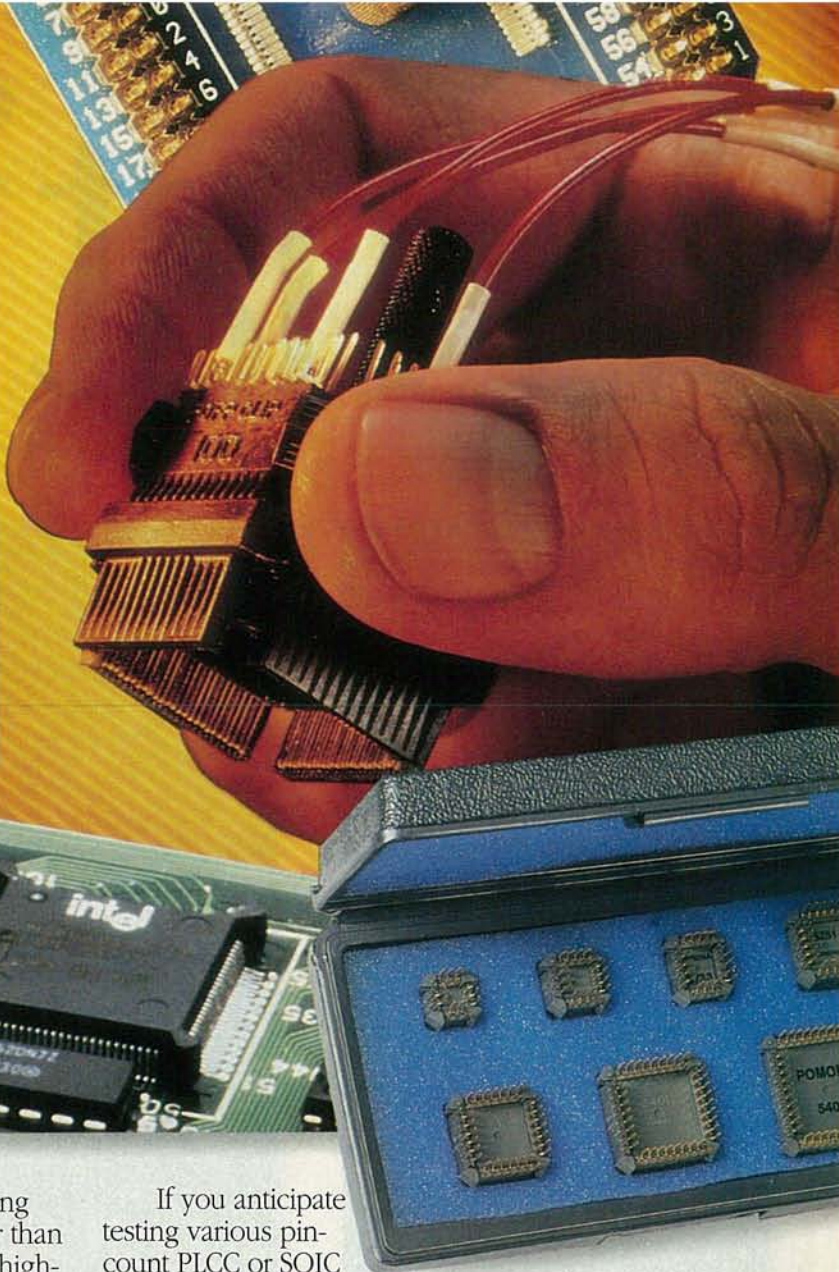

Nothing's faster than the chips being developed today, and nothing's slower than hand wiring or trying to analyze these high-density, surface mounted quad flat pack (QFP) devices for test. No worry, Pomona has the answer.

You can choose Pomona's 5711 SMT Test Clip to grab onto all 132 pins of a Motorola 68020 or 68030, or the 5713, to simultaneously access all 100 pins of an Intel 80386SX. Immediately, your interface with logic analyzers, on-line circuit test systems, or lab instruments will be faster, easier, and reliable. A locking mechanism firmly holds the glass-filled, Nylon insulated clip onto the device, making positive contact with each of the IC's gull-wing leads via specially configured, gold-plated, beryllium copper pins. Above, multi-rows of gold-plated phosphor-bronze pins provide an easy-to-access pattern. Suddenly, interface problems are solved.

If you anticipate testing various pin-count PLCC or SOIC devices, Pomona's Test Clip Kits will make testing faster too. And, to make the interface between your test clip and logic analyzer sockets or emulator pods easier, Pomona's Flying Leads are available in low-cost packs, or supplied with the 5711 and 5713 Test Clips as kits. Of course, all of Pomona's other SMT test accessories are ready to make your IC testing faster and less expensive.

See your Authorized Pomona Distributor or contact POMONA ELECTRONICS, 1500 E. Ninth St., P.O. Box 2767, Pomona, CA 91769. (714) 623-3463. FAX (714) 629-3317.

5515A PLCC Clip Kit
contains seven Pomona Quad® Clip
Adapters from 20-84 pins.

Color-coded Flying Leads simplify interconnections between PLCC or SOIC test clip and logic analyzer sockets or emulator pods; 3 inches long, with female socket one end to .79 dia. pin, 25 leads per pack.



FREE 1991 POMONA CATALOG! 140-pages of newest products and thousands of test solutions.

Nylon is a registered trademark of DuPont

CIRCLE 101 ON FREE INFORMATION CARD

ITT Pomona
AN ITT EMC WORLDWIDE COMPANY
Discover our strengths.

What's you

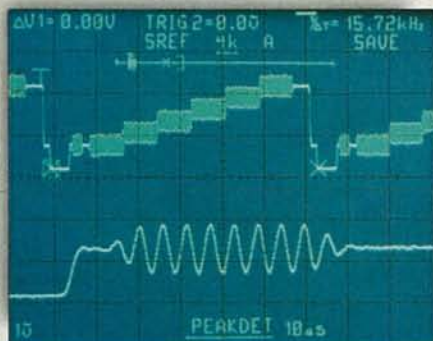

Analyzing TV and complex video signals?

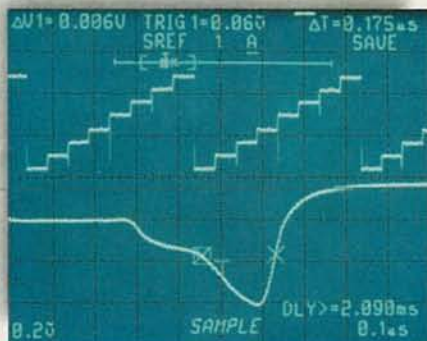

Uncovering elusive glitches?

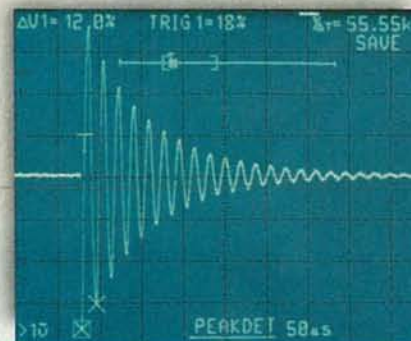

Capturing single-shot events?

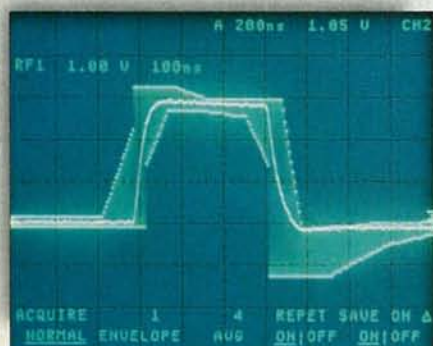

Testing telecommunications signals?



Finding aberrations buried within a signal?

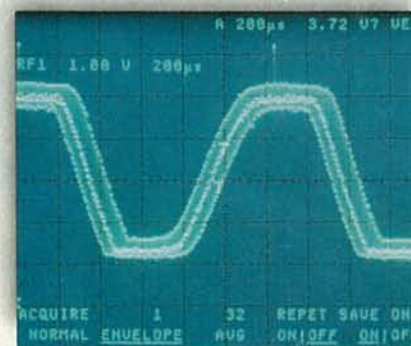

Automatic PASS/FAIL testing?

You can't depend on banner specs alone to solve problems like these.

Whether you're trying to measure waveform parameters or analyze long data streams, identify infrequent events or track down glitches as narrow as 2 ns — there's all the difference between the depth of Tek troubleshooting and the trade-offs in other DSOs that compromise your results.

Spec for spec, feature for feature, no other company offers the credentials Tek does to

effectively match DSO performance to your application needs. Whatever your criteria, you'll find a perfect solution in our line of problem-solving portable DSOs, from 10 to 500 MS/s.

Select the features to support your application. Tek DSOs offer a diverse set of capabilities including peak detect to uncover elusive glitches. Fast update rate for live signal display. Combined analog/digital operation for real-time verification of your

problem?

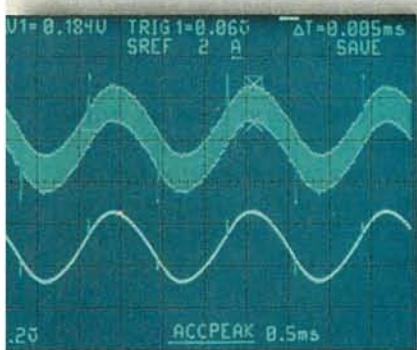

Characterizing signal noise?

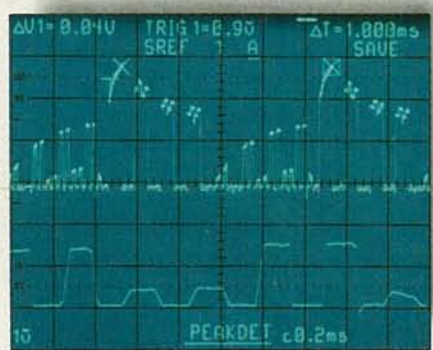

Capturing and analyzing long data streams?

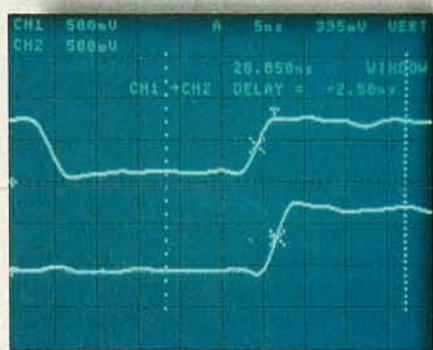

Measuring timing relationship between signals?

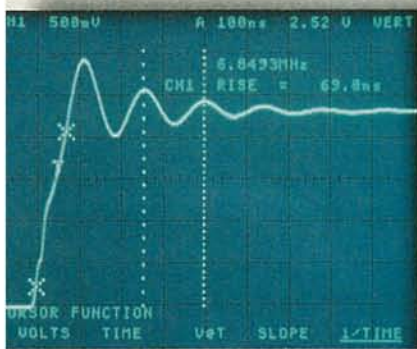

Forming complex measurements automatically?

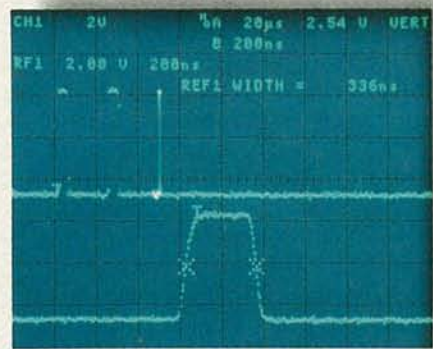

Expanding glitches for close analysis?

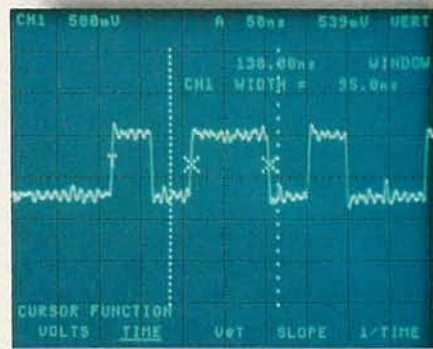

Windowing in on signal details?

signal. Or Save on Delta to automatically verify that all parts of your signal fall within prescribed limits. Best of all, Tek's line of 100 MS/s digitizing scopes start at just \$3995.

To find out which Tek scope is right for you, contact our Tek representative, return the card or call Tek direct. We can answer your questions and show you a scope that doesn't just look good on paper. It makes your toughest troubleshooting challenges routine.

1-800-426-2200



One company measures up.



Tektronix
COMMITTED TO EXCELLENCE

CIRCLE 92 ON FREE INFORMATION CARD

ASK R-E

Write to Ask R-E, Radio-Electronics, 500-B Bi-County Blvd., Farmingdale, NY 11735

PRINT-SCREEN INDICATOR

I'd like to modify my IBM-style keyboard so it has an indicator to show when I'm using the print-screen function. Ideally it should be something similar to the CAPS LOCK, NUM LOCK, and SCROLL LOCK LED's that I currently have. Any ideas?—T. Waller, Yorktown Heights, NY

What you're asking is one of those things that seem simple but is actually quite complex. It's a kind of "Why is the sky blue?" type question.

The first thing to understand is that the PC's keyboard is different from the ones used by Apples and a few of the other popular home computers. The first difference is that it's not a simple matrix keyboard in which each keypress connects two or more wires together to generate a series of highs and lows on a multi-pin connector. The PC keyboard is a serial device, and the standard five-pin connector carries the data, power, clock, ground, and reset signals on separate lines.

The second difference becomes evident once you know of the first difference, since you can't generate serial data without a bunch of silicon. As a result, the PC keyboard is really a small computer in itself and, although different keyboard manufacturers use different IC's, most of them base the keyboard circuitry around a microprocessor specifically designed to handle and control I/O. The 803X, 804X, and 805X micro-

processor series from Intel is a fairly common choice. Figure 1 shows the inside of such a keyboard.

Knowing those facts, you can see that what you want to do has to involve a lot more than piggybacking an LED onto a couple of switches.

That isn't to say that what you want to do is impossible. It's an involved project and would more than likely require you to design some circuitry of your own. Keep in mind that, if you build something that sits inside your keyboard and monitors anything other than the output, you'll more than likely be able to use the device only on your own particular keyboard. Different keyboards use different circuitry. There's not enough room here to go into the details of building a circuit like this but I can block out the approach that I would follow.

There are two basic approaches to the problem. The first is to monitor the data going from the keyboard to the computer and the other is to capture the particular combination of switch closures in the keyboard before they reach the keyboard's controller. I'm not going to take a guess as to which would be easier but, if I was doing this, I'd choose the first alternative since I wouldn't want to take any chance of damaging the keyboard circuitry.

If you do want to modify the keyboard itself, you could try to identify the combination of highs and lows sent on the keyboard's internal data bus whenever you do a Print Screen. Once you've found those, you could

buffer and decode them to drive an indicator such as an LED.

CABLE TRACER

I'd like to trace the path of an underground power cable. One end is above ground and the other end is lost somewhere below ground. Neither end is connected to power. Isn't there some sort of wave generator I could build that would provide a signal I could trace with a receiver and antenna?—D. Andrew, British Columbia, CA

It's really terrific when a simple question like this has a really simple answer. I've faced this problem myself and I'll pass along the method I used.

Most of the commercial equipment that's designed for this purpose works exactly as you described. A signal is sent along the wire and a specially tuned receiver picks it up. Depending on the amount of bells and whistles, that sort of gear can set you back an impressive number of bucks. But there's an alternative.

As long as you're sure that both ends of the cable aren't connected to anything, connect the above-ground end to the 120VAC line (through a fuse and ground-fault protector). Once you've done that, connect the noisiest appliance you have to the line and turn it on. The best ones to use are those with motors that have a set of old brushes in them. You can usually spot that by seeing whether lots of sparks are created where the brushes ride on the motor.

Each one of the sparks is generating a lot of RF noise that's being transmitted down the cable. You can detect the noise with a portable radio since the noise spreads across a wide band of the spectrum. All you have to do is tune the radio between stations (you may find the AM band is better), turn up the volume, and follow the static across the ground. This may seem a primitive method but it's exactly the method used by the "high priced spread."



FIG. 1—A PC KEYBOARD is a small computer in itself. This keyboard's circuitry is based on an 8048 microcontroller that's specifically designed to handle and control I/O.

KEYBOARD UPGRADE

How can I make a 101-key keyboard from an IBM AT operate with an IBM-compatible WYSE PC+ model WY-1400-20? I would be willing to build some simple circuitry if it's necessary.—B. Van de Ayr, Chehalis, WA

While there's probably no reason why you can't do what you want, there are a few problems in getting it done. I'm not familiar with either the Wyse-PC+ or its keyboard but, just because the computers are compatible, there's no guarantee that the keyboards are compatible. (There are different degrees of compatibility.) Not all models of IBM keyboards are interchangeable with each other. The keyboards designed for the XT, for example, will not work with the AT.

If you're dead set on modifying or adapting the Wyse keyboard for use with your AT-compatible computer, you'll need some very specific information before you can get started.

- You need a list of the scan codes produced by the Wyse keyboard and those required by the AT-compatible.
- You need a schematic of the Wyse

keyboard that shows, among other things, the pinouts of the output connector and how the data is transmitted to the computer.

- Although not strictly necessary, make sure the scan codes for the extended function keys (F11 and F12) are compatible with the IBM.

- Be certain that both the power and reset requirements of the Wyse keyboard can be supplied by the IBM.

There's one other thing to be aware of since you're trying to use the keyboard with an AT, rather than an XT. In AT-class computers, the data from the keyboard is handled by a pre-programmed microcontroller in the computer itself. There are a few companies (Phoenix, AMI, etc.) that can supply that, but they are not all compatible with each other. That is usually a consideration only for setting the CMOS configuration memory of the computer, but keep in mind.

Adapting the Wyse keyboard may turn out to be something as trivial as changing the connector on the end of the cable but, considering the fact that you can buy a keyboard for about fifty bucks, you have to wonder it's really worth the effort. **R-E**

It's no fluke.



Made in the U.S.A.

Building the best DMM for the money is no accident. The new RMS225 was carefully designed to give you what you wanted at a price you could afford. Visit your local distributor today and you'll agree the choice is obvious.

Fluke Model 77	Beckman Industrial RMS225
3-1/2 Digits	4 Digits
3,200 Counts	10,000 Counts
0.3% Accuracy	0.25% Accuracy
Touch Hold®	Probe Hold™
31 Segment Analog Bar Graph	41 Segment Analog Bar Graph
2,000 Hour Battery Life	1,000 Hour Battery Life
10A Range (Fused)	10A Range (Fused)
Protective Holster	Protective Holster
3 Yr. Warranty	3 Yr. Warranty
	True RMS
	Auto Min Max™
	Relative Mode
\$159*	\$149

® Touch Hold is a registered trademark of the John Fluke Mfg. Co., Inc. *1990 Fluke and Philips Catalog

Beckman Industrial™
An Affiliate of Emerson Electric Co.

Instrumentation Products Division
3885 Ruffin Road, San Diego, CA 92123-1898
(619) 495-3200 • FAX (619) 268-0172 • TLX 249031
Outside California 1-800-854-2708 Within California 1-800-227-9781
© 1990 Beckman Industrial Corporation. Specifications subject to change without notice. Fluke is a registered trademark of John Fluke Mfg. Co., Inc.

JN190-01-0591

CIRCLE 98 ON FREE INFORMATION CARD

Try the
Radio Electronics®

bulletin board
system

(RE-BBS)
516-293-2283

The more you use it the more
useful it becomes.

We support 300 and 1200 baud
operation.

Parameters: 8N1 (8 data bits, no
parity, 1 stop bit) or 7E1 (7 data
bits, even parity, 1 stop bit).

Add yourself to our user files to
increase your access.

Communicate with other R-E
readers.

Leave your comments on R-E with
the SYSOP.

RE-BBS
516-293-2283

Be an FCC LICENSED ELECTRONIC TECHNICIAN!



Learn at home in spare time.
No previous experience needed!

No costly school. No commuting to class. The Original Home-Study course prepares you for the "FCC Commercial Radiotelephone License." This valuable license is your professional "ticket" to thousands of exciting jobs in Communications, Radio-TV, Microwave, Maritime, Radar, Avionics and more...even start your own business! You don't need a college degree to qualify, but you do need an FCC License.

No Need to Quit Your Job or Go To School
This proven course is easy, fast and low cost! **GUARANTEED PASS**—You get your FCC License or money refunded. **Send for FREE facts now. MAIL COUPON TODAY!**

COMMAND PRODUCTIONS

FCC LICENSE TRAINING, Dept. 90
P.O. Box 2824, San Francisco, CA 94126
Please rush FREE details immediately!

NAME _____
ADDRESS _____
CITY _____ STATE _____ ZIP _____

FREE CATALOG

Call (800) 992-9943

Over 35,000
Electronic Components

Call Today for Your
FREE SUBSCRIPTION

If You Order Today,
WE SHIP TODAY!!



**MOUSER
ELECTRONICS**

(800) 992-9943

Stocking Locations Across America.

CIRCLE 117 ON FREE INFORMATION CARD

LETTERS

Write to Letters, Radio-Electronics,
500-B Bi-County Blvd., Farmingdale, NY 11735

MAC PLUS FIX

I would like to thank **Radio-Electronics** for the fine article on building a Mac clone (January 1991). My Mac Plus nuked itself last week. I removed the power board and, upon taking the board to two Apple dealers, I was told that it would cost \$300 to fix—and I would have to put the board back in the Mac and then bring them the whole machine. No way! I opened the magazine and called Pre-Owned Electronics. They sent me the board in two days for \$119. I want to thank you guys for all the help in locating decent merchants who want to do honest business. Keep up the good work.

RICHARD RUSSO

TABLE THAT TABLE!

I read the article "1 Volt = ?" (**Radio-Electronics**, February 1991) with considerable interest. It was well

written and comprehensive. It contained a gratifying amount of basic physics and pulled together a great many ideas that are often hard to find because they are scattered over several different chapters in various textbooks.

Were it not for one fundamental flaw, Table 1 would be an extremely useful reference for students of several academic disciplines. The author used an obsolete and (now) non-standard set of base (or principal) quantities.

Intellectually and philosophically I like the author's choice of charge as a base unit and his derivation of dimensional equivalents in terms of coulombs. I also still "like" to use mhos, micro-microfarads, milli-microamps, and kilo-megacycles. Nevertheless, those outdated standards are all contrary to the American National Standards that have been in effect for some time now and really are the ones that should be used.

If the author and your editors would check the IEEE Dictionary for "units and letter symbols," I believe they will find that the electric base quantity (in the SI system) is *current*, not charge. Charge is now properly described as a "derived" quantity that has dimensions of (current \times time) or ampere-seconds. Regrettably, that means that in each of the author's "Dimensional Equivalents" in Table 1, the Coulomb (C) term should be replaced with (A \times s), and the terms re-collected.

I know this all seems perverse to old-timers who learned to start with the charge on the electron and to calculate how many electrons it takes to make a coulomb, but there is a good practical reason for the change. When you use current as the base unit for electrical measurement, you can define the ampere in terms of the force exerted upon two parallel conductors. That is evidently something that is more directly measurable in terms of mass, length, and time—and more up-to-date.

LUCIUS DAY
Lakewood, CO

Matsushita

Picture Perfect!

Make your video servicing problems disappear without a trace with the latest service bulletin reference from the company that knows video servicing best. Matsushita.

Fifth in a series of service bulletin compilations, the SB-09 features ninety-five pages of valuable troubleshooting information for popular Panasonic and Quasar consumer cameras, camcorders and video cassette recorders manufactured between 1983 and 1990.

To order your SB-09, send a check or money order for \$23.95 (or \$25.35 if ordering from NJ) to the address below. These amounts include shipping and handling charges, and tax where applicable. Please include a copy of this ad with your order. Allow 4-8 weeks for delivery. Sorry, but we cannot accept COD's, purchase orders, credit cards, account charges, or orders from outside the USA.

Realize your potential with servicing aids by Matsushita!

**Matsushita
Services Company**

Technical Administrative Department
50 Meadowland Parkway 2B 61MO
Secaucus, NJ 07094

The Technician's Edge



**SB-09
Panasonic/Quasar
Service Bulletin Reference**
\$19.95
PLUS SHIPPING
AND HANDLING

REMOVING IC'S

Thank you for the years of excellent reading in the extremely diverse field of electronics. I've been reading **Radio-Electronics** on and off for some years, and have enjoyed every issue.

Now for the good news. Over the years I have read letters from readers about the handling of IC's and the questions concerning their abuse. Well, here is some shocking news. When chips (TLL's, CMOS, etc.) are manufactured, they are dipped in a molten material. Notice I said molten, which means that the material is in liquid state. The material used and the temperature of that material must give off heat during the change of state from liquid to solid. Thinking about that concept, I began to work on a way to extract circuit-board components without the use of desoldering tools, and one that would save plenty of time.

Try this out for size: Using a *hot* oil bath as a desoldering fluid and keeping the temperature down to a level that the IC's could handle, I dropped the board in, and within seconds parts began to fall off the board. The temperature of the oil bath should be no lower than 370°F and no hotter than 380°F. That temperature is within an IC's tolerance.

The only exception is electrolytic capacitors, as they will explode and send hot oil all over the place.

Use gloves and eye protection during this process. I have extracted hundreds of useful parts that way and have had an 80% success rate. I said 80% because some plastics cannot withstand that temperature, and the hot oil can break down some plastics altogether.

I hope your readers can use this information—but if you do, be sure to observe safety first. And thanks again for the excellent reading material. Keep up the good work.

MICHAEL BROWN
Stockton, CA

Your method sounds a little dangerous to us, but it does show that where there's a will, there's a way!—Editor.

AM PROBLEMS

Since **Radio-Electronics** printed the article "Whatever Happened to AM Radio" (September 1990), I thought the editors and readers might be interested in the reply I

received from my congressman in reply to my suggestion that AM stereo circuitry be mandatory in future AM/FM stereo equipment. Congressman Dale E. Kildee said, in part, "In recent years, new technologies have been employed that have led to a wider use of AM stereo components. At this time, no legislation has been introduced in the House of Representatives that would require stereo manufacturers to place AM stereo components in their equipment."

All three AM-only radio stations in my area were sold at bargain prices last year—one at auction, one in bankruptcy court, and one to a church. Only the latter, a gospel station, emerged with no major changes. The first, which was a leading Top-40 station in the 60's and 70's, became a Christian station whose last Arbitron rating was 0.0. The second, formerly the leading news and information station, switched to a satellite-fed, heavy-metal rock format called "Z-Rock." Despite adding AM stereo equipment, the station was not successful, and went off the air. The owner (who also owns a mobile-home sales lot and added another one on the radio-station grounds) plans to try another format, but as of this writing the station is still off the air.

It would appear that your article is right on the mark concerning AM radio's problems.

GARY FLINN
Flint, MI

WRIST STRAPS

Steve Swenton's statement on using a wrist strap when desoldering static-sensitive devices (*Letters, Radio-Electronics*, September 1990), "...always use a ground strap (a metal wrist strap with a detachable ground wire) and connect its wire to ground..." needs further clarification, lest someone fashion a homemade wrist grounding strap from that description.

Commercially available wrist strap/ground wires contain a current-limiting resistor, usually 1 megohm, in order to protect the operator. One should never connect oneself to a hard ground when working around sources of potentially lethal (e.g., household) current.

JOHN L. HORNBY
Madison, CT

Earn Your B.S. Degree in ELECTRONICS or COMPUTERS



By Studying at Home

Grantham College of Engineering, now in our 41st year, is highly experienced in "distance education"—teaching by correspondence—through printed materials, computer materials, fax, and phone.

No commuting to class. Study at your own pace, while continuing on your present job. Learn from easy-to-understand but complete and thorough lesson materials, with additional help from our instructors.

Our Computer B.S. Degree Program includes courses in the BASIC, PASCAL, and C languages — as well as Assembly Language, MS DOS, CADD, and more.

Our Electronics B.S. Degree Program includes courses in Solid-State Circuit Analysis and Design, Control Systems, Robotics, Analog/Digital Communications, and more.

An important part of being prepared to *move up* is holding the right college degree, and the absolutely necessary part is knowing your field. Grantham can help you both ways—to learn more and to earn your degree in the process.

Write or phone for our free catalog. Toll free, 1-800-955-2527, or see mailing address below.

Accredited by
the Accrediting Commission of the
National Home Study Council

GRANTHAM
College of Engineering
Grantham College Road
Slidell, LA 70460

MAY 1991

XT-TO-AT UPGRADE

Having worked for a company that manufactures floppy disks, I'd like to make several comments concerning the differences between various disk formats.

It's true that 5¼-inch, high-density (1.2 MB) drives have twice as many tracks as the regular 360K drives. That doesn't increase the chance of crosstalk, however, because the track width (the width of the track written or read by the head) is, of course, also half as great.

It isn't a case of the write current being decreased on high-density (HD) drives. Instead, the write *field* is increased. That is necessary because there is a fundamental difference between disks designed for HD operation and non-HD operation: The HD disks' coating material needs a *higher* field to reliably saturate (i.e., be fully magnetized one way or the other).

The software on an AT can change the write current on an HD drive. There's a pin specifically for that on the drive interface, and the BIOS can flip it when required. Indeed, it *has* to reduce the write current when writing

to 360K disks because otherwise the excessive write field would cause each transition, as it was being written, to affect the previously written transition.

The recorded level may seem low when reading on a 360K drive a disk written on a 1.2-MB drive, but that is because only one-half the normal track width has been written, causing a reduced signal output of approximately 70%. I have never had any problems from that, since drives are rated to work with dropouts to 45% remaining signal and below. However, it is true that the loss of signal level does reduce your operating margin against problems like misalignment and drift. Of course, HD drives are rated to work with 360K-formatted disks despite the reduction in available signal level.

Where problems most often arise is when disks are overwritten by a succession of different drives. Remember that HD drives can write only half-width tracks (relative to a 360K drive). So if a track is written "wide" and overwritten "narrow," a "wide-reading" drive will read both the new, wanted, narrow track and the rem-

nant of the old wide track together.

Remember that the directory area of the disk is rewritten whenever you add a file! The above problem may render every one of the files on the disk inaccessible from the addition of a single file, because the entire directory has been corrupted.

For the sake of completeness, I should mention that, while 3½-inch HD disks have a different material from regular (720K) 3½-inch disks, there is no difference in track widths, ruling out the problem of overwriting. Also, the coating materials are similar enough that a 720K diskette can often be formatted for 1.44 MB without any errors reported during the format. However, the non-HD disks are highly marginal with the HD format, and you are highly likely to encounter reliability problems. Recent 1.44-MB systems have implemented a sensor that detects the HD hole to prevent non-HD disks from being incorrectly formatted. It is probably also undesirable to format 3½-inch HD disks as 720K, but I haven't checked into that.

DANNY WILLIS
Munich, Germany

ATTENTION! ELECTRONICS TECHNICIANS

EARN YOUR
**B.S.E.E.
DEGREE**

THROUGH HOME STUDY

Our New and Highly Effective Advanced-Placement Program for experienced Electronic Technicians grants credit for previous Schooling and Professional Experience, and can greatly reduce the time required to complete Program and reach graduation. No residence schooling required for qualified Electronic Technicians. Through this Special Program you can pull all of the loose ends of your electronics background together and earn your B.S.E.E. Degree. Upgrade your status and pay to the Engineering Level. Advance Rapidly! Many finish in 12 months or less. Students and graduates in all 50 States and throughout the World. Established Over 40 Years! Write for free Descriptive Literature.

COOK'S INSTITUTE
OF ELECTRONICS ENGINEERING



4251 CYPRESS DRIVE
JACKSON, MISSISSIPPI 39212

JAN CRYSTALS

*your reliable source for
a world of crystal clear
communication*



- Commercial Two-Way
- MicroProcessors
- Amateur/Experimental
- Scanners/Monitors/Pagers
- Satellite-Telemetry
- Plus custom applications

EXPEDITED ORDER SERVICE!

FOR FREE CATALOG,
CALL OR WRITE:

JAN CRYSTALS

P.O. Box 06017
Ft. Myers, FL 33906
(813) 936-2397



TOLL FREE 1-800-526-9825
FAX ORDERS: 1-813-936-3750

CIRCLE 104 ON FREE INFORMATION CARD

SUPER LONG PLAY TAPE RECORDERS

12 Hour Model —
USES 120 TAPE
\$119.00*

Modified Panasonic Slimline,
high quality AC-DC provide 6
continuous hours of quality
recording & playback on each
side of cassette for 12 hours
total. Includes • Voice level
control • Digital counter,
etc. TDK - 120 Cassette
Furnished.



PHONE RECORDING ADAPTER
Records calls automatically. All Solid
state connects to your telephone
jack and tape recorder. Starts
recording when phone is lifted.
Stops when you hang up.



VOX VOICE ACTIVATED CONTROL SWITCH
Solid state. Self contained. Adjust-
able sensitivity. Voices or other
sounds automatically activate and
control recorder. Uses either re-
corder or remote mike. \$28.50*



* Add for ship. & handling. Phone Adapter & Vox \$2.00 each
Recorders \$5.00 each. Calif. Res. add tax. Mail order, VISA,
M/C, COD's OK. Money Back Guarantee. Quantity discounts
available. Dealer Inquiries invited. Free data.
AMC SALES INC. Dept. 29335 Lubec Street
Box 928, Downey, CA 90241
Phones (213) 869-8519 1-800-926-2488
FAX (213) 923-1478
Mon-Fri 8-5 PAC. TIME

CIRCLE 108 ON FREE INFORMATION CARD

HOW MUCH SHOULD YOU PAY FOR 10 INSTRUMENTS, 39 FUNCTIONS AND 4000 COUNT ACCURACY? Just \$139.95 if you say PROTOMETER™!



- 1 DC VOLTMETER**
- 2 AC VOLTMETER**
- 3 OHMMETER**
- 4 20A AMPMETER**
- 5 DIODE/LED TESTER**
- 6 TRANSISTOR TESTER**
- 7 CAPACITANCE TESTER**
- 8 FREQUENCY COUNTER**
- 9 LOGIC PROBE**
- 10 CONTINUITY TESTER**

PROTOMETER™ 4000 is the Professional Multi-Function Portable Instrument System. Ten test instruments in a 3-3/4 Digit, 4000 count handheld package. Packing the power of our complete instrument line. Combining a digital multimeter, frequency counter, transistor/capacitance tester, and more into a durable no-nonsense

drop-resistant case. Plus standard features like a large LCD display, peak hold, and a unique high-voltage warning indicator. Looks like the competition's DMM and priced like one too!

But PROTOMETER™ 4000 is much more than a DMM. Compare for yourself. Clearly the best value in portable instruments. Why pay just as much for a DMM, when you can get ten test instruments for one low price. How much should you pay? Just \$139.95, if you say PROTO METER™ 4000.

Order Yours Today!! **\$139.95**



Call Toll-Free For Details
1-800-572-1028

**GLOBAL
SPECIALTIES®**

Global Specialties®
70 Fulton Terrace, New Haven, CT 06512
Telephone: (203) 624-3103. ©Interplex Electronics, 1991.

A028

CIRCLE 192 ON FREE INFORMATION CARD

MAY 1991

No other training—anywhere—shows you service computers

Only NRI walks you through the step-by-step assembly of a powerful AT-compatible computer system you keep—giving you the hands-on experience you need to work with, troubleshoot, and service all of today's most widely used computer systems. With NRI at-home training, you get everything you need to start a money-making career, even a computer service business of your own.

No doubt about it. The best way to learn to service computers is to actually *build* a state-of-the-art computer from the keyboard on up. And that's just what you do when you train with NRI. As you perform key tests and demonstrations at each stage of assembly, you see for yourself how each part of your computer works, what can go wrong, and how you can fix it.

Only NRI, the leader in career-building electronics training for more than 75 years, gives you such practical, real-world computer servicing experience. Indeed, no other training—in school, on the job, *anywhere*—shows you how to troubleshoot and service computers like NRI.

You get in-demand computer skills as you train with a powerful AT-compatible computer system—now with 1 meg RAM and 20 meg hard drive

With NRI's exclusive hands-on training, you actually build and keep the powerful new AT-compatible West Coast 1010ES computer, complete with 1 meg RAM and 20 meg hard disk drive.

You start by assembling and testing the "intelligent" keyboard,

Now includes AT-compatible, 20 meg hard drive, and exciting new diagnostic package!

move on to test the circuitry on the main logic board, install the power supply and 5-1/4" high-density floppy drive, then interface your high-resolution monitor. But that's not all.

Your NRI hands-on training continues as you install a powerful 20 megabyte hard disk drive—today's most-wanted computer peripheral—included in your course to dramatically increase your computer's data storage capacity while giving you lightning-quick data access.

HARD DISK DRIVE

The 20 megabyte hard disk drive you install internally gives you greater data storage capacity and access speed.

AT-COMPATIBLE COMPUTER

80286 CPU (12 MHz clock, 0 wait states), 1 meg RAM (expandable to 4 meg), 1.2 meg high-density floppy disk drive.

DIGITAL MULTIMETER

Professional test instrument for quick and easy circuit measurements.

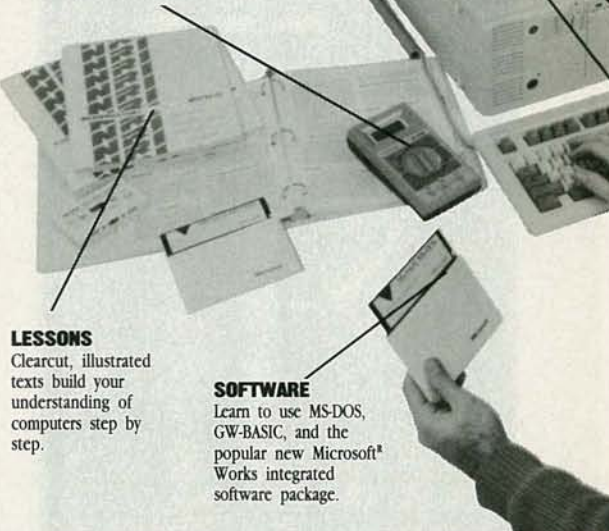

LESSONS

Clearcut, illustrated texts build your understanding of computers step by step.

SOFTWARE

Learn to use MS-DOS, GW-BASIC, and the popular new Microsoft® Works integrated software package.

NEW!

New! Training now includes Ultra-X diagnostic hardware and software for quick, accurate troubleshooting!



Now NRI takes your hands-on computer servicing experience an important step further: Now you train with and keep the remarkable R.A.C.E.R. plug-in diagnostic card and QuickTech diagnostic software from Ultra-X—professional diagnostic tools that make computer troubleshooting fast and accurate.

Using these state-of-the-art tools, you learn to quickly identify and service virtually any computer

in school, on the job, how to troubleshoot and like NRI

MONITOR

High-resolution, nonglare, 12" TTL monochrome monitor with tilt and swivel base.

TECHNICAL MANUALS

You get "inside" your AT-compatible computer system with exclusive NRI Training Kit Manuals plus technical specs direct from the manufacturer.

DISCOVERY LAB

Complete breadboarding system to let you design and modify circuits, diagnose and repair faults.

DIGITAL LOGIC PROBE

Using your logic probe, you get firsthand experience analyzing digital circuit operation.

No experience needed... NRI builds it in

You need no previous experience in computers or electronics to succeed with NRI. You start with the basics, following easy-to-read instructions and diagrams, moving step by step from the fundamentals of electronics to sophisticated computer servicing techniques.

With NRI's unique Discovery Learning Method, you're sure to get the kind of practical, hands-on experience that will make you fully prepared to take advantage of every opportunity in today's top-growth computer service field.

You learn at your own convenience, in your own home. No classroom pressures, no night school, no need to quit your present job until you're ready to make your move. And all throughout your training you've got the full support of your personal NRI instructor and the entire NRI technical staff, always ready to answer your questions and help you achieve your training goals.

Your FREE NRI catalog tells more

Send today for your free, full-color catalog describing every aspect of NRI's innovative computer training, as well as hands-on training in video/audio servicing, telecommunications, industrial electronics, and other growing, high-tech career fields.

If the coupon is missing, write to NRI School of Electronics, McGraw-Hill Continuing Education Center, 4401 Connecticut Avenue, NW, Washington, DC 20008.

AT is a registered trademark of International Business Machines Corporation. R.A.C.E.R. and QuickTech are registered trademarks of Ultra-X, Inc.

problem on XT, AT 80286/80386, and compatible machines. You discover how to use the R.A.C.E.R. card to identify individual defective RAM chips, locate interfacing problems, and pinpoint defective support chips. Plus you learn to use your QuickTech diagnostic software to test the system RAM and such peripheral adapters as parallel printer ports, serial communications ports, video display memory, and floppy and hard disk drives.

Only NRI gives you such confidence-building, real-world experience. Only NRI gives you both the knowledge and the professional tools to succeed as today's in-demand computer service technician.

SEND TODAY FOR FREE CATALOG

NRI Schools

McGraw-Hill Continuing Education Center
4401 Connecticut Avenue, NW, Washington, DC 20008



For career courses approved under GI Bill, check for details.

CHECK ONE FREE CATALOG ONLY

- Microcomputer Servicing
- TV/Video/Audio Servicing
- Telecommunications
- Industrial Electronics & Robotics
- Security Electronics
- Electronic Music Technology
- Basic Electronics

- Computer Programming
- PC Systems Analysis
- PC Software Engineering Using C
- Desktop Publishing & Design
- Word Processing Home Business
- Paralegal
- Fiction/Nonfiction Writing
- Automotive Servicing

- Building Construction
- Air Conditioning, Heating, & Refrigeration
- Electrician
- Small Engine Repair
- Locksmithing
- Bookkeeping & Accounting

Name _____ (please print) Age _____

Address _____

City/State/Zip _____ Accredited Member, National Home Study Council 3-051

NEW PRODUCTS

Use the Free Information Card for more details on these products.

CATV-RF SIGNAL ANALYZER.

The *FS74A Channelizer Sr.* from Sencore includes an exclusive, all-channel, microprocessor-controlled tuner for testing all standard and cable channels to FCC accuracy, including the return channels, sub-band, off-air VHF, UHF, and FM. By selecting FCC, HRC, or ICC carrier shift tuning, the user can simply dial in the channel and read the video or audio signal level displayed in microvolts or dBmV on the fully-autoranging meter. The *FS74A* also allows the user to analyze the audio/video ratio on any channel without calculations, by setting the function control to the A/V position and reading the ratio in dB.

Sencore's patented on-channel automatic signal-to-noise ratio test eliminates time-consuming signal comparisons and calculations that are usually required when referencing noise on an unused chan-



CIRCLE 16 ON FREE INFORMATION CARD

nel. Another patented feature, the automatic dB-hum-level test, measures hum on any modulated channel, and measures AC and DC volts through the RF input jack. The built-in digital voltmeter also can be used to measure AC and DC voltage, as well as ohms. The unit's built-in wideband (4-MHz) video monitor shows picture-quality and sync-compres-

sion problems. For portable use, the signal analyzer can be powered by two field-rechargeable batteries. A carrying case, strand hook, and IEEE 488 and RS-232 interfaces are available as options.

The *FS74A Channelizer Sr.* TV-RF signal analyzer costs \$3495.—**Sencore, Inc.**, 3200 Sencore Drive, Sioux Falls, SD 57107; Phone: 1-800-SENCORE.

LOGIC ANALYZER.

Designed for applications in circuit design, digital testing, ATE development, education, microprocessor design and debugging, and logic analysis, *Rapid Systems' R3800* logic analyzer features 16K data buffers for each of 32 input channels, allowing users to capture long, high-speed digital signals at a 100-MHz sample rate. Powerful PC-based software simplifies setup and measuring, and provides selectable sample rates to 100 MHz. The *R3800* also offers complex triggering with a sequence

of four 32-bit data patterns, trigger delay of up to 64K clocks, four trigger levels with data qualifiers, and a zoom-display function. It can load, save, and print

displays and files and can list in Hex, Bin, ASCII, or Dec.

The *R3800* 32-channel logic analyzer costs \$3995.—**Rapid Systems, Inc.**, 433 North 34th Street, Seattle, WA 98103; Phone: 206-547-8311; Fax: 206-548-0322.



CIRCLE 17 ON FREE INFORMATION CARD

PORTABLE VIDEO FRAME GRABBER.

With a low-power design that allows it to operate for up to ten years on a single 9-volt lithium battery, *Portable Technologies' PFG-1* provides a portable, conve-

nient, and affordable way to do gray-scale image capture from live video sources. The unit is continuously powered and ready for frame-grabbing at any time. The resultant image has a resolution of 320x320 pixels with 64 levels of gray. Square pixels are obtained with standard NTSC or RS-170 video signals from video cameras, camcorders, VCR's, or TV monitors.

The *PFG-1* can digitize and store a video frame independently in 1/60 of a second. The captured image is stored in internal memory until overwritten by another frame grab. The stored image can be transferred to any computer equipped with a standard RS-232 interface. There are no add-on cards to install. Frame

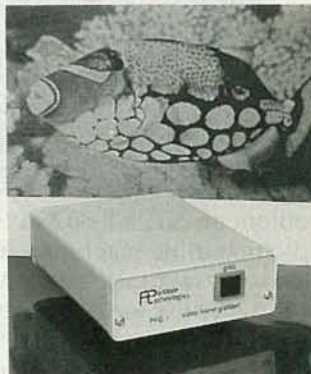

CIRCLE 18 ON FREE INFORMATION CARD

grabbing can also be initiated under computer control via the serial interface.

The frame grabber comes with PGRAB software, which runs on IBM-PC and compatible computers with CGA, EGA, or VGA and at least 128K of RAM. The software allows



THE MODEL WTT-20 IS ONLY THE SIZE OF A DIME, yet transmits both sides of a telephone conversation to any FM radio with crystal clarity. Telephone line powered - never needs a battery! Up to 1/4 mile range. Adjustable from 70-130 MHZ. Complete kit **\$29.95 + \$1.50 S + H**. Free Shipping on 2 or more! COD add \$4. Call or send VISA, MC, MO. **DECO INDUSTRIES, Box 607, Bedford Hills, NY 10507. (914) 232-3878.**

CIRCLE 127 ON FREE INFORMATION CARD



COMPUTER KITS, BOARDS & COMPONENT PARTS. Designed to the highest degree of *quality* and *reliability* available today. They're fun, easy to build, educational, IBM compatible, very *powerful*, and at great prices. All items are pre-tested, include a full year warranty, step by step assembly manual, and free tech support. Assembly available at no extra charge. For free catalog contact: **GENERAL TECHNICS, P.O. BOX 2676, LAKE RONKONKOMA, NY 11779, or call (516) 981-9473.** VISA, MasterCard, American Express, COD.

CIRCLE 176 ON FREE INFORMATION CARD



FREE CATALOG! ELECTRONIC TOOLS & TEST EQUIPMENT. Jensen's new Master Catalog, available free, presents major brand name electronics tools, tool kits, and test instruments, plus unique, hard-to-find products for assembly and repair and custom field service kits available only from Jensen. All fully described and illustrated. Enjoy free technical support and rapid, post-paid delivery anywhere in the Continental USA. **JENSEN TOOLS INC., 7815 S. 46th St., Phoenix, AZ 85044. Phone: 602-968-6231; FAX: 1-800-366-9662.**

CIRCLE 115 ON FREE INFORMATION CARD

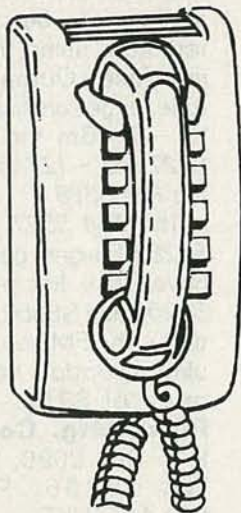

CALL NOW AND RESERVE YOUR SPACE

- 6 x rate \$940.00 per each insertion.
- Fast reader service cycle.
- Short lead time for the placement of ads.
- We typeset and layout the ad at no additional charge.

Call **516-293-3000** to reserve space. Ask for Arline Fishman. Limited number of pages available. Mail materials to: mini-ADS, RADIO-ELECTRONICS, 500-B Bi-County Blvd., Farmingdale, NY 11735.

FAX: 516-293-3315



CABLE TV CONVERTERS AND DE-SCRAMBLERS SB-3 \$79.00 TRI-BI \$95.00 MLD-\$79.00 M35B \$69.00 DRZ-DIC \$149.00. Special combos available. We ship COD. Quantity discounts. Call for pricing on other products. Dealers wanted. **FREE CATALOG.** We stand behind our products where others fail. One year warranty. **ACE PRODUCTS, P.O. Box 582, Saco, ME 04072 1 (800) 234-0726.**

CIRCLE 75 ON FREE INFORMATION CARD



ZF1

ZF2

ZENITH TEST CHIP (ZF1). New improved Data Injector Fully activates Z-tacs **\$29.95** No jumpers to cut. Just solder 4 wires and plug chip into socket. **ZENITH TEST BOARD (ZF2)** Fully activates the 165 chip on the 288 chip's data stream. **\$49.95** Both units for test purposes only, not for signal theft. **PHONE: 800-722-9381**



APPLIANCE REPAIR HANDBOOKS—13 volumes by service experts; easy-to-understand diagrams, illustrations. For major appliances (air conditioners, refrigerators, washers, dryers, microwaves, etc.), elec. housewares, personal-care appliances. Basics of solid state, setting up shop, test instruments. **\$2.65 to \$7.90 each.** Free brochure. **APPLIANCE SERVICE, P.O. Box 789, Lombard, IL 60148. (312) 932-9550.**

CIRCLE 84 ON FREE INFORMATION CARD

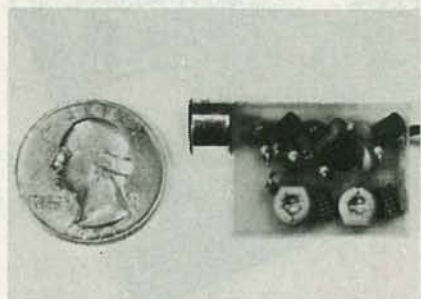

SIMPLY SNAP THE WAT-50 MINIATURE FM TRANSMITTER on top of a 9v battery and hear every sound in an entire house up to 1 mile away! Adjustable from 70-130 MHZ. Use with any FM radio. Complete kit **\$29.95 + \$1.50 S + H**. Free shipping on 2 or more! COD add \$4. Call or send VISA, MC, MO. **DECO INDUSTRIES, Box 607, Bedford Hills, NY 10507. (914) 232-3878.**

CIRCLE 127 ON FREE INFORMATION CARD

Save on cable rental fees!

CABLE TV DESCRAMBLERS WE'LL BEAT ANY PRICE!

CALL TOLL-FREE 1-800
284-8432

JERROLD-TOCOM-ZENITH
HAMLIN-OAK-PIONEER
SCIENTIFIC ATLANTIC

- 24 HOUR SHIPMENTS!
- MONEY BACK GUARANTEE!
- FREE CATALOG & INFO!
- QUANTITY DISCOUNTS!

MASTER CARD / AMEX / VISA / C.O.D.



Have make and model number of
equipment used in your area ready

1-800-284-8432

CABLE WAREHOUSE

4700 N. HIATUS ROAD, SUNRISE, FLA. 33351
NO FLORIDA SALES

CIRCLE 180 ON FREE INFORMATION CARD

Try the

**Radio
Electronics.**

bulletin board
system

(RE-BBS)
516-293-2283

The more you use it the
more useful it becomes.

We support 300 and 1200
baud operation.

Parameters: 8N1 (8 data
bits, no parity, 1 stop bit)
or 7E1 (7 data bits, even
parity, 1 stop bit).

Add yourself to our user
files to increase your
access.

Communicate with other
R-E readers.

Leave your comments on
R-E with the SYSOP.

RE-BBS
516-293-2283

the image to be displayed
on the screen, adjusted for
brightness and contrast,
printed directly to HP
Laserjet II and compatible
printers, and saved either
as linear files or as TIFF
files that can be imported
to most desktop-publishing
applications. The PFG-1
also includes a DB9 serial
cable, a DB9-to-DB25
adaptor, an RCA video cable,
and a 9-volt lithium battery
as well.

The PFG-1 portable video
frame grabber costs \$269.—**Portable Technologies**, P.O. Box
20763, Castro Valley, CA
94546; Phone:
415-537-4954.

RF SIGNAL GENERATORS. With optional FM-
stereo-modulation capability,
the Philips PM 5327 and PM
5328 RF-signal generators from
John Fluke Mfg. Co. are well
suited for use in the test

formation about all signal
parameters and settings,
the multifunction backlit
LCD screen simplifies operation
of the signal generators.
Push-button-activated menus
are used for setting frequency,
output level, modulation mode,
and modulation parameters.
The PM 5328 has a large rotary-
control knob with variable
resolution, for quick selection
of the desired value. Frequencies
and levels can also be set by
step-by-step adjustments or by
direct numeric entry of the
value.

Both models can store and
instantly recall complete front-
panel setups. The PM 5328 has
memory for 99 setups and the
PM 5327 can store 10. Stored
settings can be called up
remotely, using the GPIB
interface. Output amplitude
ranges are from -127 to -7
dBm for the PM 5327 and -127
to +13 for the PM 5328.

The PM 5327 and PM 5328
RF-signal generators have base
list prices of \$4900 and \$5650,
respectively. The FM-stereo-
modulation option has a list
price of \$750.—**John Fluke Mfg. Co., Inc.**,
P.O. Box 9090, Everett, WA
98206; Phone:
800-44-FLUKE.



CIRCLE 19 ON FREE
INFORMATION CARD

and repair of consumer audio
electronics. The 180-MHz
instruments can be used either
as stand-alone benchtop tools
or, using the GPIB interface,
in test systems. The PM 5328
also features a built-in 200-
MHz frequency counter. The
signal generators' standard
modulation modes include AM,
FM, and frequency sweep. A
high-stability frequency-reference
option is also available to ensure
accuracy in higher-performance
applications. Modulation can
be external as well as internal,
and parameters such as modulation
frequency, sweep width, and
sweep time are user-selectable.

By providing full, clear in-



CIRCLE 20 ON FREE
INFORMATION CARD



An ETCHED
circuit board
from a
Printed PAGE
in just 3 Hours

The ER-4 PHOTO ETCH KIT gives you the tools, materials and chemicals
to make your own printed circuit boards. The patented Pos-Neg™ process
copies artwork from magazines like this one without damaging the page.
Use the circuit patterns, tapes and drafting film to make your own 1X
artwork. Or try the Direct Etch™ system (also included), to make single
circuit boards without artwork. The ER-4 is stocked by many electronic
parts distributors, or order direct, postpaid.

ER-4 PHOTO ETCH KIT (NJ and CA residents add sales tax) . . . \$38.00

DATAK'S COMPLETE CATALOG lists hundreds of printed circuit products
and art patterns. Also contains dry transfer letter sheets and electronic title
sets for professional looking control panels. **WRITE FOR IT NOW!**

DATAK Corporation • 55 Freepoint Blvd, Unit 23 •
Sparks, NV 89431

CIRCLE 187 ON FREE INFORMATION CARD

counter in one compact case. The *FG-150's* generator section outputs sine, square, triangle, ramp, and skewed sine waveforms. Its frequency is 0.02 Hz to 2 MHz, and impedance is 50 ohms $\pm 10\%$, 600 ohms $\pm 10\%$, up to 100 kHz. The frequency variable range is 100:1 and the symmetry variable range is 10:1 to 1:10. The *FG-150* has linear/logarithmic sweep modes. The internal counter has 1-Hz, 10-Hz, 100-Hz, and 1-kHz resolution; a 4-digit LED with annunciators; 100-ms, 1-second gate times, and accuracy of time base error plus one digit. The external counter's frequency range is 1 to 9999 kHz and its sensitivity is 15 mV RMS.

The *FG-150* sweep/function generator with built-in frequency counter has a suggested list price of \$295. — **BelMerit Corporation**, 14775 Car-

menita Road, Norwalk, CA 90650; Phone: 213-802-3666; Fax: 213-802-3298.

COMPONENT/HDTV WAVEFORM MONITOR.

Designed to provide convenient, precise video-system measurements for



CIRCLE 21 ON FREE INFORMATION CARD

525/60 and 625/50 component, NTSC and PAL composite, and HDTV (1125/60) signals. *Leader Instruments' model 5100* component/HDTV waveform monitor features four-channel output (three transcoded to RGB from Y, R-Y, and B-Y for 525/60

systems). Also featured are overlaid display of four signals, such as Y, R-Y, B-Y, and composite, as well as parade displays of three channels. A vector display of color difference or RGB signals checks component chrominance, while display of the unique "shark-fin" signal provides a high-resolution relative-timing reading over a wide bandwidth. The model 5100 provides full raster line selection for 525/60, 625/60, and 1125/60 signals. Cursor operation makes it easier to make level measurements and to preset measured parameters to specified values. Powered by either 12 VDC or 90-250 VAC, the instrument is completely portable for field use.

The model 5100 component/HDTV waveform monitor costs \$3800. — **Leader Instruments Corporation**, 380 Oser

Avenue, Hauppauge, NY 11788; Phone: 800-645-5104 (in NY, 516-231-6900).

PEN-TYPE DIGITAL MULTIMETER.

Designed for applications where the technician doesn't have much room to maneuver, *Beckman's DM73* is a pen-style, hand-held digital multimeter that features a 3½-digit display with 0.5% accuracy (DC 2V range) and auto-ranging. Its compact



CIRCLE 22 ON FREE INFORMATION CARD

size, light weight, and simple slide switch for changing functions make the *DM73* easy to use for trou-

PUT THE PC10 IN YOUR PC FOR MORE COUNTER POWER.

OPTOELECTRONICS does it again - phenomenal power, performance and price.

This is what sets our PC Based Universal Counter apart from any other counter available on the market today...

- Instant Direct Tune - Set a communications receiver such as ICOM R7000 to frequency detected by counter. Patent pending.
- Data logging and data file creation to keep records or measure frequency drift.
- Menu selection for Units includes CPM/RPM, Hz, KHz, MHz, GHz, Sec, mS, uS and nS.
- Software timebase calibration of 1ppm TCXO timebase.

- Windows 3.0 operating environment with fully developed operating and signal conditioning controls accessible through pull down menus.

In addition to these unique features, **PC10** is a down right high performance counter...

- 10 digit 10Hz to 2.4GHz frequency range.
- Measurement Period (Gate Time) continuously variable from 1 milli-second to 28 seconds.
- Reciprocal Counting for high resolution measurement.
- Input sensitivity is less than 10mV from 10Hz to over 1.6GHz.
- Direct count frequencies over 200MHz with 1Hz resolution in 1 sec.

Model PC10 Universal Counter Timer Board for the PC.

Introductory Price \$339.
The *PC10* has on board 50 ohm RF input with amplifiers and prescalers to operate as a stand alone 1MHz to 2.4GHz RF counter. TTL level input signals can be connected directly to the miniature 25 pin D connector on the mounting bracket. For low frequency, high impedance inputs, the *Model AP10H* companion amplifier must be used.

Model AP10H Dual High Impedance Amplifier Head Unit (not shown).

Introductory Price \$299.
The *AP10H* is the companion head unit that supports all *PC10* Universal Counter functions from 10Hz to 100MHz with 1 megohm inputs. Input attenuators, low pass filters and trigger levels are software selectable.
Options: TCXO 10 Precision Temperature Compensated Time Base \$195.
 ± 0.2 ppm 20°-40°C, 1ppm - year aging.



OPTOELECTRONICS

Toll Free Order Line: 1-800-327-5912
FL (305) 771-2050 • FAX (305) 771-2052
5821 NE 14th Avenue • Fort Lauderdale, Florida 33334



PC10 direct tunes communication receivers.

CIRCLE 188 ON FREE INFORMATION CARD

Get A Complete Course In

ELECTRONIC ENGINEERING

8 volumes, over 2000 pages, including all necessary math and physics. 29 examinations to help you gauge your personal progress. A truly great learning experience.

Prepare now to take advantage of the growing demand for people able to work at the engineering level.

Ask for our brochure giving complete details of content. Use your free information card number, or write us directly. **\$59.95 to \$119.95**, Postage Included. Satisfaction guaranteed or money refunded.



**Banner
Technical
Books, Inc.**

1203 Grant Ave.
Rockford, IL 61103

CIRCLE 67 ON FREE INFORMATION CARD

Choose From Our Line-Up



Increase your efficiency and productivity with Tech Spray's complete line of chemical products and accessories including:

Blue Shower® cleaner/degreaser—A fast and complete contact cleaner safe on sensitive components. Contains no CFCs.

Precision Duster OFM™ dusting gas—Moisture-free, zero residue, non-flammable and non-abrasive. Contains no CFCs.

minus 96 Instant Chiller freeze spray—Detects cracks in PCBs, helps prevent cold solder joints, protects heat-sensitive components and cools components during mounting. Contains no CFCs.

For more information on these products or any other Tech Spray product, contact:

TechSpray

P.O. Box 949 • Amarillo, TX 79105-9935
800-858-4043 • In TX 800-692-4677
Fax: 806-372-8750

bleshooting and installing host computer. *DSPerato* electronics in tight places contains a full-length IBM-PC prototype card that already has a bus decode and buffer printed circuit. The rest of the card has uncommitted 0.100 center-plated through holes with power buses and pads. The 56001 DSP and support chips are wired and soldered on those pads.

Two optional high-performance video and audio A/D and D/A converter boards can be attached to the card via 0.100 center pin headers. The 16-bit audio board uses Motorola's 56ADC 16-bit converter; Other features of the *DM73* include an audible continuity check, a buzzer that sounds when changing functions, a built-in scabbard for the ground probe, and a display of the function in use. The DMM has full auto-ranging capability on 12 measurement ranges. DC voltages up to 500V, AC voltages to 250V, and resistance up to 2 megohms are measured using an accurate dual-slope integrating analog-to-digital (A/D) conversion technique.

The *DM73* pen-type digital multimeter, complete with batteries, test leads, and operator's manual, has a list price of \$69.95.—**Beckman Industrial Corporation**, Instrumentation Products Division, 3883 Ruffin Road, San Diego, CA 92123-1898; Phone: 619-495-3200.

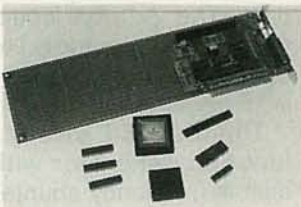

CIRCLE 23 ON FREE INFORMATION CARD

The *DM73* pen-type digital multimeter, complete with batteries, test leads, and operator's manual, has a list price of \$69.95.—**Beckman Industrial Corporation**, Instrumentation Products Division, 3883 Ruffin Road, San Diego, CA 92123-1898; Phone: 619-495-3200.

PC-CARD PROTOTYPING KIT. To provide a broad base of PC-users with low-cost digital-signal-processing (DSP) capabilities, *Signal-Systems'* is offering *DSPerato*, a real-time, DSP expansion-card prototyping kit that features a Motorola 56001 DSP chip. Motorola's 56001 DSP runs at 20 MHz, delivers 10 MIPS, and offers advanced technologies including pipeline instruction fetches; parallel data moves to three separate 24-bit (X-data, Y-data, and program) memories; and easy interfacing to the

8-bit video card uses Sony's 8-bit 20-MHz semi-flash converters. For maximum flexibility in custom projects, the user can opt for both converters, just one, or neither to be attached to the DSP card.

Parts needed to populate the DSP card and the converter kits—including all chips, sockets, resistors, and capacitors as well as the 56001 DSP and 8K × 24-bit 45-ns static RAM—are included. The user can add parts as needed to configure the card for custom applications. All assembly instructions and schematics required for connecting the DSP and the converters are also included, along with Signal-Tools software. Signal-Tools' functions include real-time spectrum analysis, digital oscilloscope, and waveform capture and generation. The software features a keyboard- or mouse-driven pull-down menu interface.

CABLE - TV

SIGNAL REMOVERS

- FOR ELIMINATION OF SEVERE INTERFERENCE
- FOR "CENSORING" OF ADULT BROADCASTS



FOR FULL DESCRIPTION OF USES ask for our free brochure

- ATTENUATION - 45 dB TYPICAL
- BANDWIDTH - 4 MHz AT 5 dB POINTS
- INSERTION LOSS - 2 dB

MODEL	TUNING RANGE	FOR CHANNELS	PASSBAND	PRICE	SHIPPING
23H	50-66 MHz	2,3 (or 6 meter ham)	50-300 MHz	\$30	NO SHIPPING or C.O.D. CHARGES
46FM	66-108 MHz	4,5,6 (or any FM)	50-300 MHz	\$30	
1417	120-144 MHz	14(A) 15(B) 16 (C) 17(D)	50-400 MHz	\$30	
1822	144-174 MHz	18(E) 19(F) 20(G) 21(H) 22 (I)	50-400 MHz	\$30	
713	174-216 MHz	7,8,9,10,11,12,13	50-400 MHz	\$30	

3 for \$75 - 10 for \$200 - mix or match

CALL TOLL FREE FOR C.O.D. OR SEND CHECK TO ORDER
FAST DELIVERY
30 DAY MONEY BACK GUARANTEE (3 FILTER LIMIT)

Star Circuits

P. O. Box 94917
Las Vegas, NV 89193-4917

1-800-433-6319

Optionally available is a software development kit that contains MACRO-DSP, a 56001 DSP macro assembler for IBM-PC's; a debugger, and linkable object modules.

DSPerato costs \$299, the audio and video converter boards cost \$149 each, and the software development kit including MACRO-DSP costs \$99.—**Signal-Systems**, 15105 S.E. East Avenue, Milwaukie, OR 97267.

800-MHz GROUND-PLANE ANTENNA. Because broad-band scanner antennas perform poorly at higher frequencies, many scanner listeners hear only a small fraction of the signals available on the 800-MHz band. The *MAX800* 800-MHz ground-plane antenna from *Cellular Security Group* is a specialized mono-band antenna designed to alleviate that

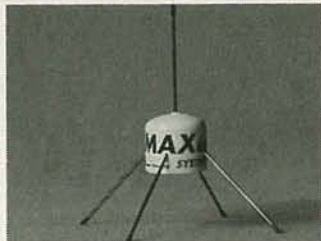

CIRCLE 24 ON FREE INFORMATION CARD

problem. Based on plans presented in the ARRL Handbook, the element lengths are cut precisely to the proportionate dimensions. The design supports the elements, protects the feed-point, and provides a quick and easy mounting. EMThe *MAX800* 800-MHz ground-plane antenna costs \$19.95; optional type-N connector models of long 38-inch PVC mounting masts are available for an additional \$5.00.—*Cellular Security Group*, 4 Gerring Road, Gloucester, MA 01930; Phone: 508-281-8892. **R-E**

Try the

Radio Electronics

bulletin board system

(RE-BBS)
516-293-2283

The more you use it the more useful it becomes.

We support 300 and 1200 baud operation.

Parameters: 8N1 (8 data bits, no parity, 1 stop bit) or 7E1 (7 data bits, even parity, 1 stop bit).

Add yourself to our user files to increase your access.

Communicate with other R-E readers.

Leave your comments on R-E with the SYSOP.

RE-BBS
516-293-2283

LEARN VCR
CLEANING/MAINTENANCE/REPAIR
EARN UP TO \$1000 A WEEK, WORKING PART TIME FROM YOUR OWN HOME!



Secrets Revealed!

NO Special Tools or Equipment Needed.

EARN UP TO \$60 AN HOUR AND MORE!

THE MONEY MAKING OPPORTUNITY OF THE 1990'S

IF you are able to work with common small hand tools, and are familiar with basic electronics (i.e. able to use voltmeter, understand DC electronics). . . .

IF you possess average mechanical ability, and have a VCR on which to practice and learn. . . . then we can teach YOU VCR maintenance and repair!

FACT: up to 90% of ALL VCR malfunctions are due to simple MECHANICAL or ELECTRO-MECHANICAL breakdowns!

FACT: over 77 million VCRs in use today nationwide! Average VCR needs service or repair every 12 to 18 months!

Viejo's 400 PAGE TRAINING MANUAL (over 500 photos and illustrations) and AWARD-WINNING VIDEO TRAINING TAPE reveals the SECRETS of VCR maintenance and repair—"real world" information that is NOT available elsewhere!

Also includes all the info you'll need regarding the BUSINESS-SIDE of running a successful service operation!

FREE INFORMATION
CALL TOLL-FREE 1-800-537-0589

Or write to: Viejo Publications Inc.
5329 Fountain Ave.
Los Angeles, CA 90029 Dept. RE

CIRCLE 185 ON FREE INFORMATION CARD

FREE CATALOG with over 100 innovations to add comfort and convenience to your home.

Latest in electronics.

Heath Company's new Home Automation catalog features easy-to-install electronics that bring sophisticated technology into your home for as little as \$12.95. Simple. Easy to install. Affordable. Guaranteed.

Some bring you peace of mind.

Affordable protection for your home or car. Expandable security systems to meet your needs today and tomorrow. Advanced motion sensor lighting that reduces false triggering (often caused by blowing leaves or small pets) by up to 75%. You get protection where and when you need it, indoors and out.

Some save you time.

Watch the kids play outside, monitor the baby's room, or see who's at the front door just by looking at your television screen. (Who says you can't be two places at once?) Call home to turn on your slow-cooker or other appliances. From one center, control lights, fans, air conditioners — almost

HOME AUTOMATION BY HEATH

anything that plugs into an electrical outlet.

Some just make life easier.

Add a portable phone extension to any electrical outlet. Automatically lower the volume of your music system whenever the phone rings. Or play a movie on the living room VCR and watch it on your bedroom TV.

100% satisfaction ... the Heath guarantee for over 40 years.

Try any Heath product at no risk. If you aren't completely satisfied, simply return the item within six months for credit or full refund.



Call 1-800-44-HEATH for your FREE CATALOG.

Free call for a free catalog. Or, just mail the coupon below. Heath adds comfort and convenience ... and makes coming home even better.

Heath

Benton Harbor, Michigan

Please send me the NEW Home Automation catalog.

Name _____

Address _____

_____ Apt. _____

City _____

State _____ Zip _____

Mail to Heath Company, Dept. 020-050, Benton Harbor, MI 49022.

HA-101

CIRCLE 86 ON FREE INFORMATION CARD

MAY 1991

27

NEW LIT

Use The Free Information Card for fast response.

HDTV: HIGH-DEFINITION TELEVISION; by Stan Prentiss. Published by Tab Books Inc., Blue Ridge Summit, PA 17294-0850; Phone: 1-800-233-1128; \$16.95.

Already a reality in Japan (albeit with a steep price tag and limited programming), HDTV is eagerly awaited around the rest of

the U.S. The book explains the competing delivery and receiving systems under development, discussing their pros and cons and describing the methods used to create those systems. In addition, the book covers the progress of HDTV variants that could enhance the performance of standard TV receivers, such as improved-definition television and extended-definition television.

HEATHKIT WINTER 1991 CATALOG. From Heath Company, Department 350-054, Benton Harbor, MI 49022; Phone: 1-800-44-HEATH; free.

Bound into this 60-page catalog is a special "Home Automation" insert that devotes 28 pages to a variety of innovative products for safety, security, convenience, entertainment, and energy management in and around the home. Aimed at do-it-yourselfers,



CIRCLE 38 ON FREE INFORMATION CARD

the home-automation products include whole-house automation and security systems, motion-sensing indoor and outdoor lights, wall switches, wireless video broadcasters, wireless phone extensions, flood sensor alarms, an elec-

tronically controlled pet door, and automatic-lawn sprinkling systems. The main catalog includes a variety of easy-to-build electronic kits as well as tools, weather instruments, computers, amateur-radio equipment, home-entertainment products, and home-study electronics courses and videos.

CONSUMER ELECTRONICS SYSTEMS TECHNICIAN SAFETY GUIDELINES. From EIA/CEG, Department PS, 2001 Pennsylvania Avenue, N.W., Washington, DC 2006-1813; \$1.00.

Although manufacturers strive to make their products safe to use and to service, and student technicians are taught the inherent dangers in the work, technicians often tend to become complacent with experience. This brochure is intended to remind them of possible dangers and to keep safety considerations a conscious part of their work. It contains important safety guidelines that should be followed and updated UL requirements for safe installation and servic-



CIRCLE 39 ON FREE INFORMATION CARD

ing of antennas, TV's, and other consumer-electronics products.

U.S. GOVERNMENT BOOKS FOR BUSINESS PROFESSIONALS. From U.S. Government Printing Office, Free Business Books Catalog, Stop SM, Washington, DC 20401; free.

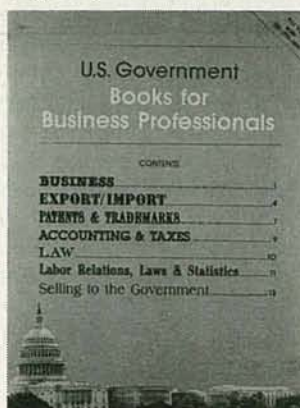

CIRCLE 40 ON FREE INFORMATION CARD

Whether you own your own company, have joined the ranks of those who are supplementing their day jobs by running a second business from their homes, or come up with patentable creations on your workbench, the publications listed in this catalog contain information you'll find valuable. Intended to create greater awareness of and access to government information for the business community, the 22-page catalog contains the most popular government business books and subscriptions that are sold to the public. Those publications cover such fields as accounting and taxation, selling to the government, exporting, labor law, patents and trademarks, and business statistics. **R-E**

the world. More than a dozen major corporations currently are competing to perfect the revolutionary technology that promises to bring crystal-clear pictures and high-quality sound to television. This book is intended to help prepare engineers, technicians, students, and marketing managers for the unveiling of HDTV.

The book provides an inside look at both the technical and the legislative aspects of high-definition television. It explores the widely divergent industry standards in North America, Europe, and Japan that are now impeding HDTV production, and analyzes FCC and congressional regulation of HDTV research and development in

CIE Gives You The Training You Need to Succeed... At Your Own Pace...& In Your Own Home!

Discover Your Career Potential In The
Fast-Growing Field Of High-Tech Electronics!

If you're anxious to get ahead...and build a real career...you owe it to yourself to find out about the Cleveland Institute of Electronics!

CIE can help you discover your career potential in the fast growing field of high-tech electronics. A career that will challenge and excite you every day...reward you with a powerful feeling of personal accomplishment...and deliver a level of financial security you may have only dreamed of before!

As the leading school in home-study electronics, CIE has helped over 150,000 students in the U.S.A. and over 70 foreign countries get started in this exciting field. To find out how CIE could be helping you...read on...then send for a CIE catalog TODAY!

A Growing Need For Trained Professionals!

The career opportunities shown here are only a few of the challenging, high-paying careers you could enjoy as an electronics technician.

You could be the "brains" behind the scenes of an exciting TV broadcast...trouble-shoot life-saving medical equipment...design exotic new aeronautics systems...CIE's job-oriented programs offer you the quickest possible path to the career of your dreams! And CIE also features military and union re-training, to build on what you already know.

Dozens Of Fascinating Careers To Choose From!

Even if you aren't sure which career is best for you, CIE can get you started with core lessons applicable to all areas of electronics. As you advance, CIE makes job opportunities available to you through the bimonthly school paper, *The Electron*.

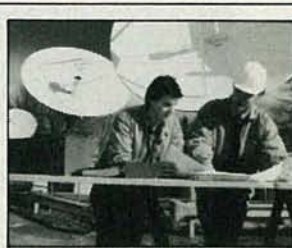

Data Communications



Automotive Electronics



Avionics



Computer-Assisted Manufacturing



Consumer Electronics



Military Electronics

Personal Training From A Renowned Faculty.

Unlike the impersonal approach of large classroom study, CIE offers you one-on-one instructional help 6 days a week, toll-free. Each CIE lesson is authored by an independent specialist, backed by CIE instructors who work directly with you to answer your questions and provide technical assistance when you need it.

Practical Training... At Your Own Pace.

Through CIE, you can train for your new career while you keep your present job. Each course allows a generous completion time, and there are no limitations on how fast you can study. Should you already have some electronics experience, CIE offers several courses which start at the intermediate level.

"State-Of-The-Art" Facilities & Equipment.

In 1969, CIE pioneered the first electronics laboratory course, and in 1984, the first Microprocessor Laboratory. Today, no other home study school can match CIE's state-of-the-art equipment. And all your laboratory equipment is included in your tuition cost. There is no extra charge—it's yours to use while you study at home and on the job after you complete your course!

Earn Your Degree To Become A Professional In Electronics!

Every CIE course you take earns you credit towards the completion of your Associate in Applied Science Degree, so you can work towards your degree in stages. And CIE is the only school that awards you for fast study, which can save you thousands of dollars in obtaining the same electronics education found in four-year Bachelor's Degree programs!

Send For Your Catalog Today!



CIE World Headquarters

Cleveland Institute of Electronics, Inc.
1776 East 17th St., Cleveland, Ohio 44114

YES! Please send me your independent study catalog (For your convenience, CIE will have a representative contact you—there is no obligation.)

Print Name _____

Address _____ Apt # _____

City/State/Zip _____

Age _____ Area Code/Phone No. _____

Check box for G.I. Bill bulletin on educational benefits: Veteran Active Duty

Mail This Coupon Today!

AE10

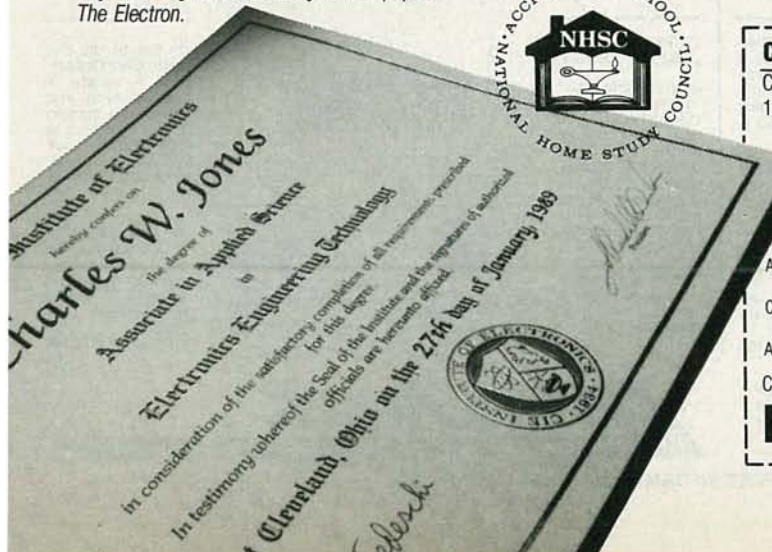

RADIO SHACK PARTS PLACESM

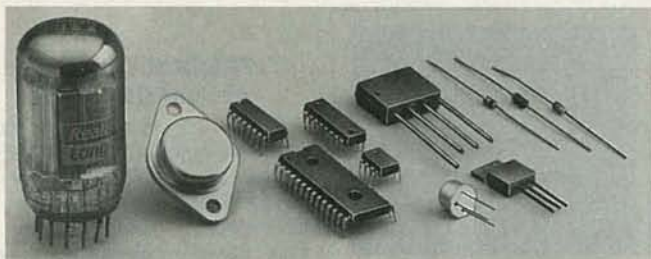

PARTS SPECIAL-ORDER HOTLINE. Your local Radio Shack offers a huge selection of electronic components. Plus, we can special-order over 10,000 items from our warehouse—ICs, tubes, semiconductors, crystals, phono cartridges and styl, even SAMS® manuals. Delivery time for most items is one week. And there are no postage charges or minimum order requirements.



BATTERY SPECIAL-ORDER HOTLINE. In addition to our large in-store stock, Radio Shack can now supply almost any currently manufactured consumer-type battery—quality replacements for cordless telephones, computer memory, camcorders, transceivers, pagers and more. Discover the Radio Shack "hotline" advantage—fast service with no postage or handling charges.

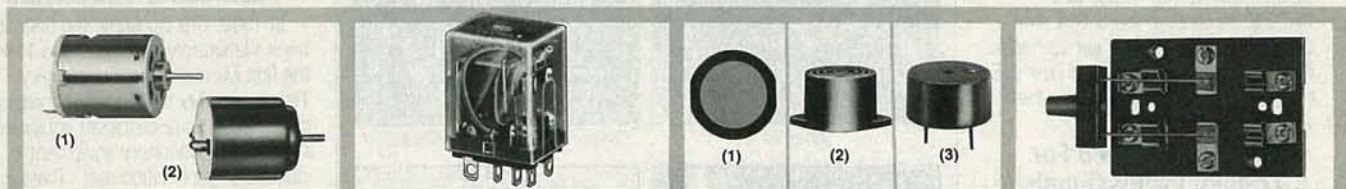

(1) **High-Speed 12VDC Motor.** Up to 15,200 RPM. About 2" long (with shaft). #273-255 2.99
 (2) **Hobby Motor.** For robotics and projects. 1 1/2 to 3VDC. About 1 1/2" long. #273-223 99¢

Heavy-Duty Plug-In DPDT Relays. Contacts rated 10 amps at 125VAC. Size: 1 5/8 x 1 x 3/4".
 12VDC Coil. #275-218 5.99
 125VAC Coil. #275-217 5.99
 Relay Socket. #275-220 1.79

(1) **Mini Piezo Speaker.** Only 1 3/16" diameter. #273-091 . . . 2.49
 (2) **"Ding-Dong" Chime.** Requires 6 to 18VDC. #273-071 . . . 8.99
 (3) **Mini Buzzer.** Loud, yet only 7 mA at 12VDC. #273-074 2.99

DPDT Knife Switch. Just the thing for low-power switching in science projects, model railroads and more. Rated 0.5 amp at 200VDC. Screw terminals. Mounting holes on base. #275-1537 1.29

Lamp Holders. For indicators and projects. Figs. 1 and 2 accept E-10 threaded-base bulbs, available at Radio Shack.

(1) **Round Style.** Screw terminals. #272-357 79¢
 (2) **Compact.** Solder lugs. #272-356 99¢
 (3) **Bayonet Base.** #272-355 6/99¢



LCD DVM With Capacitance and Transistor Gain Ranges. Extra-feature digital multimeter with easy-to-read 0.5" display and 10 megohm input. 30 ranges—measures AC/DC voltage and current, resistance, capacitance and transistor gain. #22-194 79.95

XLR Connectors
 (1) **Inline Socket.** #274-011 2.99
 (2) **Three-Pin Plug.** #274-010 2.99
 (3) **Panel Socket.** #274-013 3.69
 (4) **Adapter Transformer.** Connects XLR-type mike to equipment with 1/4" phone jack input. #274-016 11.99
 (5) **Adapter Transformer.** Connects mike with 1/4" plug to XLR jack input. #274-017 11.99

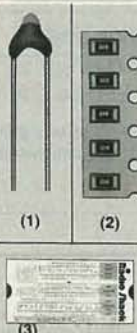
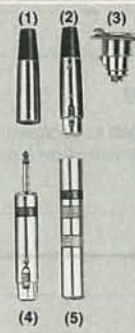

(1) **Precision Thermistor.** Resistance changes in proportion to temperature. Has measurement range from -50 to +110° C. #271-110 1.99
 (2) **Surface-Mount Resistors.** Big 200-piece assortment! Popular values, rated 1/4 watt, 5%. #271-313, Set 4.99
 (3) **Ohm's Law Guide.** Fast answers to Ohm's law and parallel resistance problems. #271-1211 49¢

(1) **Telescoping Antenna.** Extends to 24". (16 styles in stock.) #270-1413, 3.99
 (2) **"N" Battery Holder.** (14 other styles in stock.) #270-405 59¢
 (3) **Mini-Hook Adapters.** Slip on test probe tips. #270-334, Pr./2.59
 (4) **Micro-Hook Test Clips.** #270-355 2.69

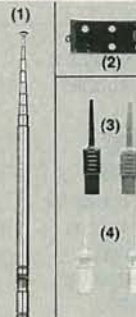

Portable Short-wave Antenna. Dramatically improves reception on worldband portables! Connector clips to telescoping rod antenna. Antenna wire extends up to 23 feet—and winds up on pocket-size reel for convenient storage, travel. #278-1374, 8.95

(1) **Prewired Temperature Module.** Just add one "AA" battery for use as a thermometer. You can also connect simple circuits to control external indicators and devices at temperatures you set. (Data included.) Has 1/2" liquid crystal display and selectable Fahrenheit or Centigrade modes. Module is easily panel-mounted. #277-123 19.95

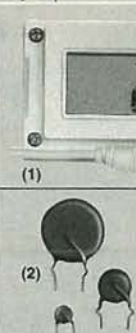

(2) **Set of 100 Ceramic Disc Capacitors.** A variety of popular styles and values at a bargain price. Ratings up to 1000 WVDC. Stock up! #272-801, Set 1.98

(3) **Assortment of 20 Electrolytic Capacitors.** Miniature and submini types in a variety of values with ratings to 50 WVDC. #272-802, Set of 20/1.98

Since 1921 Radio Shack has been the place to obtain up-to-date electronic parts as well as quality tools, test equipment and accessories at low prices. Over 7000 locations to serve you—NOBODY COMPARES

Prices apply at participating Radio Shack stores and dealers. Radio Shack is a division of Tandy Corporation

Radio Shack
 AMERICA'S TECHNOLOGY STORESM

CIRCLE 78 ON FREE INFORMATION CARD

BUILD THIS DRAM TESTER

FRED HUFFT

Build a sophisticated DRAM tester with function, speed, and margin tests for under \$60!

IF YOU SERVICE OR EXPERIMENT WITH personal-computer hardware, you have probably handled a lot of memory circuits, commonly referred to as a "RAM" (random-access memory) or "DRAM" (dynamic RAM). When troubleshooting a PC memory problem, expanding RAM capacity, or upgrading the cycle speed of a memory bank, it can be very helpful to have a way of function testing and measuring the access time or speed of the DRAM IC's. Many intermittent memory failures have been traced to a slow DRAM in the memory bank. On the other hand, some DRAM's will far exceed their minimum access rating and can be speed tested and sorted for faster functions, saving the cost difference to the faster rated parts.

A number of small DRAM testers are available from about \$150 to \$1000, with the less-expensive models not having a lot of features. However, if you are interested in building a multi-featured unit that can function test, accurately speed test, and automatically cycle the tests under high-, low-, or normal-voltage margins, all for less than \$60 (plus enclosure and AC adaptor), then check out this easy-to-assemble DRAM Tester.

Capabilities

The unit can test 64K \times 1, 256K \times 1, or 1MEG \times 1 DRAM's, and can measure speed or access times from 60 to 200 nanoseconds (ns). There is a switch to select a "HI" and "LO" voltage-margin test and three LED indicators that show the current device-under-test (DUT) voltage. There's also a red/green LED that blinks green to show a test is running, displays a continuous green to show a test has run complete without an error, and will display a continuous red when a test is stopped by the detection of an error.

An 18-pin ZIF (zero insertion force) test socket is provided for

1-MEG DRAM's and a 16-pin ZIF test socket is used for the 64K and 256K DRAM's. A pushbutton TEST switch starts a test sequence, which runs about 10 to 14 seconds depending on the access speed. However, a CYCLE switch is provided to continuously recycle the selected test, if desired. When a 1-MEG DRAM is tested, a 0101 data pattern is written to all addresses in the DRAM, then each address is read back and compared for correct

data. An error stop will occur immediately during the read test if the data is not correct.

After the 0101 pattern test, a 1010 pattern is written to all locations, then read back and compared. The two-pattern test is automatically run twice; upon successful completion of the two-pattern double test, the tester stops and indicates a continuous green on the PASS/FAIL indicator.

A 256K DRAM receives the same test except that it's written

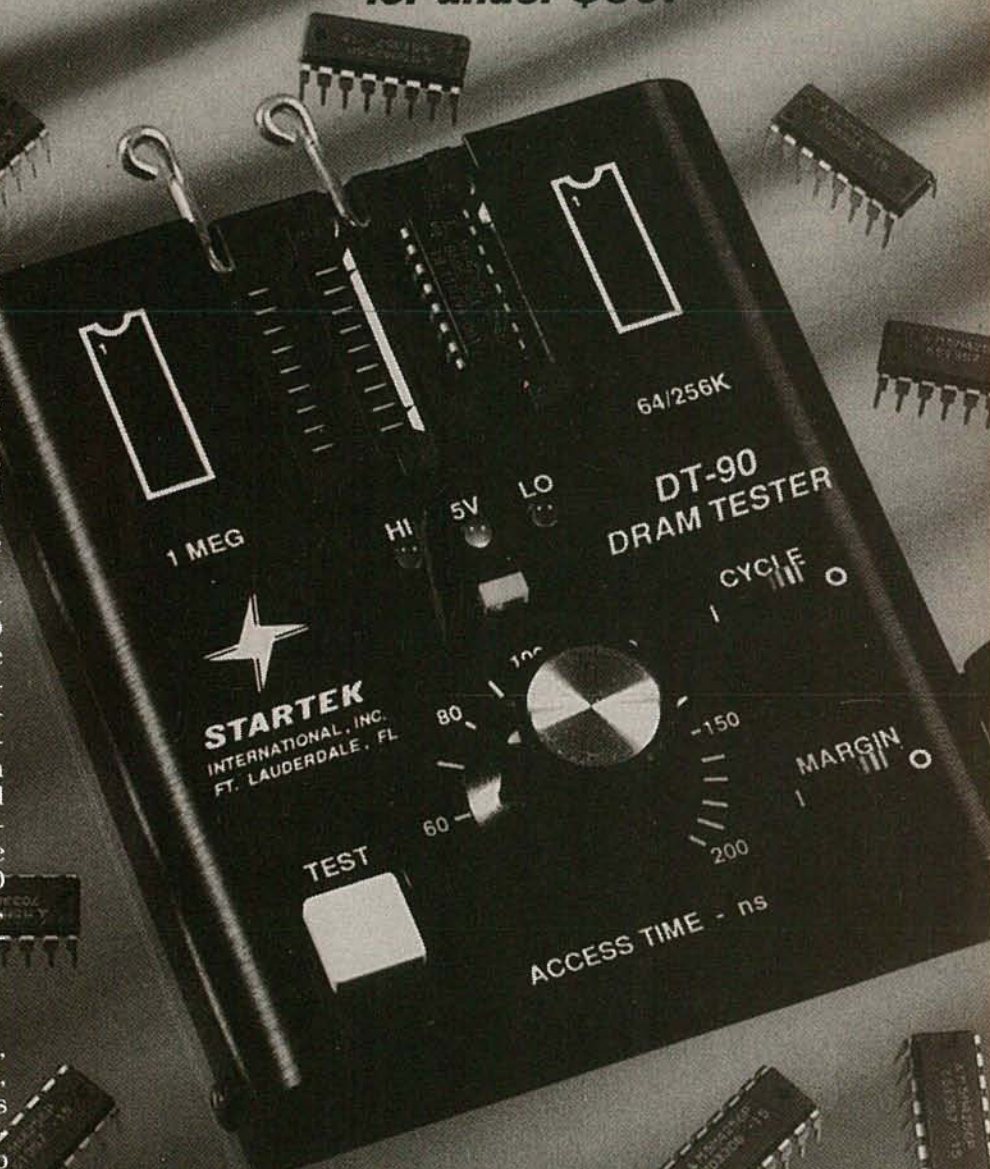

to and read back 4 times during each test and a 64K DRAM receives the write/read test 16 times in each pattern. If the CYCLE switch is on, the test does not stop and will continue until an error is detected. If the MARGIN switch is on, the first two-pattern test cycle will be run at low-margin DUT operating voltage and the second cycle will automatically switch to high-margin DUT operating voltage. Should both the MARGIN and CYCLE switches be on, the tests will alternate from low- to high-margin voltage. All voltage and test signals are applied to both ZIF test sockets simultaneously, but only one DRAM can be tested at a time. DRAM's to be tested can safely be inserted or removed from the ZIF test sockets with the power on.

Dynamic RAM

DRAM's use multiplexed row and column address inputs; 64K DRAM's require only 7 address lines, 256K DRAM's require 9, and 1-MEG DRAM's require 10. Figure 1 shows a block diagram of a typical 256K \times 1 DRAM, and Fig. 2 shows a typical 1-MEG DRAM. Address decoding and address latches are incorporated in the DRAM. To address the DRAM, row-address data is put on all address lines and clocked by the RAS (row address strobe) signal, then the column address data is put on the address lines and clocked by the CAS (column address strobe) signal. DRAM's have a READ/WRITE input pin, usually labeled \bar{W} , to control the type of operation; a DATA IN pin, D; and a DATA OUT pin, Q.

Data is held in dynamic RAM by the charge on internal capacitors. Since the charge degrades with time, the bits need to be "refreshed" or row addressed at approximately every 4 to 64 milliseconds. That is typically done by a RAS-only cycle through the row addresses—a normal read or write cycle will also accomplish the refresh. A 1-MEG DRAM may have a "test function" input (T_F) at pin 4 that allows it to be tested 4 bits at a time; we do not use that function so the T_F input is disabled by tying it to ground.

The timing of the address and strobe inputs is critical. A DRAM's "access time," or speed, is the time from RAS, which is the

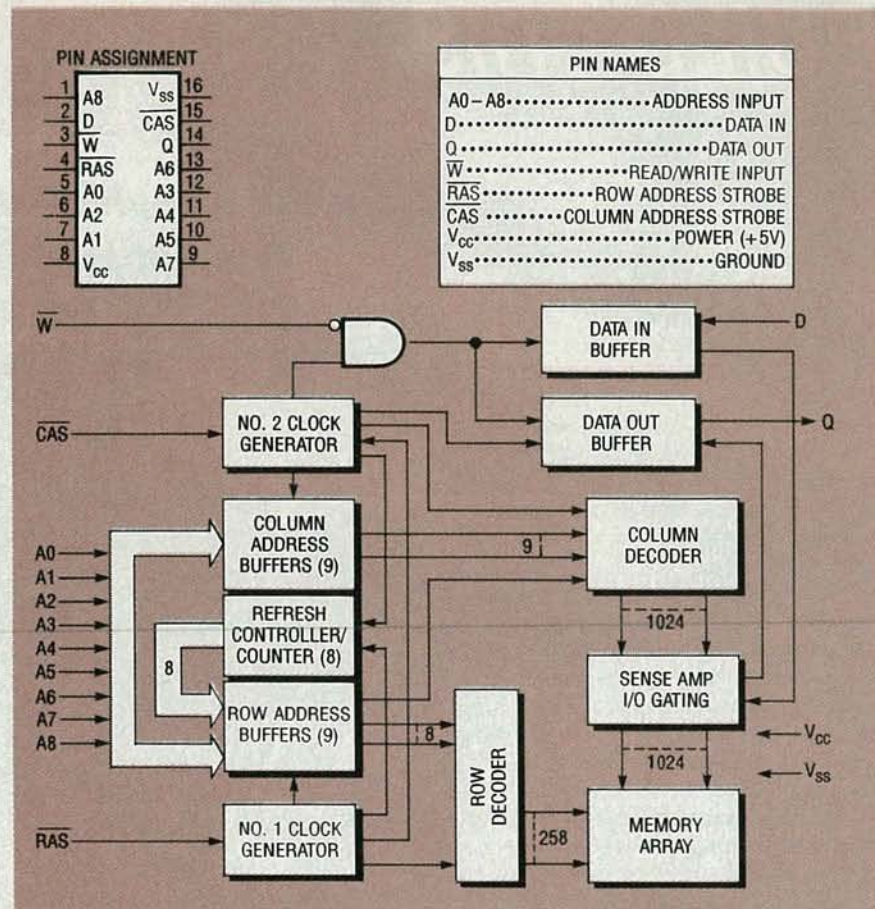

FIG. 1—256K DRAM PIN NAMES AND BLOCK DIAGRAM. DRAM's use multiplexed row and column address inputs; this 256K DRAM requires 9.

TABLE 1

	Parameter
t_{RC}	Random Read or Write Cycle Time
t_{RAC}	Access Time from \bar{RAS}
t_{CAC}	Access Time from \bar{CAS}
t_{OFF}	Output Buffer and Turn-Off Delay
t_{RP}	RAS Precharge Time
t_{RAS}	RAS Pulse Width
t_{CAS}	CAS Pulse Width
t_{RCD}	\bar{RAS} to \bar{CAS} Delay Time
t_{ASR}	Row Address Setup Time
t_{RAH}	Row Address Hold Time
t_{ASC}	Column Address Setup Time
t_{CAH}	Column Address Hold Time
t_{AR}	Column Address Hold Time Referenced to \bar{RAS}
t_{RCS}	Read Command Setup Time

start of the addressing, to the time at which there is valid data at the output pin D. That is very basically how the DRAM works. Figure 3 shows a read-cycle timing chart for a 256K \times 1 DRAM, and Table 1 explains what the timing symbols mean.

Circuit description

The DRAM tester uses two voltage-regulator IC's and only six logic IC's, thanks to the use of two PLD's (programmable logic devices) which replace about ten individual IC's. Refer to the block diagram in Fig. 4 and the sche-

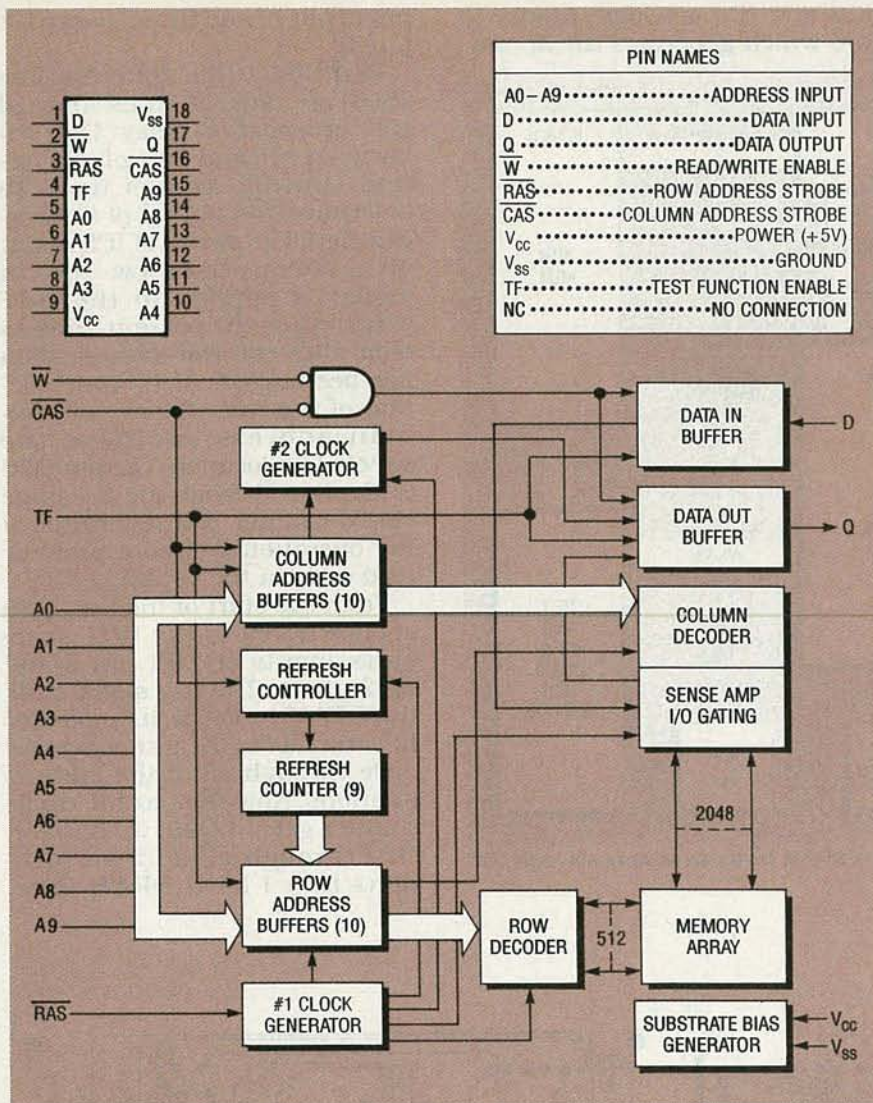

FIG. 2—1 MEG DRAM PIN NAMES AND BLOCK DIAGRAM. Address decoding and address latches are incorporated in the DRAM.

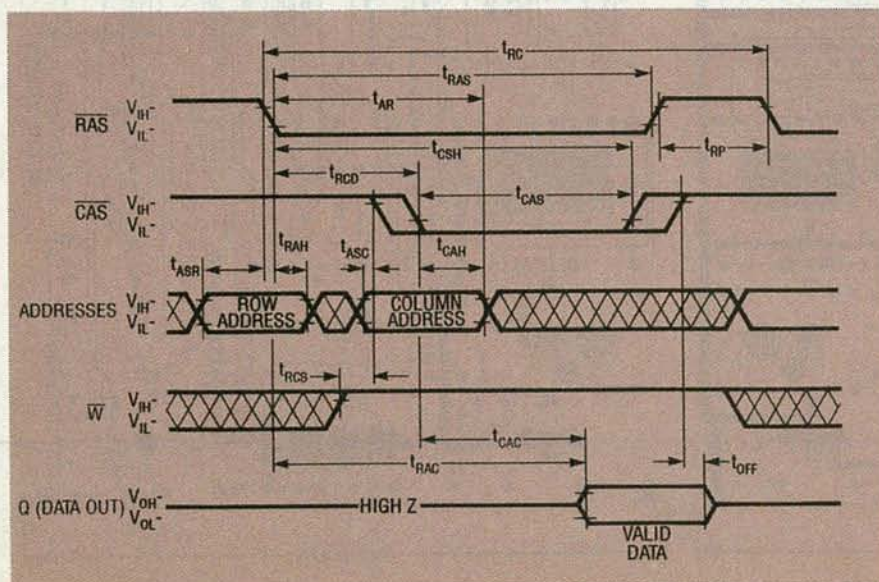

FIG. 3—DRAM READ CYCLE AND TIMING DIAGRAM for a 256K × 1 DRAM. Table 1 explains what the timing symbols mean.

matic in Fig. 5. An AC power adaptor supplies 9 volts DC at 150 mA to a full-wave bridge rectifier made up of D5–D8, which provide automatic input-polarity protection. The 5-volt regulator, IC7, supplies power to everything but the DUT (device under test). DUT power is supplied by IC8, an LM317LZ adjustable regulator which is controlled by logic in the PLD, IC5. For a normal test, IC8 outputs 5 volts to the DUT. Otherwise, 4.5 volts is supplied for the low-margin test and 5.6 volts for the high-margin test.

As mentioned before, IC6 and IC5 are TTL PAL devices; IC5 is an MMI/AMD PAL16L8B-2CN low-power, 25-ns device that contains the oscillator circuitry for our system clock. Components R15, R16, C12, and C5 are also part of the oscillator. The additional components R14, R5 (the access-time potentiometer), R19 (the calibration trimmer), and R17 (the dial-spread trimmer) form the speed-test circuit which varies the basic system clock.

The clock output at IC5 pin 15 is fed into IC6 pins 1 and 6. When the START TEST switch S1 is pressed, a START/RESET signal is generated through R7, C2, and R8 which resets IC2 and IC3 at pin 11; the signal is also applied as an input to IC6 pin 8. Logic in IC6 will gate an output clock signal, designated CLK1, at pin 14. That drives pin 10 of IC2 which is part of a 24-stage ripple-carry binary counter consisting of two 74HCT4040's (IC2 and IC3). As the clock increments the IC2/IC3 ripple counter, the Q0–Q7 and Q10–Q17 outputs drive IC1 and IC4, which are 74HCT257 quad 2-input multiplexers.

Multiplexers IC1 and IC4 each select four bits of data from two different sources under the control of a common select input at pin 1. Logic in IC6 generates the RAS signal which is input at pin 3 of IC5, present at pin 3 of test-socket ZIF1 and pin 4 of ZIF2, and is also the input select signal at pin 1 of IC1 and IC4. The outputs of IC1 drive address lines A0–A3 and the outputs of IC2 drive A4–A7 of the DUT at test sockets ZIF1 and ZIF2. A 256K DRAM requires an additional address line, A8, and a 1-MEG DRAM requires two additional address lines, A8 and A9. To gen-

erate the A8 and A9 address lines, Q8, Q9, Q18, and Q19 from

IC2 and IC3 are logic inputs to IC6 which generates the A8 out-

put at pin 19 and the A9 output at pin 12.

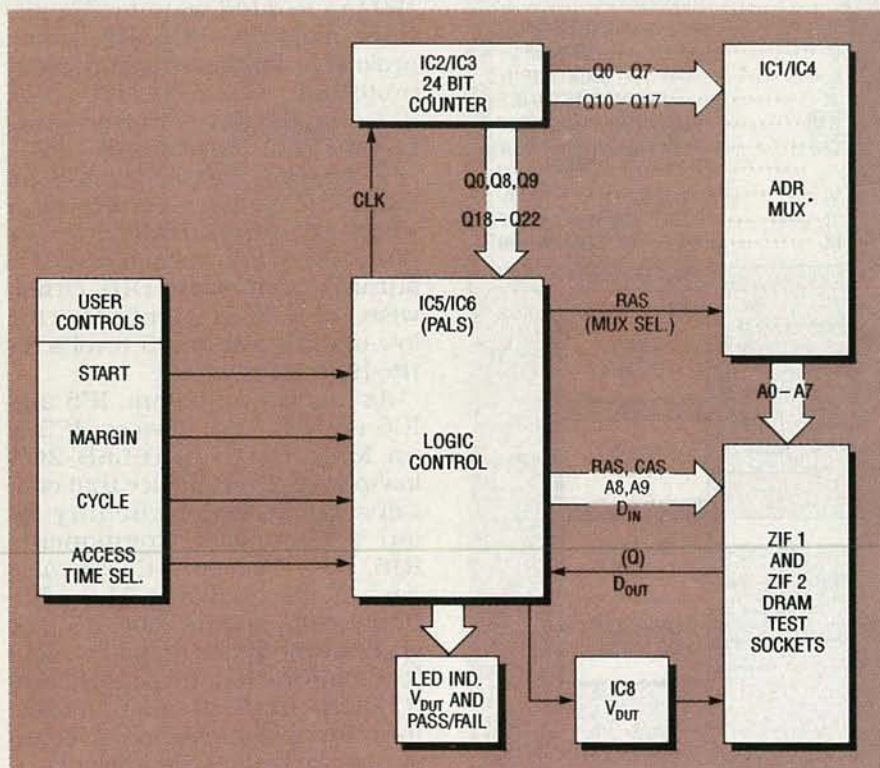
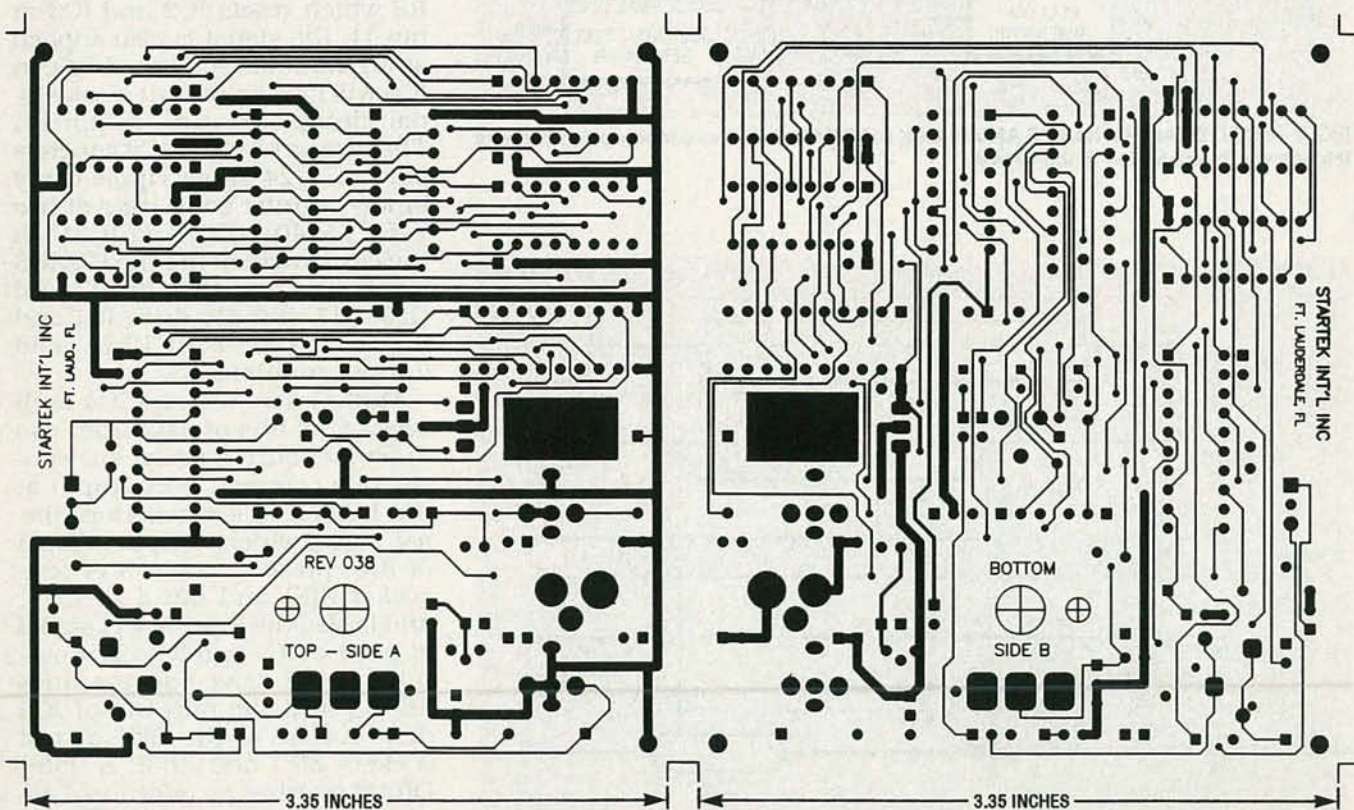

FIG. 4—DRAM TESTER BLOCK DIAGRAM. The DRAM tester uses only six logic IC's, thanks to the use of two PLD's.

Both PAL's (the 16R4 and the 16L8) are rated at 25-ns internal gate propagation delay. That delay is an integral part of the system timing, and is used to determine the timing of the low CAS signal at pin 12 of IC5 about 40 ns after RAS goes low. The CAS signal is applied to the DUT which gates the column-address data after the row-address data has been gated. At the intersection of the row address and column address, we have the selected bit location. Output Q20 (IC3 pin 12) from the 24-stage ripple counter will determine if the operation will be a write or read cycle in the DRAM.

From the start of the test, Q20 applies a low to the DUT READ/WRITE inputs at ZIF1 pin 2 and ZIF2 pin 3. The low signal puts the DRAM in the write mode for the first half of the test, where we cycle through all of the address locations. Note that, as the ripple counter gets to Q20, we have cycled through all address locations in a 1-MEG DRAM once,



TOP, OR COMPONENT SIDE of the DRAM tester PC board. Parts are actually mounted on both sides of the board.

BOTTOM, OR SOLDER SIDE of the board.

FIG. 5—DRAM TESTER SCHEMATIC. The 5-volt regulator, IC7, supplies power to everything but the DUT, which is powered from IC8, an LM317LZ adjustable regulator. IC8 normally outputs 5 volts to the DUT; 4.5 volts is supplied for the low-margin test and 5.6 volts for the high-margin test.

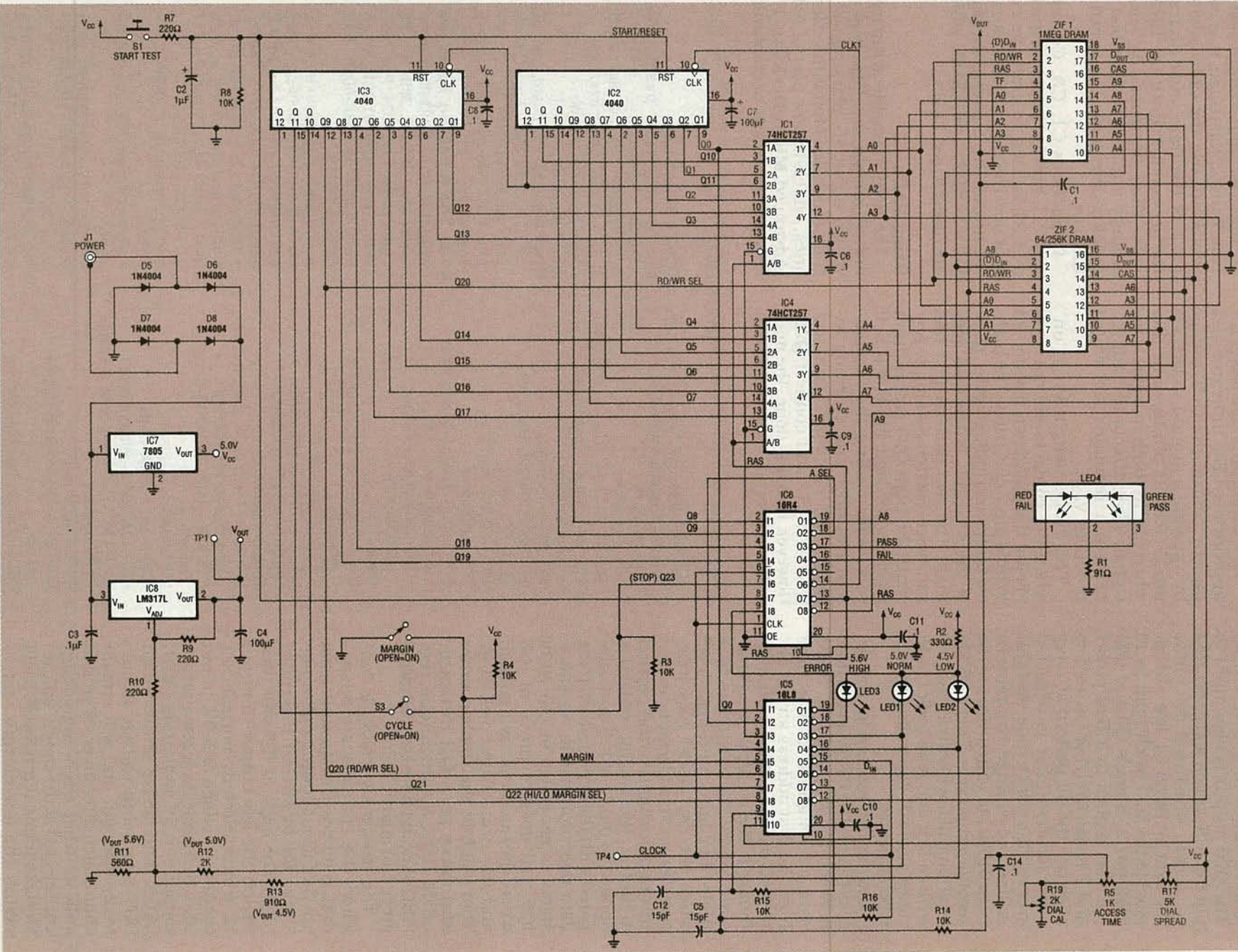

four times in a 256K DRAM, and sixteen times in a 64K DRAM. The Q20 output is also input to pin 6 of IC5, which will generate a D_{IN} signal, which will determine the data bit (high = 1, low = 0) applied to the DUT at ZIF1 pin 1 and ZIF2 pin 2. Signals Q0 and Q21 are also applied to IC5 at pins 1 and 7 respectively; Q0 is used to alternate the bit pattern at every other location as it is triggered every cycle or clock time, and Q21 is used to change the pattern from 010101 to 101010 during the second write cycle. Every DRAM location will have both a 1 and a 0 written to it and read back 1 to 16 times per test, depending on the type of DRAM.

During the read cycle, the access time of the DRAM is the time between the RAS and D_{OUT} (valid data out) signals, or the time from the first address strobe until valid data is at the Q output of the DUT. The Q output is a three-state signal that switches to a high-impedance mid-logic level when the CAS signal goes inactive. As each address is cycled through during the read portion of the test, the data bit read out is applied to pin 11 of IC5 and compared with the expected bit. If the data does not match, an ERROR signal is generated at pin 19 of IC5 that goes to pin 9 of IC6 where the FAIL output will go high and the CLK1 output will stop. That will halt the ripple counter and make pass/fail indicator LED4 light a continuous red. (LED4 should have been blinking green during the test.)

The MARGIN switch S2 is "on" when the contacts are open—that removes the ground from pin 5 of IC5, allowing pull-up resistor R4 to switch the input high. The logic in IC5 will then switch the low output from pin 17, which selected a normal DUT operating voltage of 5.0V, to pin 16, which selects a low-margin voltage of 4.5V. Indicators LED1, LED2, and LED3 show which DUT operating voltage is currently selected, and will remain illuminated after an error stop to indicate what operating voltage was selected at the time of failure. The Q22 input at pin 8 of IC5 will switch the low-margin test to high, and select the pin-18 output of IC5, which lights LED3 to indicate a high-margin operating

voltage of 5.6V.

The IC5 outputs that select the appropriate LED indicator also directly control the DUT voltage by applying a ground to R12 via pin 17, R13 via pin 16, or neither when pin 18 (high margin) is selected. That affects the adjustment pin regulator IC8 which produces V_{DUT} .

The CYCLE switch S3 is "on" when the contacts are open, allowing the pull-down resistor R3 to hold pin 7 of IC6 low. The highest bit in our ripple counter, Q23, is the STOP bit. When Q23 goes high, the two-pattern test has run twice. Switch S3 simply prevents the high Q23 output from reaching the logic input of IC6. If you prefer cycling the two-pattern test once and stopping instead of twice, simply disconnect Q23 from S3 and connect Q22. However, if that is done, the margin test would have to be run

with the CYCLE switch also "on" so that the high-margin test is run. With actual usage, it is convenient to use the CYCLE switch most of the time. Just increase the access time until the DRAM fails, then decrease the speed slightly and restart the test to quickly determine the speed of the part.

Capacitors C1, C3, C6, and C8–C11 are for power bypass, and R1 is used to limit the current flow through LED4. Resistor R2 limits the current through LED1, LED2, and LED3, which are discrete red LEDs.

Using PAL's

The programmable array logic device, known as a PAL, was invented about 15 years ago at a company called Monolithic Memories, which is now part of AMD (Advanced Micro Devices). The PAL provides a way of combining

PARTS LIST

All resistors are ¼-watt, 5%, unless otherwise noted.

R1—91 ohms
R2—330 ohms
R3, R4, R8, R14–R16—10,000 ohms
R5—1000 ohms, linear taper potentiometer
R6, R18—not used
R7, R9, R10—220 ohms, 1%
R11—560 ohms
R12—2000 ohms, 1%
R13—910 ohms
R17—5000 ohms, 4-turn trimmer potentiometer
R19—2000 ohms, trimmer potentiometer

Capacitors

C1, C3, C6, C8–C11, C14—0.1 μ F, monolithic
C2—1 μ F, tantalum
C4, C7—100 μ F, electrolytic
C5, C12—15 pF, monolithic

Semiconductors

IC1, IC4—74HCT257 quad 2-channel three-state multiplexer
IC2, IC3—74HCT4040 12-stage binary counter
IC5—AMD 16L8B-2 PAL
IC6—AMD 16R4A-4 PAL
IC7—LM7805 5-volt regulator
IC8—LM317LZ low-power adjustable regulator
D1–D4—not used
D5–D8—1N4004 1-amp rectifier diode
LED1–LED3—red light-emitting diode, ½-inch diameter
LED4—red/green 3-lead common-cathode LED module

Other components

S1—normally-open pushbutton switch
S2, S3—SPDT sub-mini slide switch
J1—2.1 mm DC power input jack
ZIF1—18-pin ZIF socket
ZIF2—16-pin ZIF socket

Miscellaneous: PC board, four 16-pin IC sockets, two 20-pin IC sockets, knob for R5, cabinet, 120-VAC-to-9-VDC 300-mA wall adapter, solder, etc.

Note: The following items are available from Startek International Inc., 398 NE 38th St., Ft. Lauderdale, FL 33334. For information call (305) 561-2211, for orders call (800) 638-8050, FAX (305) 561-9133.

- Complete DRAM tester kit including programed PAL's (does not include cabinet and AC adaptor), KIT #DT-90K—\$59.95.
- Complete DRAM-tester kit including programed PAL's, cabinet, and AC adaptor, KIT #DT-90CK—\$89.95.
- PC board only, #DT-90PCB—\$18.00.
- Programed PAL's—\$7.50 each.
- A factory assembled, calibrated, and tested DRAM tester—\$119.00.

Add 5% shipping/handling charge (\$4.00 minimum, \$10.00 maximum.) Florida residents must add sales tax. VISA, MC and COD-CASH orders accepted.

a number of discrete logic IC's in a single custom-programmed IC. The PAL device has a programmable AND array followed by a fixed OR array. In the DRAM-tester circuit we use two very common PAL's, a 16L8 and a 16R4. Both are low-power devices, and relatively inexpensive.

The use of PAL's results in reduced parts count and power consumption, a smaller PC board, faster logic, increased reliability, and, usually, overall reduced cost. A reduced parts count means less-complex PC boards are required, and circuit changes can frequently be made in the PAL program without affecting the PC board. On the down side, designing with PAL's does require support tools consisting of design software and a device programmer. (Those items are needed by the circuit designer; the builder does not require those items, as programmed PAL's are available from the source listed in the parts list.) The PAL design software provides the link between high-level logic expressions and the low-level programming details which the device programmer uses.

In our circuit, IC5 (a 16L8 PAL) has 10 dedicated inputs, 2 dedicated outputs, and 6 combinatorial input/output pins. IC6 is a 16R4 PAL which has a 4-bit register, a clock register input, 8 dedicated inputs, 4 registered outputs with an output-enable pin, and 4 combinatorial input/output pins. Both are 20-pin DIP TTL devices, which are one-time programmable by opening fuse links (with an appropriate device programmer) to configure the AND and OR gates within the device. The PAL devices implement the Boolean logic transfer function, the sum of the products. The AND array creates custom product terms, while the OR array sums selected terms at the outputs of the device.

Figure 6 shows the pinouts for the 16L8 and 16R4 PAL's with the input/output signals and logic equations used to generate each output. Figure 7 shows the logic diagram for the 16L8 and Fig. 8 shows the 16R4. A PAL is manufactured with all "fuses," or connections intact. The undesired fuses are blown open by the programmer, leaving only the desired

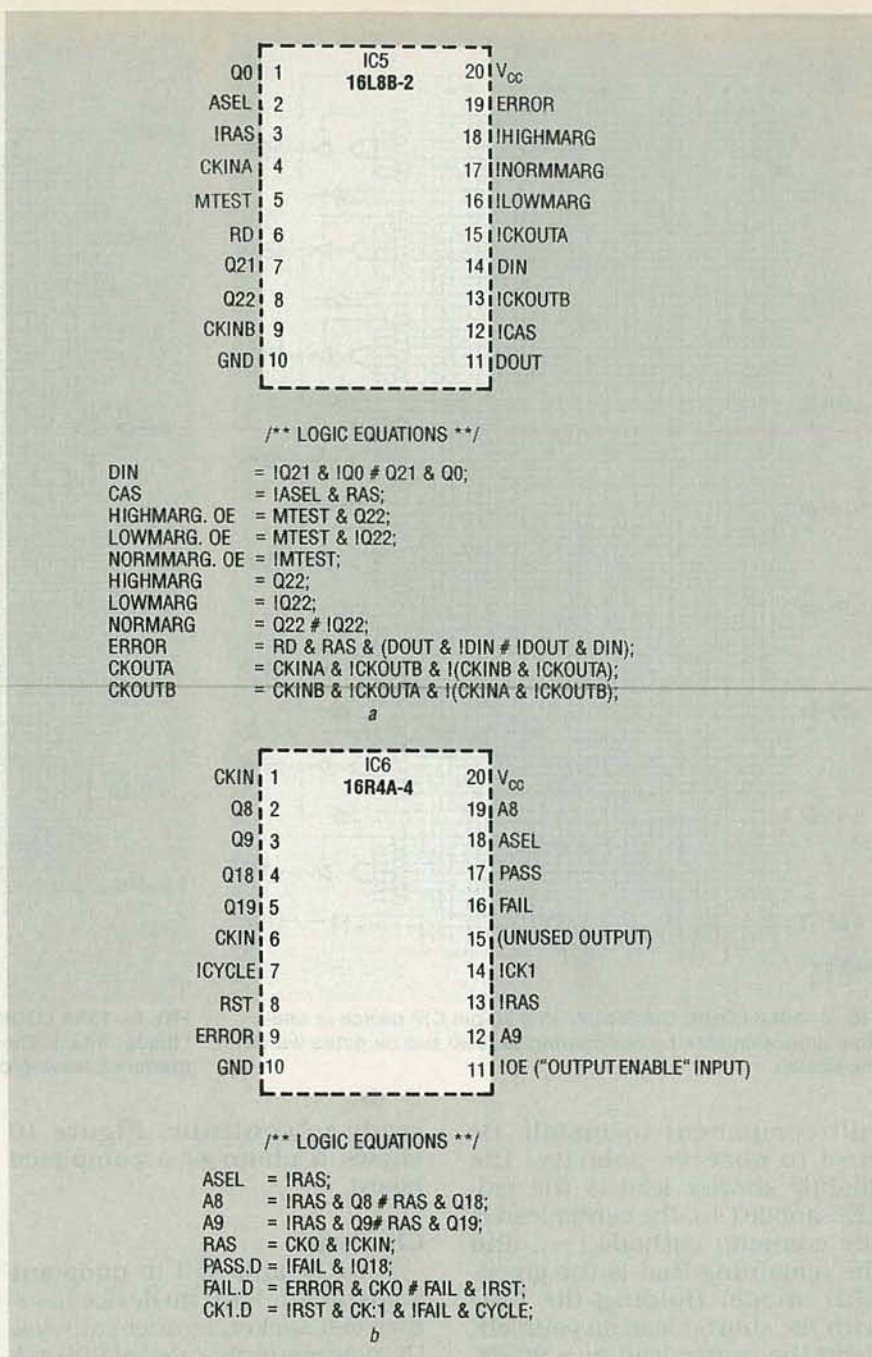

FIG. 6—PAL PINOUTS AND LOGIC EQUATIONS. 6-a shows the pinouts for the 16L8 and 6-b shows the 16R4. The logic equations are used to generate the outputs.

ed logic connections.

Assembly

The DRAM tester is easy to assemble. Parts are installed on both sides of a double-sided plated-through PC board measuring 3.35 × 3.8 inches. Programmed PAL's, as well as the other parts including the PC board, are available from the source listed in the parts list. The professional-looking case you see is also available at extra cost. Parts assembly order is not critical, however, it's recommended that you install all resistors first, then di-

odes, IC sockets (not including the ZIF sockets), IC7 and IC8, and then the capacitors. Follow Fig. 9 for correct placement of parts.

Next install power-jack J1, and switches S1, S2 and S3. Be sure S2 and S3 are straight so that they will properly fit in the cabinet openings. Next install potentiometers R5, R17, and R19; R5 mounts under the PC board with the pins bent upward to fit the connection holes from under the PC board.

The two-color (red/green) LED (LED4) is probably the most diffi-

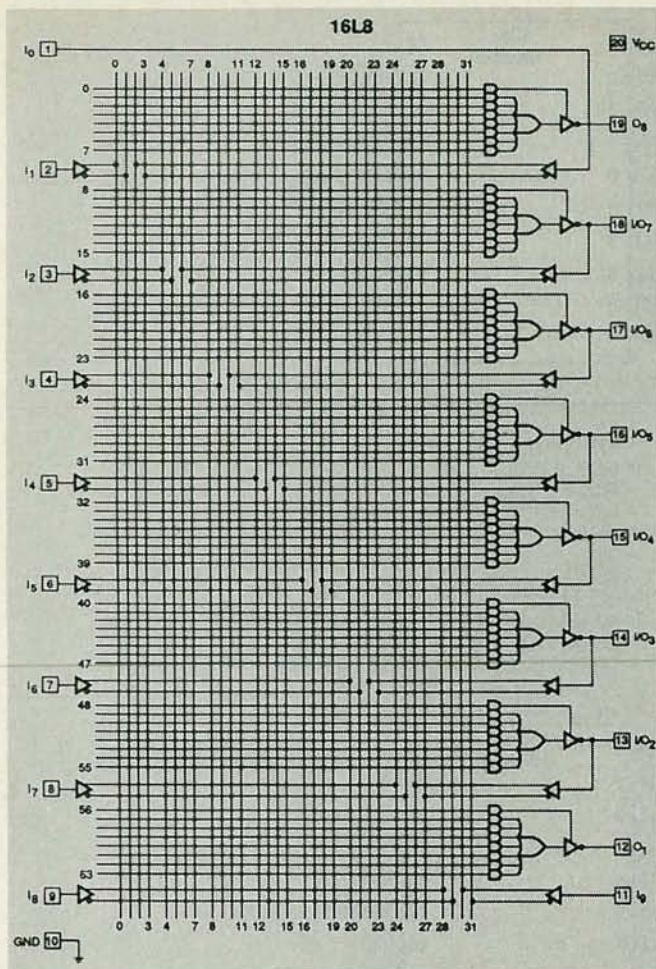

FIG. 7—16L8 LOGIC DIAGRAM. This 20-pin DIP device is one-time programmable by configuring the AND and OR gates within the device.

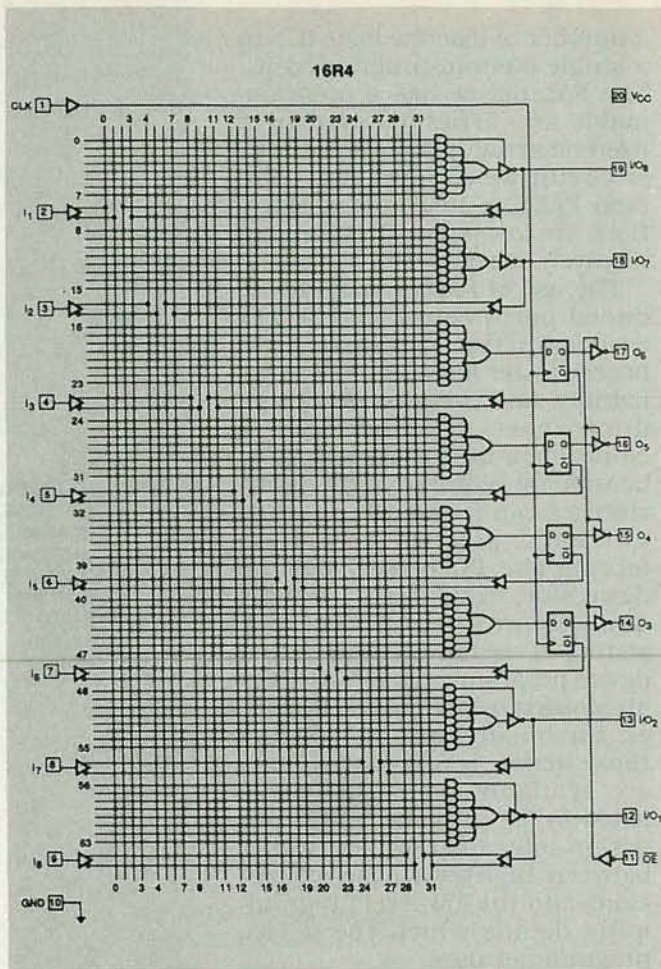

FIG. 8—16R4 LOGIC DIAGRAM. A PAL is manufactured with all "fuses" intact. The undesired fuses are blown open by the programmer, leaving only the desired logic connections.

cult component to install. Be sure to observe polarity; the slightly shorter lead is the red-LED anode (+), the center lead is the common cathode (-), and the remaining lead is the green-LED anode. Holding the LED with the shorter lead on your left, bend the center lead at a 90-degree angle, snug against the component body, toward yourself, and likewise bend the other two leads in the opposite direction, spreading them slightly. Align LED4 over the proper PC-board location and bend the three leads down to fit the holes. Check for proper alignment with the cabinet before soldering.

Install LED1, LED2, and LED3. Note that the flat side of the LED's is the cathode. Allow the LED's to stand about 7/32-inch above the PC board. Install the two ZIF sockets and insert IC1-IC6 into the appropriate sockets. Recheck all component connections and polarities. If you are satisfied that everything looks correct, you're

ready to continue. Figure 10 shows a photo of a completed board.

Checkout

Set R17 and R19 to midpoint adjustment. With no device in either test socket, connect a 9-volt DC power supply, rated at 200 mA or more (the actual current draw will be about 150 mA), to J1. (The polarity does not matter as we have a diode-bridge power input.) A continuous red should be displayed on LED4, the pass/fail indicator.

Using a DC voltmeter, make the following measurements. (Note that a ground pad is located in each corner of the PC board.) These voltages should be within ± 0.1 volt:

- IC7 pin 3 (V_{CC}) should be 5.0V.
- With the MARGIN switch (S2) off (slider to right), measure V_{DUT} at TP1. It should be 5.0V.
- With the MARGIN switch on, the low-margin DUT voltage indicator should be on and TP1 should

measure 4.5V.

- Place a DRAM IC in the appropriate ZIF test socket, turn the access-time potentiometer (R5) fully clockwise and press test-switch S1. If the device under test is good and the tester is working properly, LED4 will blink green and, if the MARGIN switch is on, the tester should alternate between high- and low-margin voltages. If you do not get a correct indication, try a power off and on reset. Turn on the CYCLE switch (slider to the left) and the tester should repeat the test without having to press the TEST button.
- When the high-margin voltage indicator LED3 is on, the voltage at TP1 should be 5.6V.

If all of the above voltages check out properly, only the "speed" or access-time calibration remains. If you have access to a 100-MHz oscilloscope, look at TP4 with no IC in either test socket. That is the master clock and it should run continuously. Allow the unit

continued on page 60

DAVID PLANT

THERE IS AN OLD AXIOM THAT A MAN'S work is only as good as his tools—and a good pulse generator is always a good tool to have. Those of us who don't often need pulse generators—the technician working at home on a project, for example—can usually get by with a 555 timer added to a prototype board and used as a trigger. But there's not always enough room on the board to do that, and it is always a pain in the neck.

The solution to that problem is our Pulse-Mate, a compact single-shot and continuous-pulse generator. The easy-to-use design has automatic level setting and positive and negative pulse output. It can be powered from the device under test in the range from 4.5 to 18 volts DC, and has short-circuit protection for itself and the device under test.

The circuit

Referring to Fig. 1, the circuit basically has three sections. Foremost is the actual pulse generator built around the ubiquitous 555 timer, which can be switched from monostable mode (one shot) to astable mode by S2. The value of R8 is selected to create an approximate square wave at mid frequency range and R11 selects the actual rate desired. With S2 in the "astable" position, R11 and C2 give a range of about 5- to 200-Hz., which will satisfy most needs. (Note that S2 is part of potentiometer R11.) If you need to generate higher frequencies, a reduction of C2 can bring the range up well above audio, but at a loss of the low-frequency pulsing which can be quite handy.

With S2 in the "one shot" position, pushbutton S1 will trigger IC1 for as long as it is held down. The timer's trigger input (pin 2) is held high by R1 to prevent false triggering from hand capacitance. When the trigger pin is brought to ground by S1 or keyed by the discharge pin (pin 7) in the astable mode, pin 3 goes high to about 3.3 volts (when IC1 is powered from 5 volts). For better circuit stability, power to IC1 is regulated.

The second section of the circuit consists of Q1 and Q2 which

provide the high-rise-time pulse required for digital work. When Q1 is turned on by the positive output of IC1, its collector goes low, giving a negative output pulse at the probe if S3 is in the "low" position. The low output from Q1 also turns Q2 off; Q2's collector now goes high, which provides a positive pulse at the probe if S3 is in the "high" position. Transistor Q2 also drives Q3, which drives indicator LED1.

Because Q1-Q3 operate at the incoming supply voltage, we strongly recommend that you use 2N4400 or equivalent transistors rather than garden-variety NPN's, as their base-emitter drop is less and they have a faster rise-time. The Pulse-Mate's output waveform is shown in Fig. 2. The probe current is limited to under

5 mA by R6 to protect both the device under test and the Pulse-Mate.

The third section consists of a voltage regulator consisting of Zener-diode D1 and Q4. That configuration was used rather than the popular three-terminal devices, such as the 7805, because, when powered from 5 volts, the regulator's internal voltage drop wouldn't leave enough to power IC1. As the supply voltage increases beyond 6.2 volts, the Zener diode conducts and limits Q4's output to 6 volts for IC1.

Construction

A parts-placement diagram is shown in Fig. 3, and we have provided the foil pattern for the PC board if you would like to make

PULSE-MATE

This single-shot and continuous-pulse generator is inexpensive and easy to build, yet it offers automatic level setting and both positive and negative pulses.

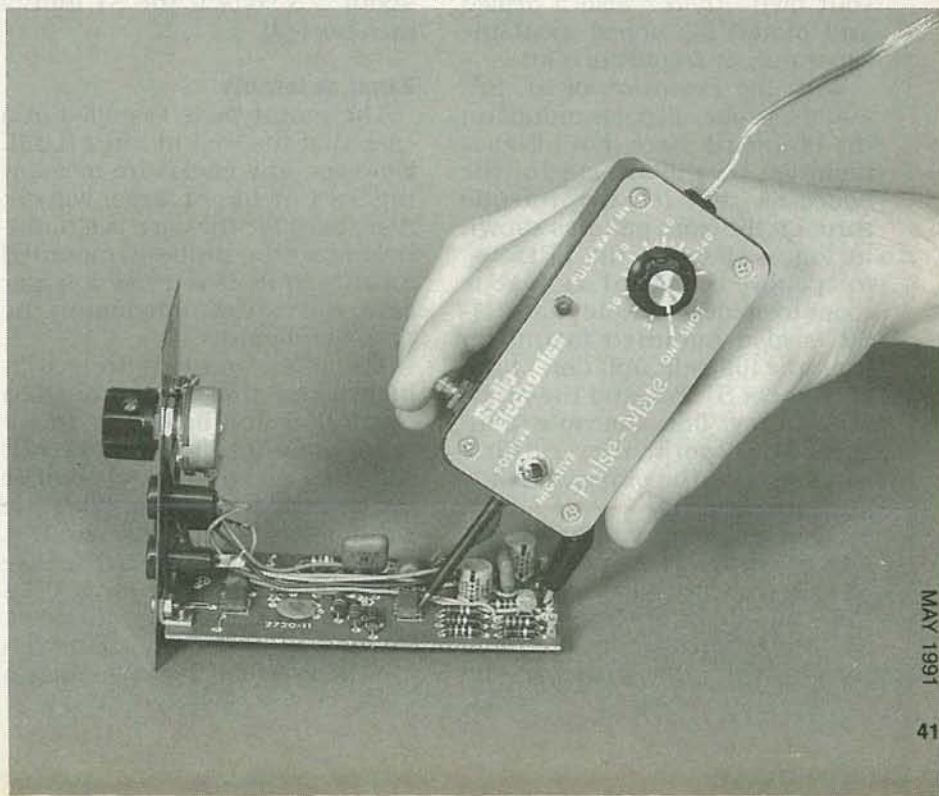

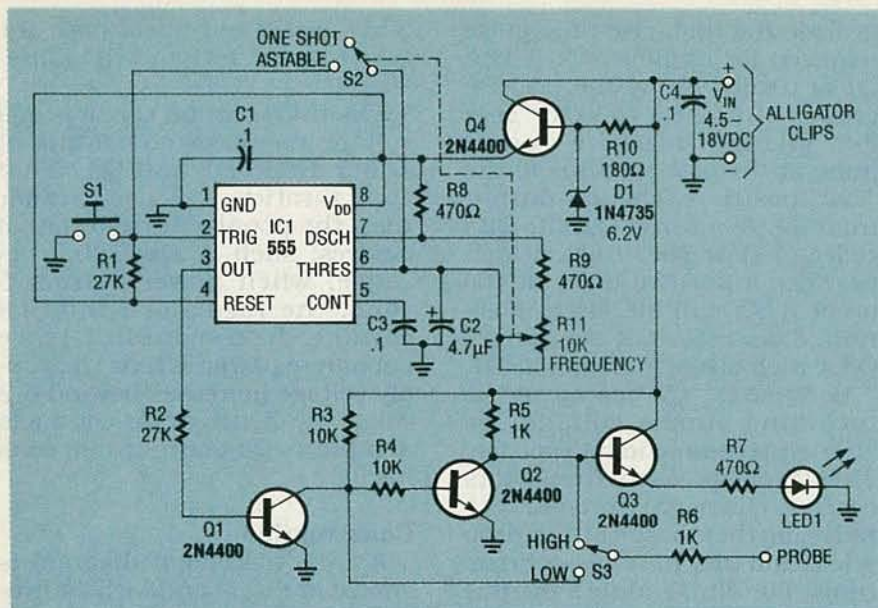

FIG. 1—THE CIRCUIT HAS THREE SECTIONS: the pulse generator built around the 555 timer, Q1 and Q2 which provide the high-rise-time pulse required for digital work, and a voltage regulator consisting of Zener-diode D1 and Q4.

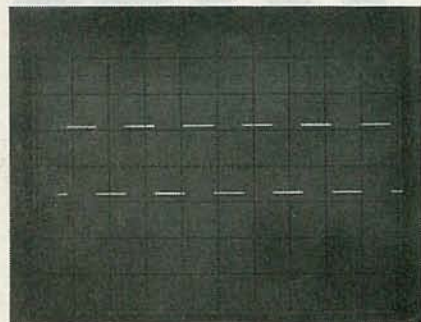

FIG. 2—THE 2N4400 TRANSISTORS have a fast rise-time; here's what the output waveform looks like.

your own—there's also a drilled and plated PC board available separately or as part of a kit.

With the exception of S1, S3, and the probe, all parts mount on the PC board. Note that LED1 is mounted on the foil side of the board so that it can protrude through the front panel as shown in Fig. 4. (Mount the LED $\frac{3}{16}$ -inch above the board so there is room to solder it.) Note that R11-S2 is also mounted facing up from the foil side. You don't have to connect S1, S3, and the probe at this time. Take a minute to inspect your work; if everything looks alright, the project is ready for initial testing.

Observing proper polarity, connect 5 volts DC to the board. With R11-S2 in the "off" position, LED1 should be off. Shorting the S1 inputs with a clip lead will turn on the LED. If there is no

light, check the LED's polarity and the mounting of Q1-Q4. Pin 8 of IC1 should show 4.5 VDC, Q1's collector should be low (100 mV or less), and Q2's collector should be high (roughly 5 volts). Now check the output pulse by putting S2 in the "on" position. The LED will flash at about 5 Hz, and advancing potentiometer R11 will increase the flash rate to the point where the LED will appear to be continuously lit. If there is no flashing, check the output of IC1 pin 3 for a positive pulse (or a continuous high of about 3.3 volts if the S1 inputs are shorted).

Final assembly

The prototype is installed in a case that fits well in one's hand. However, any enclosure measuring 2×4 inches or larger will do. Also, because the case is a hand-held size, the probe is mounted directly to it. If you use a larger case, you may want to mount the probe off-board.

The probe is made from a 2-inch screw that is ground to a point after first fitting on an appropriate nut; removing the nut will then deburr the screw after the tip is ground down. With one washer fitted over the screw, it is passed through a hole in the case and the nut then secures it in place (don't tighten it right now). By the way, be careful when drilling the holes in the case; once a

PARTS LIST

All resistors are $\frac{1}{4}$ -watt, 5%

R1, R2—27,000 ohms
R3, R4—10,000 ohms
R5, R6—1000 ohms
R7-R9—470 ohms
R10—180 ohms
R11—10,000-ohm linear potentiometer with switch

Capacitors

C1, C3, C4—0.1 μ F, ceramic disc
C2—4.7 μ F, 16 volts, electrolytic

Semiconductors

IC1—LM555 timer
Q1-Q4—2N4400 NPN switching transistor
D1—1N4735 6.2-volt Zener diode, or equivalent
LED1—any color light-emitting diode

Other components

S1—momentary pushbutton switch
S2—SPST switch (part of R11 in prototype)

S3—SPDT toggle switch

Miscellaneous: project case (Radio Shack #270-220 or equivalent), knob for R11, 2-inch screw with washer and nut for probe assembly, red and black insulated alligator clips, rubber grommet, heat-shrink tubing, wire, solder, etc.

Note: The following items are available from Project-Mate, 2727 West Manor Pl., Suite 207, Seattle, WA 98199 (206) 283-4700: A kit containing a PC board and all parts including probe hardware, grommet, heat-shrink tubing, alligator-clip assemblies, and front-panel artwork (does not include S1, S3, project case, and knob) is \$24.50 plus \$2.50 shipping and handling. A PC board only is \$6.00 plus \$2.50 shipping and handling. WA residents must add 8% sales tax.

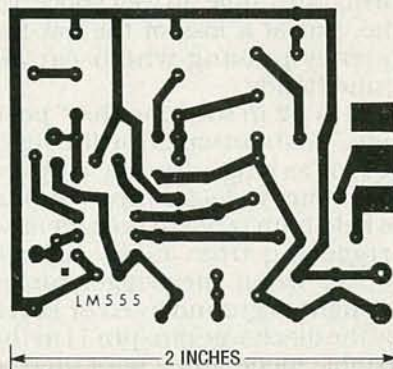

HERE'S THE FOIL PATTERN for the Pulse-Mate's single-sided PC board.

hole is made, it's there to stay. The leads of R6 should be insulated with heat-shrink tubing,

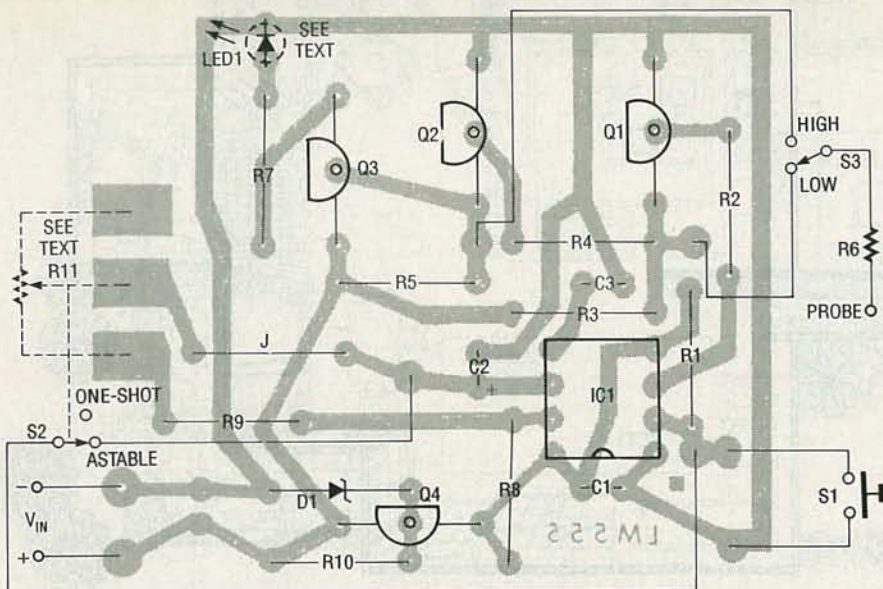

FIG. 3—PARTS-PLACEMENT DIAGRAM. Note that LED1 and R11-S2 mount on the foil side of the board.

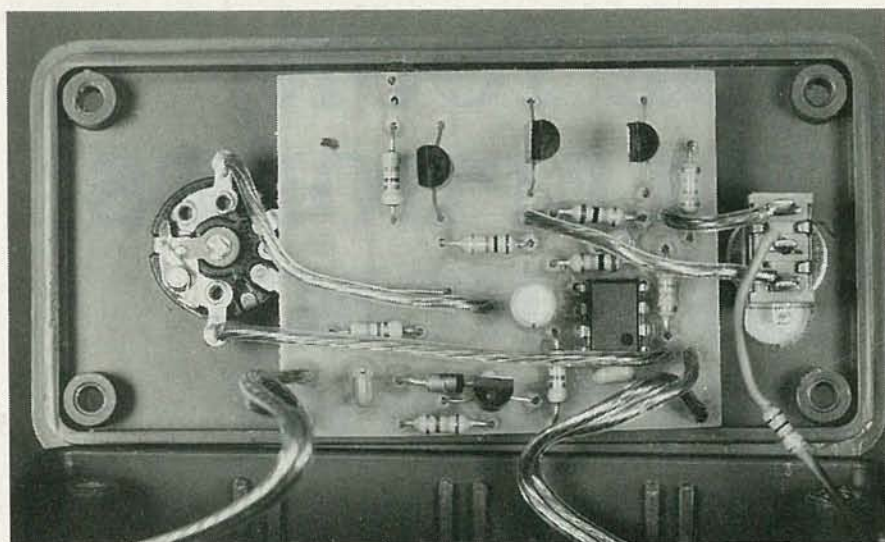

FIG. 4—IT'S A TIGHT FIT, but you end up with a neat little handheld instrument. Notice how LED1 is mounted on the foil side of the board and protrudes through the front panel.

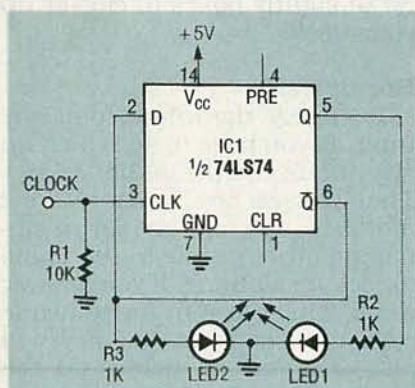

FIG. 5—THIS TEST CIRCUIT uses a 74LS74 positive-edge-triggered flip-flop. Triggering the clock input by hand causes the LED's to change state in an erratic manner. Triggering it with the Pulse-Mate causes the LED's to switch back and forth predictably.

except for the ends; one end is secured between the head of the probe screw and the washer, and the nut can then be tightened. The other end of R6 is soldered directly to the common terminal of S3. Leaving the sharpened tip of the probe screw exposed, cover the length of it with heat-shrink tubing.

Connect S3 and S1 to the board; the lead length depends on the case you use. The power leads on the prototype are arbitrarily 24 inches long. They are soldered to the board then passed through a grommet in the case. Attach the alligator clips to the power leads; use red and black insulators for positive and negative, respectively. The circuit

board is secured to the front panel of the case by the mounting hardware of potentiometer R11 and the wiring to S3. You can also use separate mounting hardware if you like.

You may want to make a nameplate as a finishing touch for the project, although it's best to make sure the circuit is working properly before labeling. At any rate, the one on the prototype was made using an aluminum nameplate kit sold by Kepro Circuit Systems, Inc. (630 Axminister Dr., Fenton, MO 63026). With it, a full-sized positive is made by transferring black press-on type and other designs to a clear piece of acetate. A blue panel (cut to 1/2" over-size) is contact exposed—like a photosensitized PC board—and developed. The unexposed portions under the transfer patterns are washed away leaving a blue panel with white lettering. Of course labeling can also be done in a variety of other ways including engraving, rub-on decals, adhesive labels, etc.

Application

The device can be tested using a spare LED. For a positive-pulse test, connect the cathode of an LED to ground and connect the probe to its anode. Pressing S1 will light the diode. For a negative-pulse test, connect the LED's anode to 5 volts and its cathode to the probe and press S1 to light. (Note that the LED will not light to full brightness in this part of the test because R6 limits the probe current to 5 mA.)

If you want to further test the device, build the simple circuit shown in Fig. 5 using a 74LS74 positive-edge-triggered flip-flop. When power is applied, one of the LED's will light. Stroking the clock input with +5 volts in series with a 1K resistor should cause the LED's to change state. (They will, but in an erratic way because it's virtually impossible to generate a clean clock pulse by hand. Now connect the Pulse-Mate's probe (positive mode) directly to the circuit and the LED's will switch back and forth predictably. You now have a useful piece of test equipment for troubleshooting, project building, digital experimenting, and whatever else you can think of. R-E

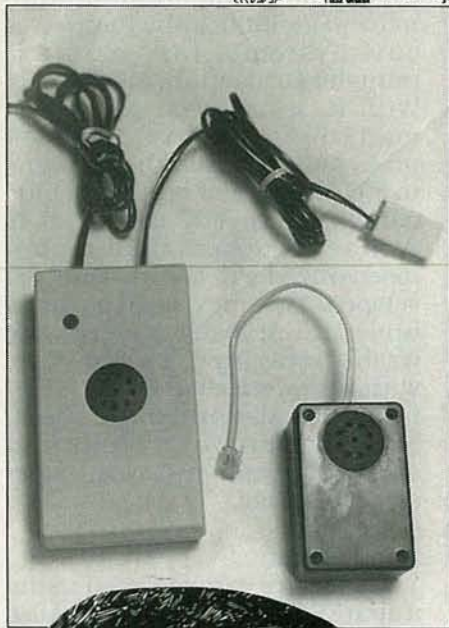
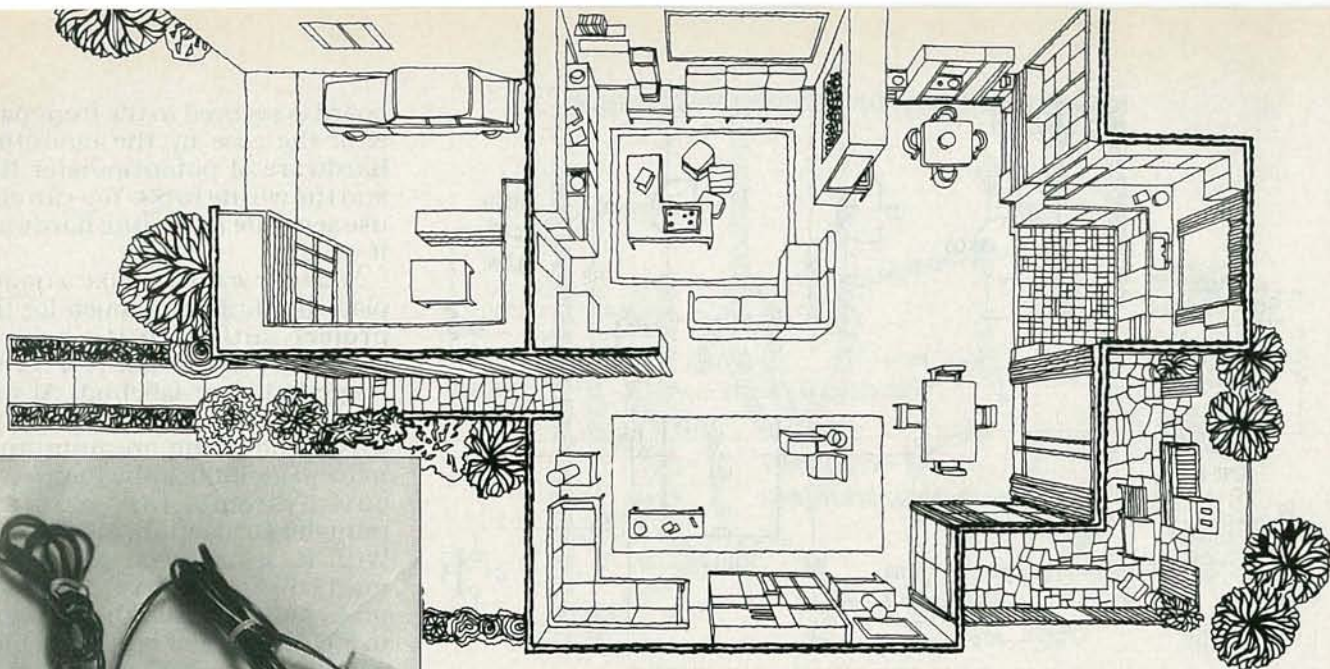

USE YOUR TELEPHONES AS A HOME INTERCOM SYSTEM



It's quick and easy to add an intercom feature to your existing home telephones.

FRANK POLIMENE

INTERCOMS HAVE BEEN AROUND FOR many years, providing a valuable tool in communications for home and industry. Unfortunately, these systems either require added hardware or hours of labor installing wires. Responding to demand, many manufacturers have incorporated the intercom as an added feature in their telephones. However, replacing your existing equipment is an expense that usually outweighs the justification.

The Phone-Com project we will describe may be used concurrently with any touch-tone phone system, and it provides features that make it practical, easy to use, and inexpensive. Because it connects to your existing

telephone equipment, there are no unsightly boxes to clutter up your desk.

How it works

To engage the intercom at any time, all you have to do is pick up any phone and press the "#" key. That causes one or more *alert modules* to sound an alarm, signalling other people in the home to pick up a phone. If you answer a call that comes in for someone else, pressing the "#" key will place the call on hold, and the alarm will sound on the alert modules signalling someone else in the home to pick up the phone. That someone else may then release the call on hold by pressing the "#" key or talk to you in pri-

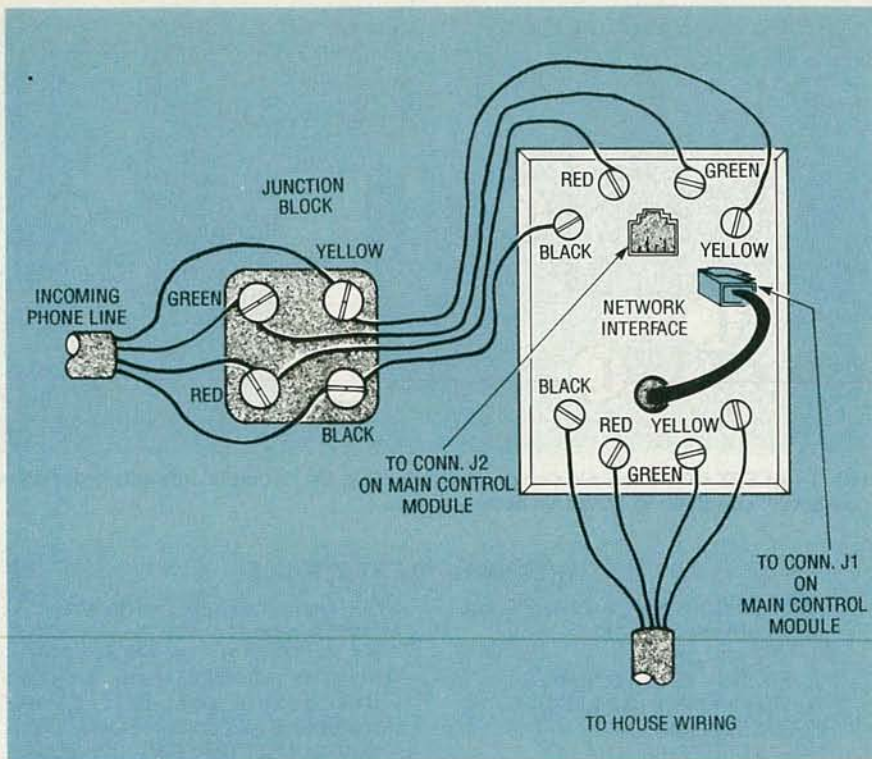

FIG. 1—THE PHONE-COM TAKES ADVANTAGE of a device called a "network interface," installed in most newer homes; it is simply a connector box that separates the outside phone line from your internal wiring.

vate before answering the call. Since the system is voice operated (VOX), the intercom will disengage and return to normal operation after approximately 30 seconds if no conversation is heard.

The Phone-Com takes advantage of a device called a "network interface," installed in most new homes over the past 10 years. Despite the complicated name, it is simply a connector box that separates the outside phone line from your internal wiring (see Fig. 1). Since a network interface is used by the phone company to determine whether problems are internal or external, a substantial premium service charge may be imposed if you don't have one. Therefore, it is highly recommended that one be installed, even if not for this project.

Theory of operation

Take a look at the schematic in Fig. 2. In the stand-by mode, relay RY1 is not energized and the only connection to the phone line is the coupling capacitor C1. The

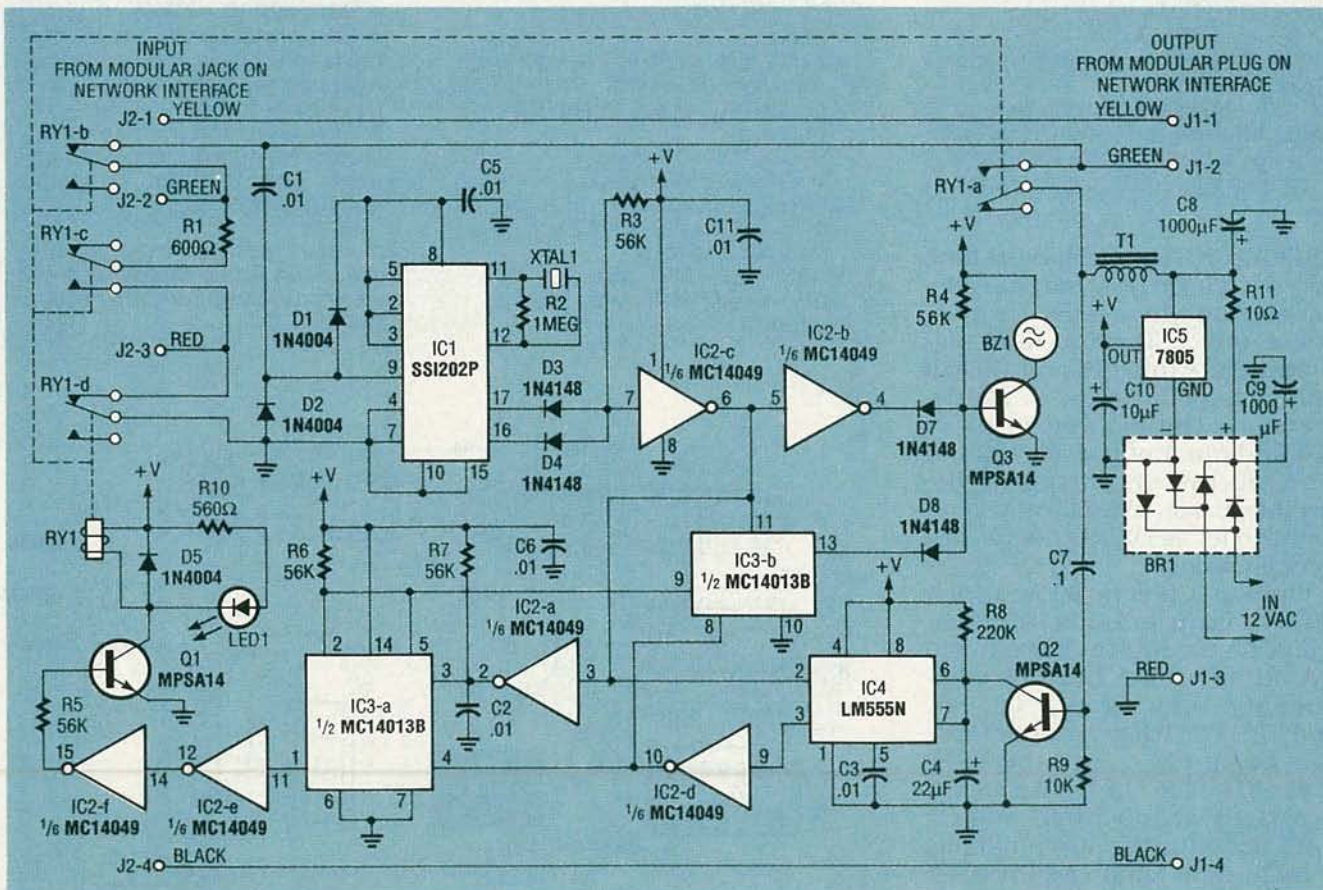

FIG. 2—CONTROLLER SCHEMATIC. The SSI202P is a telephone tone decoder whose BCD output is dependent on which tones are present at pin 9.

PARTS LIST—CONTROLLER

All resistors are ¼-watt, 5%, unless otherwise noted.

- R1—600 ohms, ½-watt
R2—1 megohm
R3—R7—56,000 ohms
R8—220,000 ohms
R9—10,000 ohms
R10—560 ohms
R11—10 ohms
Capacitors
C1—0.01 µF, 200 volts, ceramic disc
C2, C3, C5, C6, C11—0.01 µF, 50 volts, ceramic disc
C4—22 µF, 16 volts, tantalum
C7—0.1 µF, 50 volts, ceramic disc
C8, C9—1000 µF, 16 volts, electrolytic
C10—10 µF, 35 volts, electrolytic

Semiconductors

- IC1—SSI202P telephone tone decoder
IC2—MC14049 hex inverting buffer
IC3—MC14013B dual D-type flip-flop
IC4—LM555N timer
IC5—7805 5-volt regulator
Q1—Q3—MPSA14 or equivalent Darlington transistor
D3, D4, D7, D8—1N4148 diode
D1, D2, D5—1N4004 diode
LED1—red light-emitting diode
BR1—3N246 full-wave bridge rectifier
Other components
BZ1—100-dB Mallory Sonalert module
XTAL1—3.58-MHz crystal
RY1—DPDT mini relay, 1-amp contacts, 12-volt coil
T1—600/600 ohm audio isolation transformer
J1, J2—modular telephone jack
Miscellaneous: 12-VAC 500-mA plug-in transformer, PC board, project case, etc.

SSI202P (IC1) is a telephone tone decoder whose BCD output is dependent on which tones are present at pin 9. The two most-significant bits (pins 16 and 17) will only be high during a “#” key depression. The high on pin 7 of IC4 and pin 4 of IC2 allow Q3 to turn on, thereby energizing the audible alarm. The alarm will remain on for as long as the “#” key is depressed.

Pin 6 of IC2 is now low, which sends a clock pulse to IC3. That transfers the high at IC3 pin 2 to the output at pin 1, which energizes the relay through Q1, R5, and IC2. The trigger input of IC4, also being low, starts the VOX-timer IC4. The clock pulse to IC3 is delayed slightly by R7 and C2 until the output of IC4 pin 3 has enough time to remove the reset signal at IC3 pin 4. When the “#” key is released, pin 11 of IC3 goes high and toggles the output of

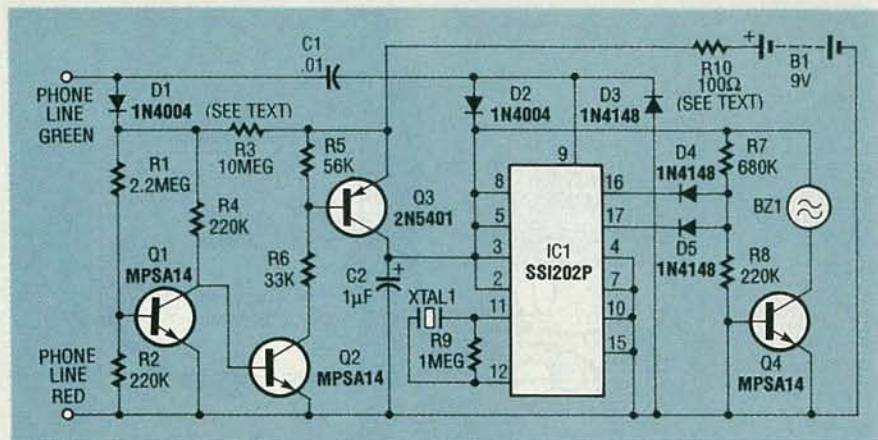

FIG. 3—ALERT MODULES plug into any phone jack; the circuit is only active during an “off hook” condition to conserve battery power.

PARTS LIST—ALERT MODULE

All resistors are ¼-watt, 5%, unless otherwise noted.

- R1—2.2 megohms
R2, R4, R8—220,000 ohms
R3—10 megohms (see text)
R5—56,000 ohms
R6—33,000 ohms
R7—680,000 ohms
R9—1 megohm
R10—100 ohms (see text)
Capacitors
C1—0.01 µF, 500 volts, ceramic disc
C2—1 µF, 16 volts, electrolytic
Semiconductors
IC1—SSI202P telephone tone decoder
Q1, Q2, Q4—MPSA14 or equivalent Darlington transistor
Q3—2N5401 or equivalent PNP transistor
D1—D3—1N4004 diode
D4, D5—1N4148 diode
Other components
B1—9-volt alkaline or 7.2-volt Ni-Cd battery (see text)
XTAL1—3.58 MHz crystal
BZ1—100-dB Mallory Sonalert module

- PL1—4-wire modular phone plug
Miscellaneous: 9-volt battery connector, PC board, project case, etc.
Note: The following items may be purchased from BCT Electronics, 8742 Belair Road, Baltimore, MD 21236 (301) 256-0344. MC/VISA, AX, and DISCOVER accepted. Add \$2.50 S&H for each total order.

- Drilled, etched, and screened controller PC board—\$7.95
- Drilled, etched, and screened alert module PC board—\$4.95
- SSI202P IC—\$11.95
- Complete controller kit (includes PC board and all components except phone jacks and housing)—\$39.95
- Complete alert module kit (includes PC board and all components except phone plug and housing)—\$24.95

Network Interfaces may be purchased at Radio Shack or most electronic suppliers for around \$5.00.

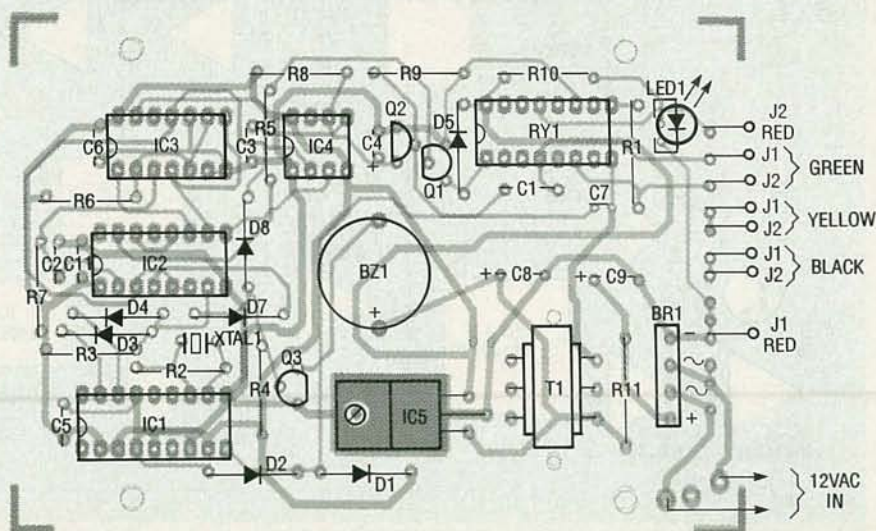

FIG. 4—PARTS-PLACEMENT DIAGRAM for the controller. It can be installed in any kind of case you can find.

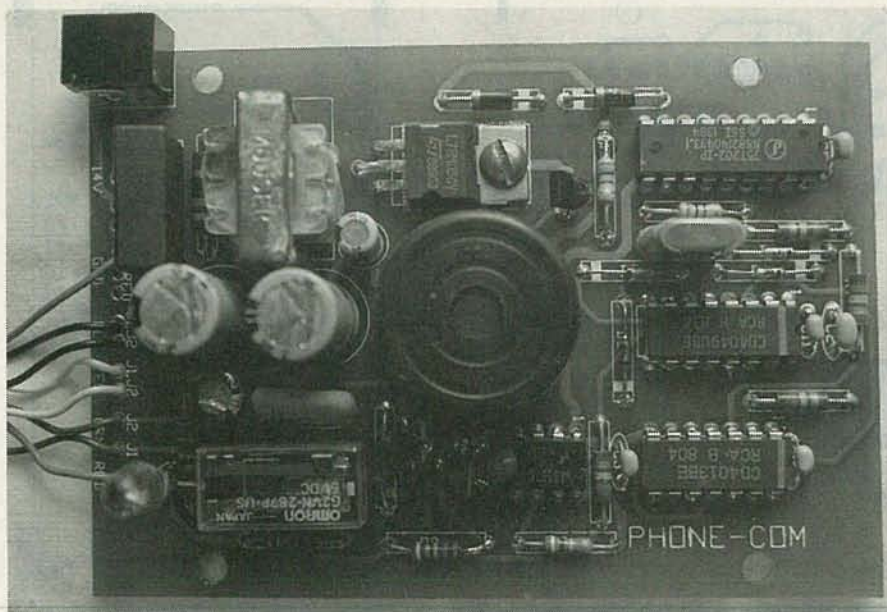

FIG. 5—THE FINISHED CONTROLLER BOARD is very neat and compact, so it doesn't take up much space.

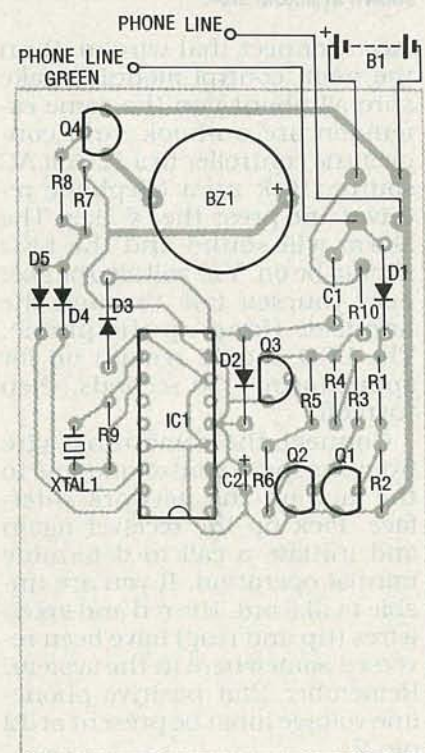

FIG. 6—PARTS-PLACEMENT DIAGRAM for the alert module. It's good to have at least one on every floor in your home, in a central location.

IC3 pin 13 to a low state, preventing the alarm to sound during the next depression of the “#” key (manual turn off).

If conversation continues, IC4 is prevented from time-out through C7 and Q2. If conversation stops for more than 30 seconds, C4 charges to the threshold voltage at IC4 pin 6 and

IC4 pin 3 returns to a low state. That places a high on the reset pin (pin 4) and the set pin (pin 8) of IC3, which turns off RY1, returning the system to the stand-by mode. Any calls in process are held by maintaining central-office loop current through R1 while in intercom mode.

Alert module

Alert modules plug into any phone jack (see Fig. 3), and can be powered by either a 7.2-volt rechargeable Ni-Cd or 9-volt al-

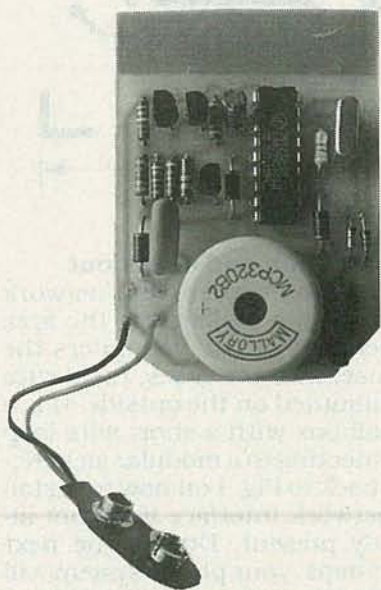

FIG. 7—A FINISHED ALERT MODULE. It can plug into any ordinary phone jack; use a T-connector if you must connect both a phone and an alert module to the same jack.

kaline battery. However, the circuit is only active during an “off hook” condition to conserve the battery. During normal operation, there is approximately 50 volts on the phone line. That allows base current to flow through R1 which turns on Q1 and holds Q2 in an off state preventing power to IC1 and the audible alarm. When the line voltage falls below 10 volts, as evident in an off-hook condition, Q2 turns on, thereby placing IC1 in the stand-by mode.

Telephone tones are decoded by IC1 as previously discussed. A “#” key activation will activate the alarm. Diode D1 is important in that it protects IC1 and the rest of the semiconductors from damage when the AC ringing voltage is present on the phone line. If you're using a rechargeable battery, charging current is supplied through R3 during on-hook conditions.

Construction

The Phone-Com controller is built on one PC board, and the alert modules are built on separate boards. Determine the number of alert modules you will need including the master control unit. The modules are loud enough to cover approximately 1000 square feet each, even when placed behind furniture. It is recommended that one module be installed in a central location on each floor of your house. Construction is straightforward, however, care should be taken when handling the static-sensitive decoder chips.

We have provided foil patterns for both boards, although the project can be built using point-to-point wiring. Double check your wiring before connecting the modules to the phone line if you don't use the boards. Figure 4 is a parts-placement diagram for the controller board. The finished board, shown in Fig. 5, can be installed in any kind of case you see fit.

The values for R3 and R10 depend on what type of battery you are using. Use 10 megohms for R3 and 82 ohms for R10 for a 9-volt alkaline battery. If a rechargeable battery is used, change the value of R3 to 82K and R10 to 10 ohms. Any audio

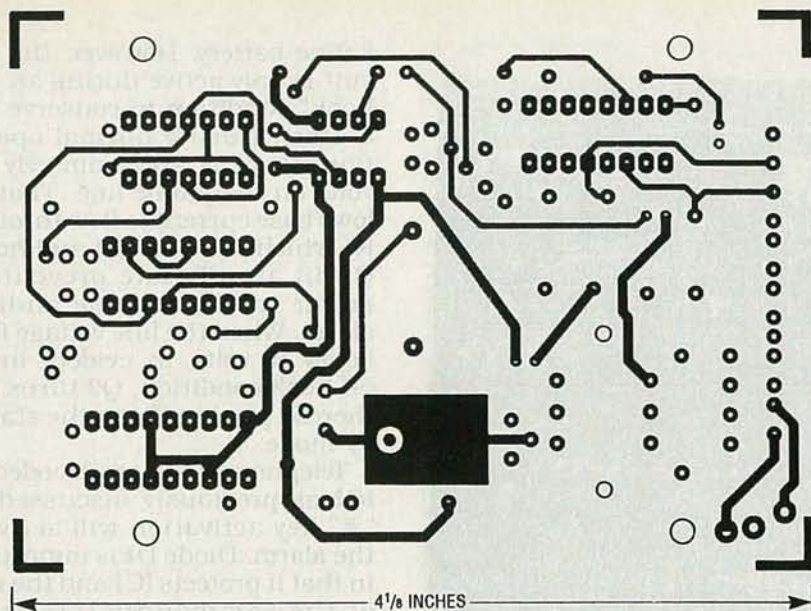

THE CONTROLLER BOARD is double-sided; here's the component side shown at actual size.

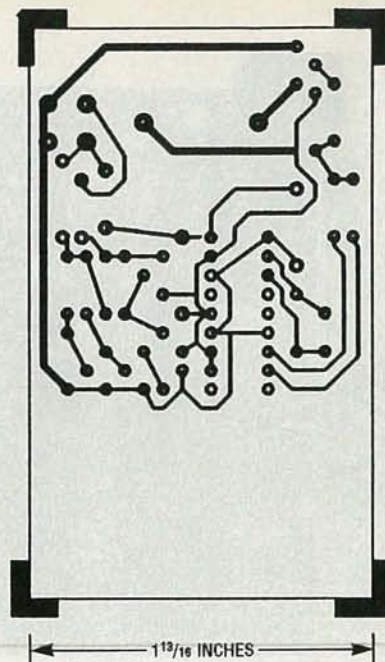

FOIL PATTERN for the alert module, also shown at actual size.

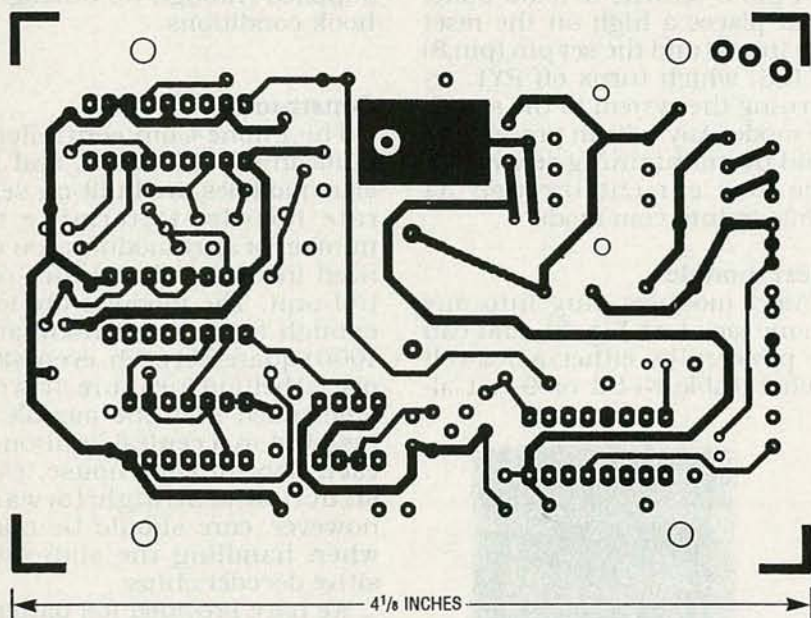

SOLDER SIDE of the controller board shown at actual size.

transformer with approximately a 500-ohm primary may be used for T1.

Figure 6 is a parts-placement diagram for the alert module, and Fig. 7 shows a finished unit. Again, the board can be installed in any case you like.

Follow the red/green color code shown in Figs. 2 and 3 when connecting the system to the phone line. A "T" adapter may be used if you need to connect additional equipment to the same jack. Velcro strips offer an easy way to secure the modules to a wall.

Installation and check out

Determine where your network interface is by locating the area where the phone line enters the house. In some cases, the device is mounted on the outside. It is a small box with a short wire loop connecting to a modular jack. Refer back to Fig. 1 on how to install a network interface if it's not already present. During the next few steps, your phone system will be inoperative until installation is complete.

Disconnect the short wire from the jack on the network inter-

face. Connect that wire to J1 on the main control module. Make sure all phones on the same extension are on-hook, and connect the controller to a 12-volt AC source. Pick up a telephone receiver and press the "#" key. The alarm will sound and the LED should be on. You will also be able to hear yourself talk through the handset. Hang up the phone. The LED should remain on for approximately 30 seconds, then turn off.

Connect the remaining wire from the main control module to the jack on the network interface. Pick up the receiver again and initiate a call to determine normal operation. If you are unable to dial out, the red and green wires (tip and ring) have been reversed somewhere in the system. Remember that positive phone-line voltage must be present at J2 pin 2.

It may be necessary to toggle the "#" key once or twice to get everything going when the system is first installed or after a power failure. Install the alert modules and determine the correct polarity by measuring a positive voltage at the anode of D1. Reverse the wires in the module if it turns out to be necessary. If a rechargeable battery is used, you should allow it to charge for at least 24 hours before activating the system.

R-E

IN OUR LAST EDITION, WE EXAMINED the basics of switching regulator power supplies. Now we'll dive into some real-world applications. We'll examine the 3524/5/7 and 3842 IC families in detail, summarize others, and show some typical circuits. In the process we'll study how to select components for those circuits and learn more about how switching regulator IC's are protected against such problems as startup current surges, under-voltage, and overload. We'll finish up with some basic troubleshooting hints.

Let's first start off with an explanation of the standard nomenclature used in naming the IC's we will discuss in this article. The first digit "1" indicates full military temperature range of -55 to 150°C, "2" indicates an industrial temperature range of -25 to 85°C, and "3" is a commercial temperature range of 0 to 70°C. Hereafter, we will refer only to the commercial version IC's, with prefix "3." Keep in mind that all those IC's are also available in military and industrial versions. A suffix of "A," "B," or "C" indicates an enhanced version of the IC, which we will discuss in more detail later in this article.

Manufacturers may use many different prefixes, some of which include

- SG—Signetics, SGS-Thomson, Motorola, and Linear Technology.
- CS—Cherry Semiconductor.
- XR—Exar.
- CA—GE-RCA.
- IC—IPS.
- LTSG—Linear Technology.
- LM—National Semiconductor.
- UC—Unitrode, Motorola, Linear Technology, and Signetics.
- UD—SGS-Thomson.
- IP—IPS.
- LAS—Lambda.

We'll take an in-depth look at two switching regulator IC families, with some applications, and guide you through basic troubleshooting techniques.

The SG3524/5/6/7 IC

Figure 1 shows the internal circuit of the switching regulator IC SG3524. In that circuit, the oscillator produces both ramp and pulse outputs. Ignoring the current limit (CL) and shutdown circuits for the moment, the comparator's output goes high when the ramp exceeds the output of the error amplifier. The NOR gates then go low, turning the output transistors off.

Each NOR gate can be high only when its three inputs are low. The oscillator output toggles the flip-flop, enabling one gate, and then the other to respond to the comparator. That action gates one transistor on at a time, providing push-pull operation. The selected transistor turns on at the start of each cycle, and turns off as soon as the ramp exceeds the error signal. At the end

of each cycle, the oscillator pulse momentarily forces both gates low, protecting against the possibility of both transistors being on at the same time.

The current-limit amplifier protects against current overloads. Its output is an open-collector type—open-circuit when high, pull-down to ground when low. The current-limit amplifier and the shutdown transistor can be used to force the comparator output high, shutting down both transistors.

Figure 2 shows the SG3524 in a simple DC-DC converter. The oscillator frequency of about 60 kHz is set by R5 and C2. (The flip-flop divides the push-pull output frequency to 30 kHz.) The current-limit amplifier goes low when its input exceeds 0.2 volts, limiting R11's current to 2 amps in case of overload or transformer

Inside SWITCHING POWER SUPPLIES

HARRY L. TRIETLEY



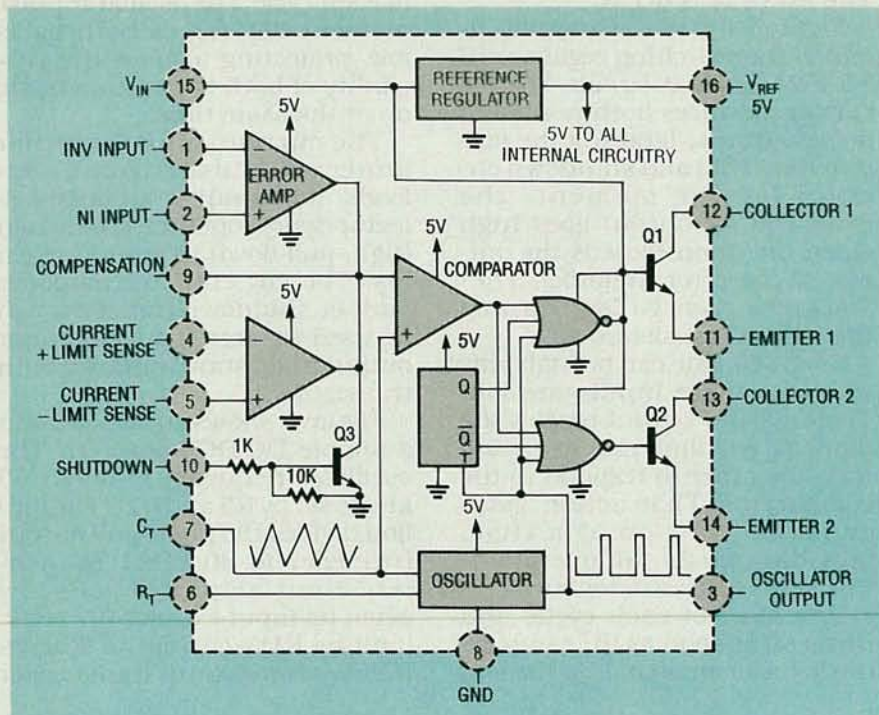

FIG. 1—INTERNAL BLOCK DIAGRAM of the SG3524 switching regulator IC.

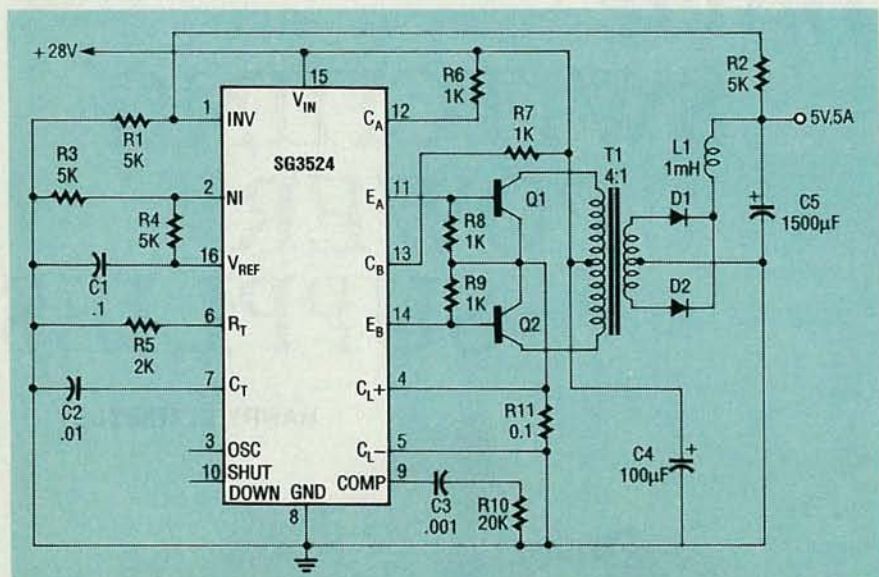

FIG. 2—THE SG3524, TWO SWITCHING transistors, a transformer and a few components create a complete 5-volt push-pull switching regulator.

saturation. Transistors Q1 and Q2 are used for switching transformer current. (The on-chip transistors are rated at only 100 mA.) Supply pulses produced by the circuit are filtered by C4.

The output of the error amplifier is proportional to the difference between the reference input (pin 2) and the feedback (pin 1). If the output increases, the error voltage drops. The ramp then reaches the error voltage more quickly and the transistors turn off sooner, until the output

is reduced back to 5 volts. Since the feedback voltage and ground are directly connected, input-to-output isolation is not provided.

Resistors R6 and R7 limit the current through the internal drive transistors, which are used to switch Q1 and Q2. Frequency compensation for closed-loop stability is provided by R10 and C3. Transistors Q1 and Q2 should be high-speed switching power transistors rated at least 5 amps and 60 volts. Schottky or fast-recovery diodes should be

used for D1 and D2. Because the output is balanced, the transformer core does not need to be gapped, a small ferrite core will do.

At high frequencies, the equivalent series resistance (ESR) of filter capacitor C5 is higher than its capacitive impedance. Low series-resistance electrolytics should be used, preferably capacitors designed specifically for switching supplies.

The enhanced SG3524A

Figure 3 shows the enhanced version SG3524A, which is pin-compatible and interchangeable with the non-A version. The enhanced version adds an under-voltage lockout circuit which disables the regulator until its input rises above 8 volts. That holds current drain to standby levels during turn-on, guarding against problems during startup, surges, and brownouts. A pulse-width modulator latch is also added, which eliminates multiple pulsing in noisy environments. Set by the comparator and reset by the clock pulse, it can switch only once per comparison cycle.

Further protection is provided by thermal protection circuitry (not shown). Performance specifications also are improved—the 5-volt reference is trimmed more closely ($\pm 1\%$) and the error amplifier's output can swing up to the 5-volt rail.

Let's look at one more member of this family, and an application. Figure 4 shows the workings of the SG3525A/7A. The 3525A and 3527A differ only in their output logic; the 3525A is low when off, while the 3527A is high when off. (The pinouts of the 3525A/7A do not match those of the 3524 IC series.)

Operation is similar to the 3524, but with added features. The oscillator has a sync input, making it easy to lock the frequencies of several supplies, eliminating problems with beat frequencies in multiple-supply boards or systems. The shutdown circuit (also included in the 3524A) and soft-start feature simplify the design of protective circuitry, as will be seen in the next application. The totem pole (push-pull) outputs, rated at maximum 500 mA, provide fast,

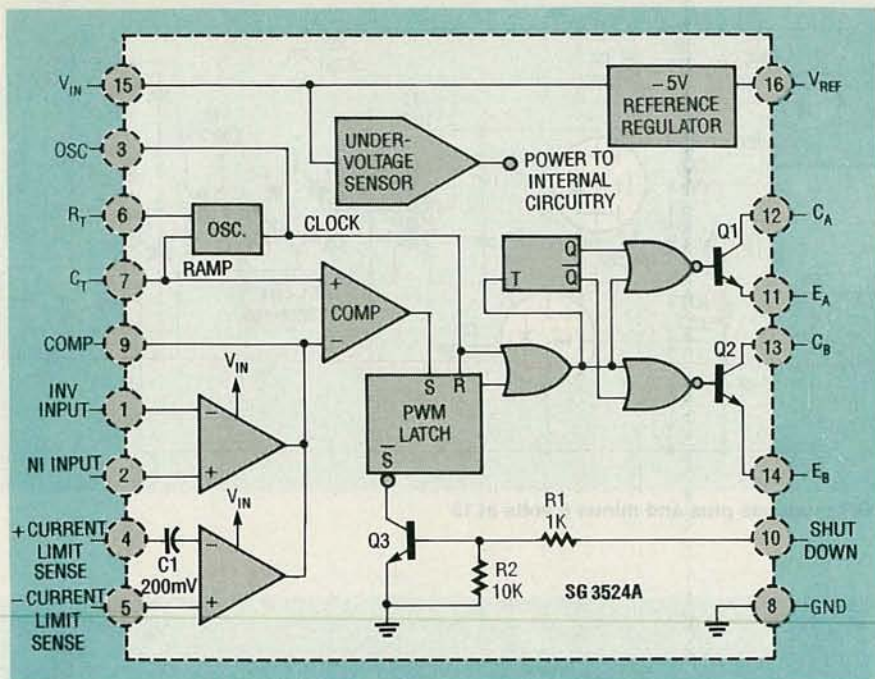

FIG. 3—THE SG3524A IMPROVES the basic device by adding undervoltage lockout, a pulse-width modulator (PWM) latch, thermal protection, and improved reference accuracy.

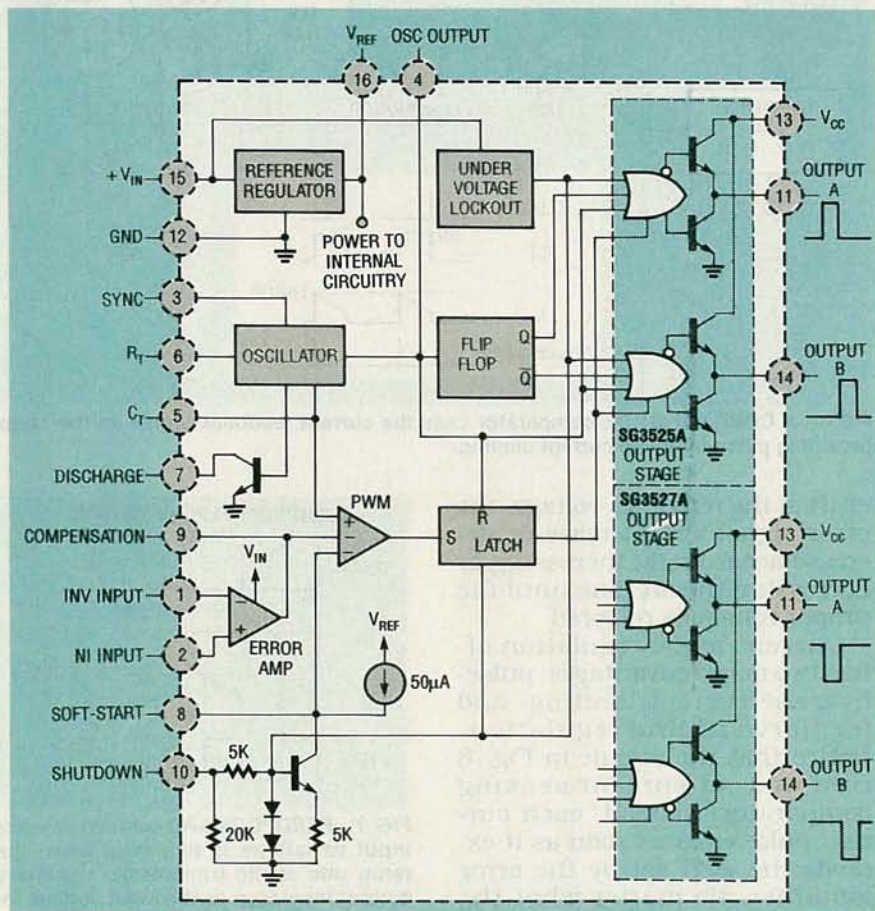

FIG. 4—THE SG3525A AND SG3527A PUSH-PULL switching regulators provide 500-mA, totem-pole outputs and oscillator synchronization.

solid switching for high and low transitions. The 3524's separate current-limit amplifier has been omitted.

Figure 5 shows a 15-watt DC-DC converter. The 200-kHz frequency (100 kHz final output) is set by R2-C2. The internal dis-

charge transistor (pin 7) allows control of the discharge time at the end of each ramp. That provides an ensured stoptime between output pulses so that, even with switching delays, both transistors cannot be on at once. A 47-nanosecond time constant is provided by R16-C2.

The 5-volt reference (pin 16) is connected to the noninverting input (pin 2) by current limiting resistor R3, while C9 provides high-frequency bypassing. Negative feedback voltage is divided by R1-R4, dividing the 6-volt output down to 5 volts. The basic theory of operation is similar to that of Fig. 2; the ramp is compared to the error signal to control the on-off switching of the outputs. On each cycle, the internal flip-flop selects either output A or B. The selected output is switched high at the start of each ramp and reset to low by the latch when the ramp voltage exceeds the error amp's output. As in Fig. 2, the direct feedback connection means there is no input to output isolation.

Compensation for closed-loop stability is provided by R6, R7 and C4. Switching spike currents are limited by R10, R11, and R12 in the output stages. Components C5 and R17 act as a "snubber," limiting switching transients from the primary.

When input power is first applied, Q1 will be off and soft-start capacitor C3 will be discharged. As C3 is charged from the internal 50-µA current source, its voltage will rise, gradually increasing the voltage to the pulse-width modulator (PWM) control's bottom input. That gradually increases the amount of time per cycle that the output is turned on, providing a "soft" rise of the output voltage, which allows the filter capacitors to charge slowly, reducing startup current surges.

If R9's current exceeds about 3 amps (0.7-volt drop), Q1 will turn on, energizing the shutdown circuit which pulls pin 8 low and discharges C3. As the current drops below 3 amps, Q1 turns off, C7 discharges, the shutdown input goes low and the soft-start capacitor provides a "soft" recovery for the power supply.

Power transformer T1 is wound on an EE25 ferrite core (0.25-inch center leg). It feeds a

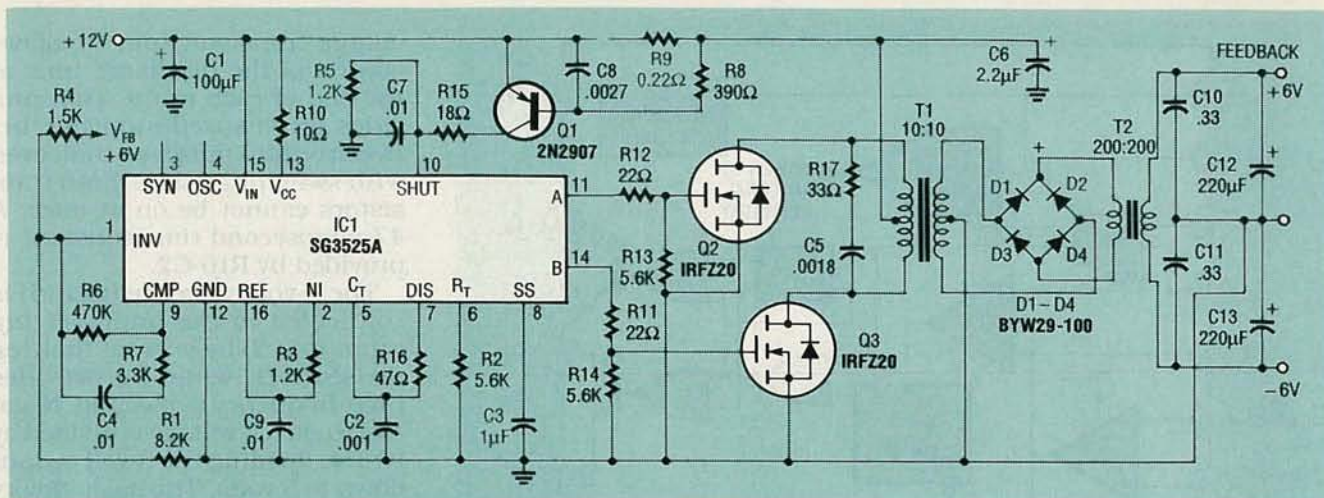

FIG. 5—A PUSH-PULL SWITCHING REGULATOR produces plus and minus 6 volts at 15 watts.

conventional full-wave bridge, providing + and - outputs. Coupled inductor T2, consisting of two coils wound on a cylindrical ferrite core, and the output capacitors filter the output to 50 millivolts peak-to-peak. Transistors Q2 and Q3 are 50-volt, 5-amp, N-channel power MOSFET's. Fast-recovery diodes must be used in the rectifier due to the high frequency; D1-D4 are 100-volt, 8-amp diodes with 35-nanosecond recovery.

Current-mode regulators

We now turn to a different class of switching regulators—current mode. Although the basic operating theory remains the same (pulse-width modulation), current-mode switching regulators differ in that the internal ramp is eliminated. In its place, the ramp-like increase in the transformer's inductive current is used for control.

Figure 6 shows the basics of a current-mode comparator. The pulse from an R-C clock sets the flip-flop, producing a high output. FET Q1 turns on and transformer current begins to flow. As the inductive current ramps upward, the feedback from current-sensing resistor R2 increases. Eventually, the feedback voltage equals the error amplifier's output, at which point the comparator resets the flip-flop, Q1 then turns off until the next clock pulse.

As with previous regulators, the feedback voltage, V_{FB} , represents the filtered output. If the feedback becomes lower or high-

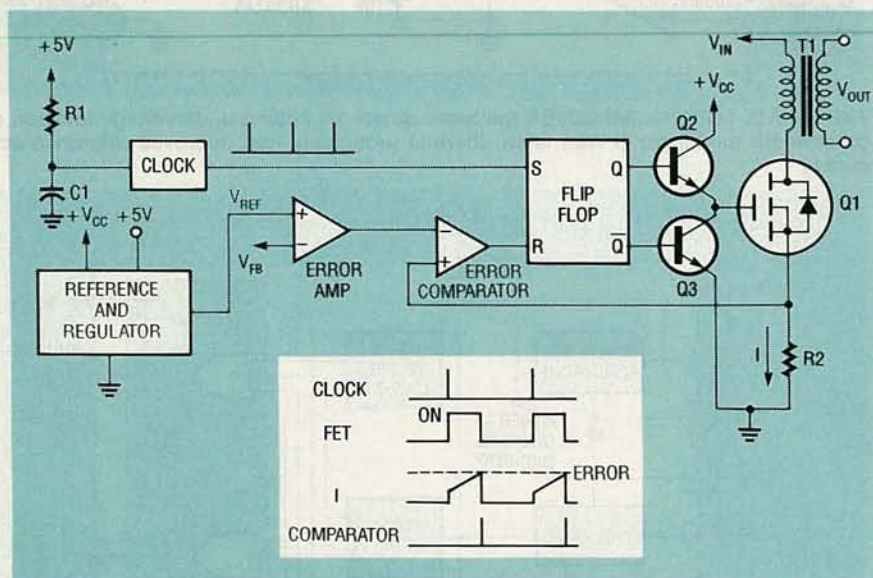

FIG. 6—A CURRENT-MODE comparator uses the current feedback signal as the ramp, providing pulse-by-pulse current limiting.

er than the reference voltage, the error signal will increase or decrease accordingly, increasing or decreasing the on time until the proper voltage is restored.

Current-mode regulation offers two major advantages; pulse-by-pulse current limiting, and feedforward line regulation. Notice that the circuit in Fig. 6 contains no current-sensing comparator. Instead, each current pulse ends as soon as it exceeds the level set by the error amplifier. No matter what the cause of overload, whether transformer saturation, an output short, or input overvoltage, the circuit will limit current instantly. Pulse-by-pulse limiting also eliminates the need for a separate soft-start circuit.

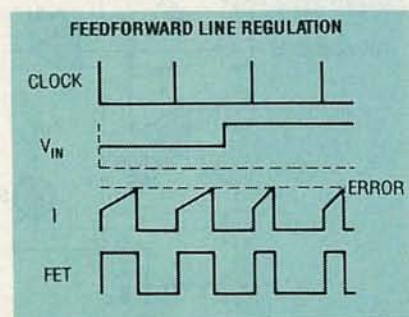

FIG. 7—FEEDFORWARD compensation of input variations is achieved when the ramp rate of the transformer's primary current increases as the input voltage increases.

Feedforward line regulation is illustrated by the waveforms shown in Fig. 7. With a fixed load, the input voltage suddenly increases. On the very next pulse,

the inductive current, I , ramps more quickly due to the increased transformer voltage. Since the feedback and the error signal have not changed, the limit is reached more quickly and the pulse width becomes shorter. Changes in line voltage are, therefore, compensated before they have a chance to affect the output.

UC3842/3/4/5

Figure 8 shows the block diagram of current-mode PWM controller IC UC3842. Compared with the circuit in Fig. 6, the UC3842 adds an undervoltage lockout and an output NOR gate. The undervoltage lockout, with hysteresis, disables the output pulses until V_{CC} rises above 16 volts. Once started, it will not drop out unless V_{CC} goes below 10 volts, a feature which prevents constant toggling between "operate" and "lockout." When disabled, the output (pin 6) goes to a high-impedance state. A "bleeder" resistor should be connected from pin 6 to ground to prevent leakage current from turning the switching FET on.

The output NOR gate implements lockout, but also serves another protective function. When the oscillator pulse is high, the NOR output will be low, the OR output high, and pin 6 low. The output cannot go high until the clock goes low. The clock is set up so that timing capacitor C_1 charges through R_1 , and discharges through the constant current sink. By choosing a larger capacitor and smaller resistor, the charging time (clock low) can be decreased and the discharge time (clock high) increased. That allows you to establish the maximum on time, or duty cycle, which is especially important in circuits where duty cycles higher than 50% can lead to transformer core saturation.

The D2-D4-R1-R2 network between the error amplifier and the current-sensing comparator reduces the error signal so that excessive power is not lost in the current-sensing resistor. The one-volt Zener diode clamps the error signal so the maximum turn-off level will never exceed one volt.

UC3843 is similar to the 3842 but has a lower lockout voltage.

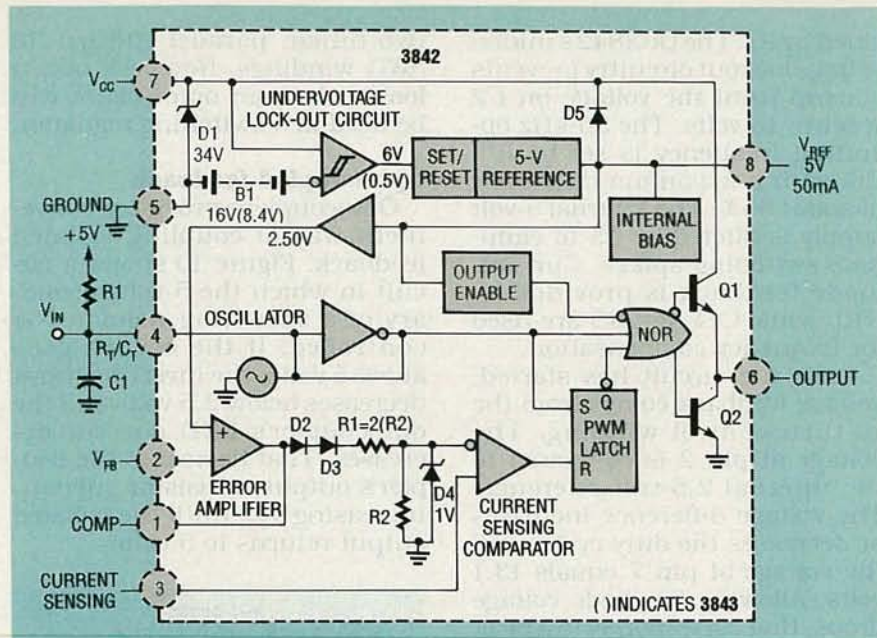

FIG. 8—INTERNAL BLOCK diagram of the UC3842 current-mode switching regulator IC. The UC3843 IC is similar but operates with a lower undervoltage lockout.

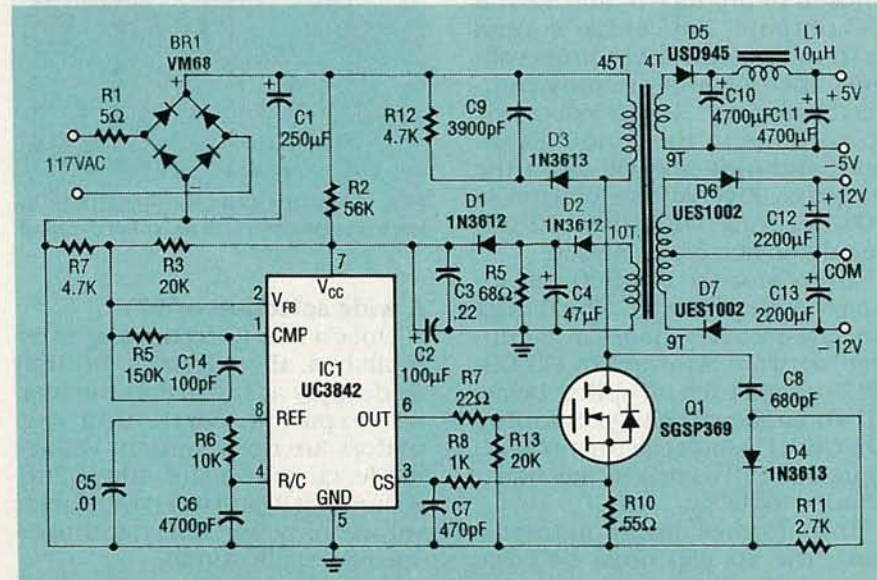

FIG. 9—THIS OFF-LINE CURRENT-MODE regulator produces isolated +5 volts and ±12 volts from 117-volt line power.

Intended for use at lower voltages, it operates at 8.4 volts, and drops out at 7.9 volts. UC3844 and UC3845 (not shown) have one added feature; a flip-flop which disables the output on alternate clock cycles. That guarantees the duty cycle will always be less than 50% for circuits where that is critical.

An off-line flyback converter

Figure 9 shows an SGS-Thomson UC3842 IC in an "off-line" flyback regulator. The circuit provides +5 volts at 4 amps and ±12 volts at 300 mA, and can deliver

27 watts.

The term "off-line" means that the regulator is on the primary side of the transformer and operates directly "off the line." The primary advantage of such a circuit is that large amounts of power can be coupled through a small, high-frequency transformer. Line operation requires high-voltage transistors and diodes, and prevents direct coupling between the output and the feedback circuit.

The line voltage is rectified and filtered by BR1 and C1. Initial startup current to the IC is pro-

vided by R1. The UC3842's under-voltage lockout circuitry prevents startup until the voltage on C2 reaches 16 volts. The 50-kHz operating frequency is set by R6-C6, with a maximum duty cycle of about 95%. The internal 5-volt supply is filtered by C5 to eliminate switching spikes. Current-mode feedback is provided by R10, while C14 and R5 are used for frequency compensation.

Once the circuit has started, voltage feedback comes from the 10-turn control winding. The voltage at pin 2 is compared to the internal 2.5-volt reference. The voltage difference increases or decreases the duty cycle until the voltage at pin 7 equals 13.1 volts. Allowing for diode voltage drops, that corresponds to a peak voltage of about 14.6 volts on the control winding. The control-to-secondary turns ratios are chosen to produce 5- and 12-volt DC outputs. Notice that control is from the control winding's voltage, the outputs are only indirectly regulated. Power losses due to currents in the windings, diodes and inductor will affect the outputs. Five-volt regulation is 10% accurate, while the ± 12 -volt regulator has 5% accuracy.

Transistor Q1 is a 500-volt, 5-amp power MOSFET. The diodes are fast-recovery diodes. A "snubber" network is formed by D3-C9-R12 to hold turn-off spikes below Q1's breakdown voltage. Snubber D4-C8-R11 slows the turn-off rise time until Q1's current has had a chance to decay.

Transformer design is important; the air gap must be large enough to prevent core saturation but small enough to maintain the required inductance. (Note that an air gap is not needed in balanced push-pull circuits.) In the Fig. 9 circuit, an EC35 ferrite core is used ($\frac{3}{8}$ -inch dia. center leg, Ferroxcube EC35-3C8) with a 0.5 mm gap in the center leg.

The primary winding consists of 45 turns of 26 AWG wire. The 12-volt windings are each 9 turns of 30 AWG wire, wound together (bifilar). The 5-volt secondary is only 4 turns, but instead of using a heavier gauge wire, four bifilar, 4-turn windings of 26 AWG wire are used, with their ends connected in parallel. The control (feedback) winding consists of

two bifilar, parallel 10-turn 30 AWG windings. Now let's take a look at how an optoisolator can be used in a switching regulator.

Optocoupled feedback

Optocouplers provide a convenient way of coupling isolated feedback. Figure 10 shows a circuit in which the 5-volt secondary of a switching regulator is controlled. If the output goes above 5 volts, the inverting input decreases below 2.5 volts and the optocoupler's LED current decreases. That decreases the coupler's output transistor current, increasing V_{FB} until the isolated output returns to 5 volts.

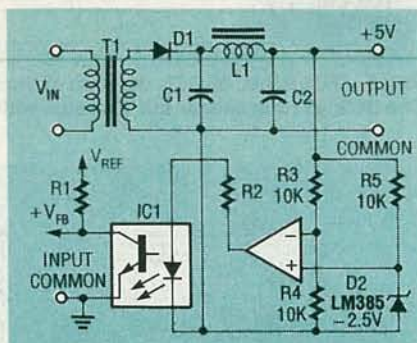

FIG. 10—OPTOCOUPLED FEEDBACK allows precise control of an isolated output.

A wide selection of IC's

Once a new IC technology is established, the offerings multiply as designs advance and the market expands. Switching regulators are no exception. Voltage mode, current mode, single-ended and push-pull IC's cover a wide variety of power levels and user-specific applications.

Table 1 summarizes some of the many IC families available. Most of the devices shown can be multiple-sourced. The part number prefixes vary from manufacturer to manufacturer, and many offer additional, proprietary devices.

It's not possible to fully describe all devices in an abbreviated table, but the listing should help direct you to data sheets for IC's to meet your needs. The 8-pin devices tend to be simpler to apply, while the 16-pin and larger IC's generally offer more complicated protective and "housekeeping" features.

The 3524/5/7 and 3842-7 families have been fully covered in this article. The 4191-3 family,

with its low operating voltage and 200- μ A current drain, is ideal for battery and micropower applications. Companion micropower device 4391 provides regulated negative outputs from positive supplies. LT1070 is the only IC in the listing housed in a power IC package.

Troubleshooting hints

When troubleshooting switching regulators, always begin with the obvious. Check for input power and output shorts, broken wires, defective connectors, solder bridges, defective solder joints, bad copper traces, scorched components, and so on. It's surprising how often a good visual inspection can uncover a problem.

Make sure you have a data sheet, pinouts of the control IC, and a circuit schematic, preferably with voltages and waveforms. There is such a wide variety of IC's and operating modes that it's difficult to troubleshoot on an intuitive basis. Figure 11 shows a "generic" block diagram, which may help you to think through the circuit function-by-function.

When breadboarding temporary components, remember that switching regulators produce fast, high-current pulses. Conductor size and lead dress are important. The input filter capacitor should be close to the IC, not a foot away. If the main source of power is at a distance, add a several hundred microfarad input bypass capacitor next to the IC.

Even though you may understand the operation of switching regulators, troubleshooting them can be difficult. The IC and its circuitry perform many functions, and the failure of one can cause improper operation of the rest. For example, failure of the feedback circuit may lead to over-voltage, overcurrent, and shutdown by one of the protective features. Is the circuit dead, unstable or out of regulation? That alone may often narrow the search to one particular part of the circuit.

The following hints may help you pinpoint the problem to a specific area of the circuit. After the visual inspection, check the output for shorts or overloads and check the input source, rectifier, filter, and transformer.

TABLE 1—A SUMMARY OF SELECTED SWITCHING REGULATOR IC'S

IC Family	Manufacturers*	Mode V or I	Output (Single or Push-Pull)	Package	Supply	I _{OUT} Max	Reference	Comments
3524/5/7	CS, ERIC, EXAR, GE, IPS, LT, MOT, NAT, SGS, SIL, SLG, TI, UNI	V	P-P	16 Pin	8-35V	100mA	5 or 5.1V	See Article.
3842-7	CS, ERIC, IPS, LT, MOT, SGS, SIG, TI, UNI	I	S	8 Pin	8 (or 16)-25V	1A	5V	See Article.
4191-3	MAX, RAY	V	S	8 Pin	2.4-30V	150mA	1.31V	Micropower for battery applications, 200 μ A quiescent supply current.
4391	MAX, RAY	V	S	8 Pin	-4 to -30V	100mA	1.25V	Inverting, micropower for battery applications, 250 μ A supply at 4V.
5560 5562	CS, IPS, SIG	V	S	16 Pin 20 Pin	10.5-18V 10-16V	40mA 100mA	3.72V 3.80V	Full-featured, flexible.
5561		V	S	8 Pin	10.5V-18V	20mA	3.75V	Lower cost, fewer housekeeping functions.
493/4/5 593/4/5	CS, EXAR, GS, IPS, MOT, NAT, TI, UNI	V	P-P	16 or 18 Pin	7-40V	200mA	5V	
μ A78S40	MOT, NAT	V	S	16 Pin	2.5-40V	1.5V	1.24V	Universal subsystem IC.
125/7	IPS, SIL	V	P-P	16 Pin	8-35V	100mA	5.1V	
33060/ 34060/ 35060	IPS, MOT	V	S	14 Pin	7-40V	500mA	5V	
1060	IPS, PLES	V	S	16 Pin	20mA into 5V shunt regulator	40mA	3.7V	
LT1070	LT	I	S	5 Pin Power	3-40V	5A	1.24V	Self-contained power IC.

*Manufacturers: CS=Cherry Semiconductor, ERIC=Ericsson, EXAR=Exar, GE=GE/RCA/Harris, GS=Gold Star, IPS=Integrated Power Semiconductor, LT=Linear Technology, MAX=Maxim, MOT=Motorola, NAT=National Semiconductor, RAY=Raytheon, SGS=SGS-Thomson, SIG=Signetics, SIL=Siliconix, SLG=Silicon General, TI=Texas Instruments, UNI=Unitrode

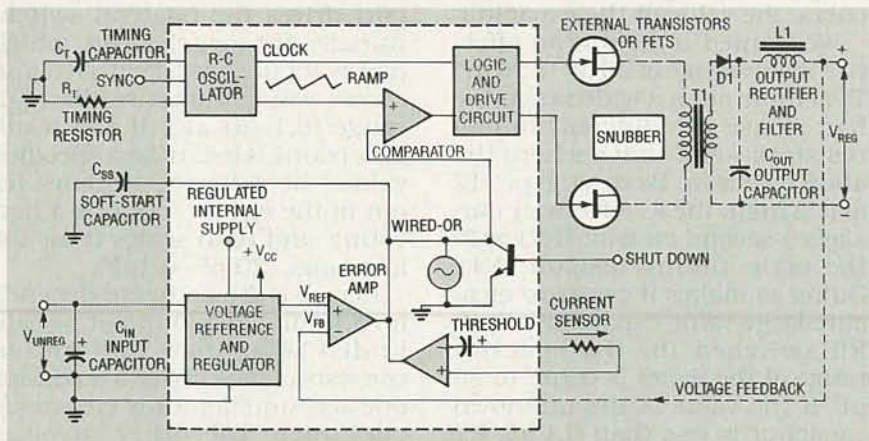

FIG. 11—THIS "GENERIC" BLOCK DIAGRAM of a switching regulator is useful in sorting out the functions which make up the circuit.

Sometimes a failure which looks like it might have been caused by output overload is actually caused by a low input voltage. When the input voltage drops, the regulator's duty cycle increases, raising the input current. The increased current may further drag down the voltage, resulting in even higher current drain, until an input fuse or circuit breaker trips or something burns out.

If the output is dead, check the rectifier and filter, the drive transistors and the output transformer or inductor. Before replacing damaged components check any snubber or surge-suppress-

Schools and colleges teach many things—but they don't teach electronic-equipment manufacturing. Most of us pick up that type of knowledge through on-the-job experience or through our hobbies. (In fact, hobby magazines like **Radio-Electronics** probably are the most common teachers of practical design and construction.) However, many engineers graduate from school and enter the work force with little or no practical experience.

Recently I had to set up a training center to instruct young engineers at my company in basic manufacturing processes. My task was to create a small manufacturing factory where students would build an electronic product. In the process, they would experience every stage of the manufacturing process: interpreting engineering drawings, buying parts, testing them, building the product, and shipping it to the customer. The project was dubbed the Manufacturing Technology Facility (MTF).

With a limited budget and limited time in which to teach more than 400 people, I searched for automation aids that would speed up the mundane work without attenuating the manufacturing experience we were trying to impart. One area I attacked was incoming inspection. In a normal manufacturing plant, parts are bought from many sources. When they arrive, they are tested to ensure they work, because it can cost more than \$10 to find and fix a bad \$1 part in a finished product.

The product we built had more than thirty different types of electronic parts, which fell into five groups: resistors, capacitors, diodes, transistors, and ICs. What I needed was a low-cost way for students to inspect the parts quickly, but with minimum chance for error. The result was what we now call the Component Inspection System (CIS). It incorporates a capacitance meter, an IC tester, and a computer-controlled voltmeter used for testing resistors and diode and transistor junctions. The CIS software includes a database containing each component's specifications, complete with pass/fail criteria. In addition, the system

contains a data-logging function that allows us to maintain a record of each vendor's quality history, which is useful in selecting vendors.

In future articles, we will describe different components of the CIS hardware and software. This time we'll present a \$15 two-IC circuit that lets you use your PC as a capacitance meter. Later installments will include complete details for building sophisticated component and IC testers. When space is available, we'll provide the software listings (all of which are in QuickBASIC); compiled programs and source code are also available.

PC-based capacitance meter

The first project is a capacitance meter. It will be incorporated into the next project, a combined voltmeter, ohmmeter, and capacitance meter on a PC board, but it can also be used as a stand-alone test instrument. First let's discuss the details of hardware operation.

The circuit, shown in Fig. 1, consists of two ICs: a 555 timer (IC1) and a quad bilateral switch (IC2). The 555 is the heart of the circuit. When configured in the astable (one-shot) mode, the length of the pulse generated at pin 3 is directly proportional to the value of the timing resistor (R1) and the timing capacitor (C_x). With a fixed timing resistor, the duration of the output pulse will be directly proportional to the value of the timing capacitor. Thus, by connecting a known resistor and an unknown capacitor to IC1, triggering it, and then measuring the length of the resultant output pulse, we can calculate the value of the capacitor.

We wanted to obtain an effective meter range of 20 pF to 20 μF. To achieve such a wide range, we had to use two different timing resistors—and that's where the 4066 comes in. By driving pin 12 of IC2 high, the IC effectively parallels a second resistor (R2) with the main timing resistor (R1). Doing so makes it easier to measure large-value capacitors. With R2 switched in, the effective range of the meter is 0.1 μF to 20 μF. If the value of the unknown capacitor is less than 0.1 μF, R2 can be switched out of the circuit (automatically by the software)

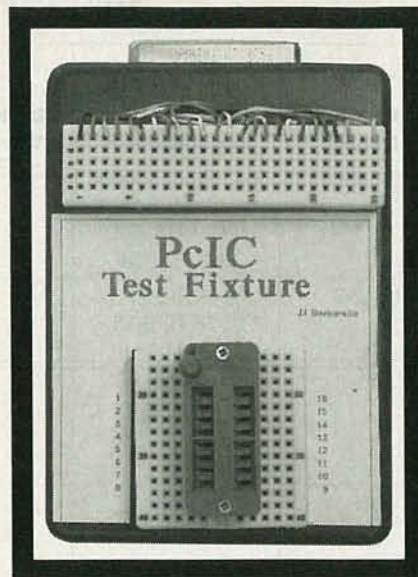

and the capacitor can then be re-measured.

The PC connection

The capacitance meter attaches to your PC via three lines (plus ground) of a standard parallel port. The **AUTOFD** signal connects to IC1's **TRIGGER** input (pin 2) to initiate the timing cycle. The **ACK** line from the port connects to IC1's output (pin 3). In operation, our software drives **AUTOFD** momentarily low and then high again to trigger IC1. While the PC counts the time interval, the capacitor charges until IC1's internal comparator drives its output from low to high. At that time, **ACK** senses the end of the timing cycle and alerts the PC to stop counting. The software then converts the elapsed time interval to a capacitance value.

The D6 line from the parallel port drives the bilateral switch. Initially, the switch is on, which places R2 in parallel with R1, and allows you to measure the high range (0.1–20 μF). If the resultant count is less than a specified value, the software switches R2 out of the circuit, obtains a new count, and then scales it for the low range (20 pF–0.1 μF).

Because the software depends on a timing loop, it must be calibrated before use. Calibration consists of making two readings: one accounts for stray circuit capacitance; the other involves measuring a known capacitor to provide a standard. The circuit

EXPERIMENTING WITH PC-BASED TEST EQUIPMENT

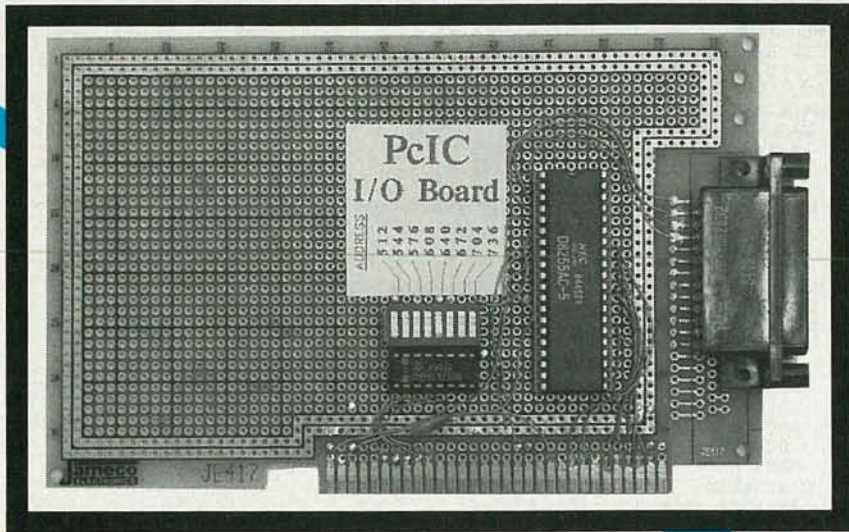

must be recalibrated if the PC's operating speed changes (e.g., via a turbo mode), or if you connect the meter to another PC.

Software

The simplicity of the hardware is made possible by the software. Although we won't discuss all the details here, there are a few points you should be aware of in the event you wish to modify the software. First, there are two programs, CAP and CAPFAX; CAP is the main program and CAPFAX helps calibrate the software. Both programs are written in Microsoft's QuickBASIC. The software must be compiled; interpreters (including BASICA and GWBASIC) do not run quickly enough to measure capacitors less than $1 \mu\text{F}$. If you want to use the software as is, you don't need to own a copy of QuickBASIC; a compiled version is available from the author, as mentioned in the parts list. However, to modify the software, you will need a copy of QuickBASIC.

Now let's talk about CAP. Before doing anything else, the software locates the I/O address of your

parallel printer port. That is necessary because some cards don't address their printer ports at the standard location (0378h or 888 decimal). In Listing 1, line 16 locates the address and stores it in variable C. (Note that line numbers are optional in QuickBASIC; they are shown here for reference only.) Variables B and A, which are derived from C, are used to read IC1's output and to operate IC2, respectively.

The measuring function begins in line 18, which switches in the 100K resistor. The next line initializes the counting variable, X. The next line contains two functions. The first, consisting of the OUT statements, generates a negative-going pulse to trigger IC1. The WHILE/WEND loop then continually increments X until pin 3 of IC1 goes low.

The remainder of the program determines if R2 should be switched in, converts the count to a capacitance value, and displays the value in an appropriate form (pF or μF).

**Build your own
low-cost PC-based
test equipment**

JAMES J. BARBARELLO

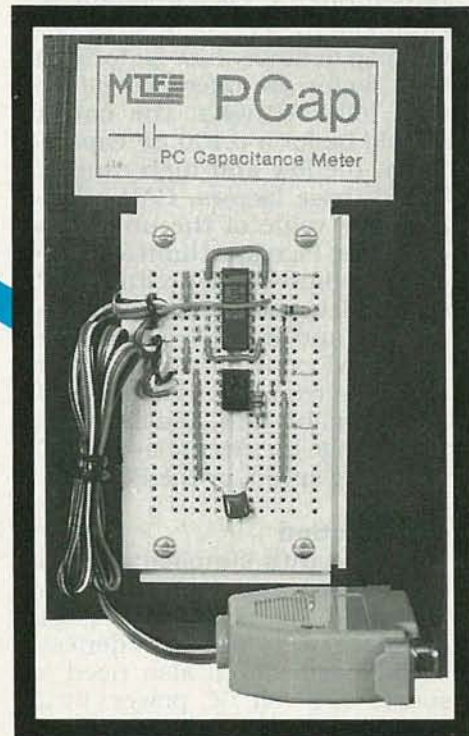

You use the second program, CAPFAX, to create a data file (CAPFAX.DAT) that contains information required by CAP. (CAPFAX is shown in Listing 2.) Five values are required: zero offset, low factor, high factor, picofarad limit, and microfarad limit. Zero offset is the count obtained with no capacitor connected to the circuit. In operation, CAP subtracts this value from the count ob-

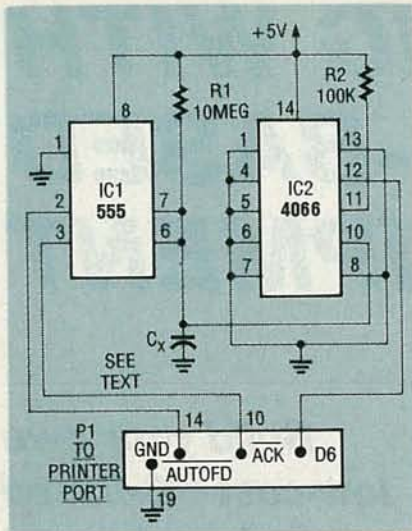

FIG. 1—SCHEMATIC DIAGRAM. The capacitance meter consists of two IC's: a 555 running in the astable mode, and an analog switch that allows the software to perform automatic range switching.

tained during measurement to eliminate the effects of stray circuit capacitance. Low factor and high factor are reference values that tell CAP what the count should be for a 0.100 μF capacitor in the low and high ranges. Using those factors, CAP calculates the value of the unknown capacitor. Picofarad limit and microfarad limit are values that CAP uses to determine when to switch ranges, and how to format the measured value for presentation on the screen. CAPFAX is used during calibration, and any time you change the circuit layout, PC operating speed, or the PC itself.

Construction

The circuit's simplicity allows just about any construction method to be used. The easiest approach is to use a solderless breadboard. You'll also need a source of 5-volt DC power; in a pinch you could power the circuit with three batteries in series (the 4.5 volts produced should be adequate to generate the required TTL logic levels.) If you use a CMOS 555, the batteries will last a long time.

As shown in Fig. 1, several pins of IC2 must be grounded to ensure proper switching operation. If those pins are not grounded, the meter may operate erratically.

To connect the unknown capacitor, you could insert it directly into the solderless breadboard. For more convenient

access, you could use a pair of binding posts connected via short lengths of wire. Although doing so adds stray capacitance to the circuit, it can be canceled during calibration.

After building the circuit, wire a short cable from a standard DB-25 male connector and four

lengths of wire. Connect the appropriate pins on the connector to the circuit, and the DB-25 end to your PC's parallel port.

Calibration

Calibration must be performed prior to using the meter. To perform the calibration, you need a

LISTING 1

```

1  REM*****
2  REM**   CAP.BAS   *
3  REM**   V900114   *
4  REM*****
5  REM
6  REM** NOTE: THIS PROGRAM MUST BE COMPILED WITH QUICKBASIC 4.0 PRIOR TO
7  USE
8  REM
9  DEF SEG = 64: DEFINT A-C, I, K: DEFLEN X
10 OPEN "r", 1, "capfax.dat", 50
11 FIELD 1, 10 AS ol$, 10 AS fl$, 10 AS fh$, 10 AS pf$, 10 AS uf$
12 GET 1, 1
13 offsetlo = VAL(ol$): FACTORLO! = VAL(fl$): FACTORHI! = VAL(fh$)
14 apf = VAL(pf$): auf = VAL(uf$)
15 CLOSE
16 FACTORLOPF# = FACTORLO! / 1000000: factorhipf# = FACTORHI! / 1000000
17 GOSUB S1: C = PEEK(8) + 256 * (PEEK(9)) + 2: B = C - 1: A = B - 1
18 RESTART:
19 OUT A, 64
20 X = 0: LOCATE 12, 31: PRINT " MEASURING... ";
21 OUT C, 2: OUT C, 0: WHILE (INP(B) AND 64): X = X + 1: WEND
22 SELECT CASE X
23 CASE IS > auf
24   measuredvalue = X / FACTORHI!
25   LOCATE 12, 31: PRINT SPACES(18);
26   LOCATE 24, 1: PRINT "Hi - uf";
27   LOCATE 12, 36: PRINT USING "####.# uf"; measuredvalue
28   GOTO SKIPIT
29 CASE ELSE
30   OUT A, 0
31 END SELECT
32 OUT C, 2: X = 0: OUT C, 0: WHILE (INP(B) AND 64): X = X + 1: WEND
33 SELECT CASE X
34 CASE IS > apf
35   measuredvalue = (X - offsetlo) / FACTORLO!
36   measuredvalue = INT(measuredvalue * 10000) / 10000
37   LOCATE 12, 31: PRINT SPACES(18);
38   LOCATE 24, 1: PRINT "Lo - uf";
39   LOCATE 12, 36: PRINT USING "#.### uf"; measuredvalue
40   GOTO SKIPIT
41 CASE ELSE
42   AA = 0: XX = 0
43 REDO:
44   OUT C, 2: X = 0: OUT C, 0: WHILE (INP(B) AND 64): X = X + 1: WEND
45   IF AA < 5 THEN AA = AA + 1: XX = X + XX: FOR i = 1 TO 100: NEXT i:
46   GOTO REDO
47   mean = XX / 5: X = mean
48   LOCATE 12, 31: PRINT SPACES(18);
49   measuredvalue = (X - offsetlo) / FACTORLOPF#
50   LOCATE 24, 1: PRINT "Lo - pf";
51   LOCATE 12, 36: PRINT USING "#### pf"; measuredvalue
52 END SELECT
53 SKIPIT:
54 LOCATE 24, 62: PRINT SPACES(17); : LOCATE 24, 62: PRINT "Count: "; X;
55 COLOR 7, 0: LOCATE 20, 29
56 COLOR 0, 7: PRINT " M "; : COLOR 7, 0: PRINT "easure, or ";
57 COLOR 0, 7: PRINT " E "; : COLOR 7, 0: PRINT "nd ... ";
58 Tryagain:
59 Reply$ = UCASE$(INPUT$(1))
60 SELECT CASE Reply$
61 CASE "M"
62   LOCATE 12, 37: PRINT SPACES(6)
63   GOTO RESTART
64 CASE "E"
65   CLOSE : END
66 CASE ELSE
67   BEEP: GOTO Tryagain
68 END SELECT
69 END
70 S1:
71 CLS : LOCATE 3, 23: COLOR 0, 7: PRINT SPACES(35)
72 LOCATE 4, 23: PRINT " PC CAPACITANCE METER "
73 LOCATE 5, 23: PRINT " (c) 1990, JJ BARBARELLO "
74 LOCATE 6, 23: PRINT SPACES(35): COLOR 7, 0
75 LOCATE 11, 30: PRINT CHR$(222); STRING$(19, 223); CHR$(221)
76 LOCATE 12, 30: PRINT CHR$(222); LOCATE 12, 50: PRINT CHR$(221)
77 LOCATE 13, 30: PRINT CHR$(222); STRING$(19, 220); CHR$(221)
78 RETURN

```

LISTING 2

```

1 REM** CAPFAX.BAS
2 REM** REVISE CAPFAX.DAT ENTRIES
3 REM** V900114
4 CLS : OPEN "r", 1, "capfax.dat", 50
5 FIELD 1, 10 AS zero$, 10 AS low$, 10 AS high$, 10 AS pf$, 10 AS uf$
6 GET 1, 1
7 LOCATE 1, 30: PRINT "REVISE CAPFAX.DAT FILE"
8 LOCATE 3, 1: PRINT "Zero Offset: "; zero$
9 LOCATE 4, 1: PRINT "Low Factor: "; low$
10 LOCATE 5, 1: PRINT "High Factor: "; high$
11 LOCATE 6, 1: PRINT "pF Limit : "; pf$
12 LOCATE 7, 1: PRINT "uF Limit : "; uf$
13 LOCATE 9, 10: PRINT "Change (Y/N)? ";
14 GOSUB yesno: IF a$ = "N" THEN GOTO endit
15 z$ = zero$: l$ = low$: h$ = high$: p$ = pf$: u$ = uf$
16 getnewones:
17 VIEW PRINT 3 TO 23: CLS : VIEW PRINT
18 LOCATE 3, 1: PRINT "Zero Offset: "; z$
19 LOCATE 4, 1: PRINT "Low Factor: "; l$
20 LOCATE 5, 1: PRINT "High Factor: "; h$
21 LOCATE 6, 1: PRINT "pF Limit : "; p$
22 LOCATE 7, 1: PRINT "uF Limit : "; u$
23 LOCATE 9, 10: LINE INPUT "New Zero Offset..."; z$
24 IF z$ = "" THEN z$ = zero$ ELSE LSET zero$ = z$ + " "
25 LOCATE 9, 28: PRINT z$
26 LOCATE 10, 10: LINE INPUT "New Low Factor..."; l$
27 IF l$ = "" THEN l$ = low$ ELSE LSET low$ = l$ + " "
28 LOCATE 10, 27: PRINT l$
29 LOCATE 11, 10: LINE INPUT "New High Factor..."; h$
30 IF h$ = "" THEN h$ = high$ ELSE LSET high$ = h$ + " "
31 LOCATE 11, 28: PRINT h$
32 LOCATE 12, 10: LINE INPUT "New pF Limit....."; p$
33 IF p$ = "" THEN p$ = pf$ ELSE LSET pf$ = p$ + " "
34 LOCATE 12, 28: PRINT p$
35 LOCATE 13, 10: LINE INPUT "New uF Limit....."; u$
36 IF u$ = "" THEN u$ = uf$ ELSE LSET uf$ = u$ + " "
37 LOCATE 13, 28: PRINT u$
38 LOCATE 15, 10: PRINT "Change (Y/N)?";
39 GOSUB yesno: IF a$ = "N" THEN GOTO endit ELSE GOTO getnewones
40 endit:
41 VIEW PRINT 3 TO 23: CLS : VIEW PRINT
42 LOCATE 3, 1: PRINT "Zero Offset: "; zero$
43 LOCATE 4, 1: PRINT "Low Factor: "; low$
44 LOCATE 5, 1: PRINT "High Factor: "; high$
45 LOCATE 6, 1: PRINT "pF Limit : "; pf$
46 LOCATE 7, 1: PRINT "uF Limit : "; uf$
47 LOCATE 15, 10: PRINT "Save (Y/N)? ";
48 GOSUB yesno: IF a$ = "N" THEN CLOSE : PRINT "NO SAVE": LOCATE 18, 1:
49 END
50 PUT 1, 1: CLOSE : PRINT "New Data Saved.": LOCATE 18, 1: END
51 yesno:
52 a$ = UCASE$(INPUT$(1))
53 SELECT CASE a$
54 CASE "Y"
55 RETURN
56 CASE "N"
57 RETURN
58 CASE ELSE
59 GOTO yesno:
60 END SELECT

```

REVISE CAPFAX.DAT FILE

```

Zero Offset: 75
Low Factor : 2195000
High Factor: 25000
pF Limit   : 1000
uF Limit   : 10000

```

Change (Y/N)?

FIG. 2—CAPFAX.EXE calibrates and sets the range-switching values for the main program, CAP.EXE.

0.1 μ F capacitor for which you know the exact value. If you don't have one, use a capacitor marked 0.1 μ F with the best tolerance you can find (at least 5% or 10%).

Begin by executing CAPFAX.EXE; you'll see a screen like that shown in Fig. 2, except that the five values will all be 0.0. To change values, press Y, and then

PARTS LIST

All resistors are 1/4-watt, 5%, unless otherwise noted.

R1—10 megohms

R2—100,000 ohms

Semiconductors

IC1—555 timer

IC2—4066 quad bilateral switch

Other components

P1—25-pin male D connector

Miscellaneous: 0.1 μ F high-tolerance capacitor for calibration, solderless breadboard, five-volt power source, wire, solder, etc.

Note: The following is available from JJ Barbarello, RD#3, Box 241H, Tennent Road, Manalapan, NJ 07726: Compiled version of the software (CAP and CAPFAX), with datalogging, on 5 1/4-inch double-density PC diskette, \$8.00. The author will be happy to answer any questions. Please include a self-addressed stamped envelope for reply.

enter the following values as a starting point.

- Zero Offset: 0
- Low Factor : 1
- High Factor: 1
- pF Limit : 1000
- μ F Limit : 10000

After entering those values, respond by pressing N (No) to the Change question. Respond Y (Yes) to the Save question to create the initial CAPFAX.DAT file.

Now connect the circuit to your PC's printer port, but make sure there is no capacitor connected to the test points. Apply power to the circuit and start the software by typing the command CAP at the DOS prompt.

The screen will display some value of capacitance, and a count in the lower right hand corner. Press M to measure again. Disregard the value displayed, but note the count, which should be between 5 and 100, depending on your particular PC and circuit construction). That value is the zero offset.

Next connect the known 0.1 μ F capacitor and press M to measure. Again, disregard the value displayed, but note the count. Multiply that number by 10 to obtain the low factor. For example, if the count is 123456, the low factor is 1234560. Leave the 0.1 μ F capacitor in the circuit.

Execute CAPFAX again and en-

ter the appropriate values into the Zero Offset and Low Factor fields. Also, change the μF limit to 1. Save the new data and re-execute CAP. Press M to measure. Disregard the value, but note the count, and multiply it by 10 to obtain the high factor. For example, if the count is 1234, the high factor is 12340. Execute CAPFAX one more time to enter the high factor and change the μF limit back to 10000. Save the revised data.

Use

Using the PC-based capacitance meter is straightforward. With your PC on and the meter connected to the printer port, apply power to the meter. At the DOS prompt, type CAP and press Enter. Insert the capacitor to be measured, and press M. The value appears in the middle of the screen, and the bottom indicates the range (pF, μF low, μF high), along with the timer count. To end the program, press E.

The μF limit and pF limit factors are used to determine how to format the measured value. If you measure a capacitor that displays 0.00 μF , but has a count greater than 0, you are in a "no-man's land" between the two limits. Execute CAPFAX and increase the pF limit factor. Doing so increases the pF formatting range and allows the measured value to be displayed properly.

Remember that if you vary the meter circuit or your PC, you should recalibrate the software to maintain accuracy.

Next Time

In the near future we'll incorporate the capacitance-measurement circuitry into a combination instrument that measures resistance, capacitance, and voltage. The device allows you to measure resistors, capacitors, diodes, and transistors. Because it is computer controlled, it can be the heart of an automated inspection system for your shop or business. You can save a lot of troubleshooting time by ensuring that the IC's you plan to use in a project function properly before you use them. The last project in this series is an IC tester that allows you to verify operation of most 14- and 16-pin TTL and CMOS IC's.

R-E

DRAM TESTER

continued from page 40

to operate a few minutes for maximum stability, set R5 at 100 ns on the dial, and adjust R19 for a

low clock pulse of 200 ns. Measure the pulse at the 1.0-volt DC level. Next turn R5 fully counterclockwise; the low clock pulse should be 150 ns. Turn R5 fully clockwise; the low clock pulse should be 300 ns—if not, adjust R17 for the proper "dial spread."

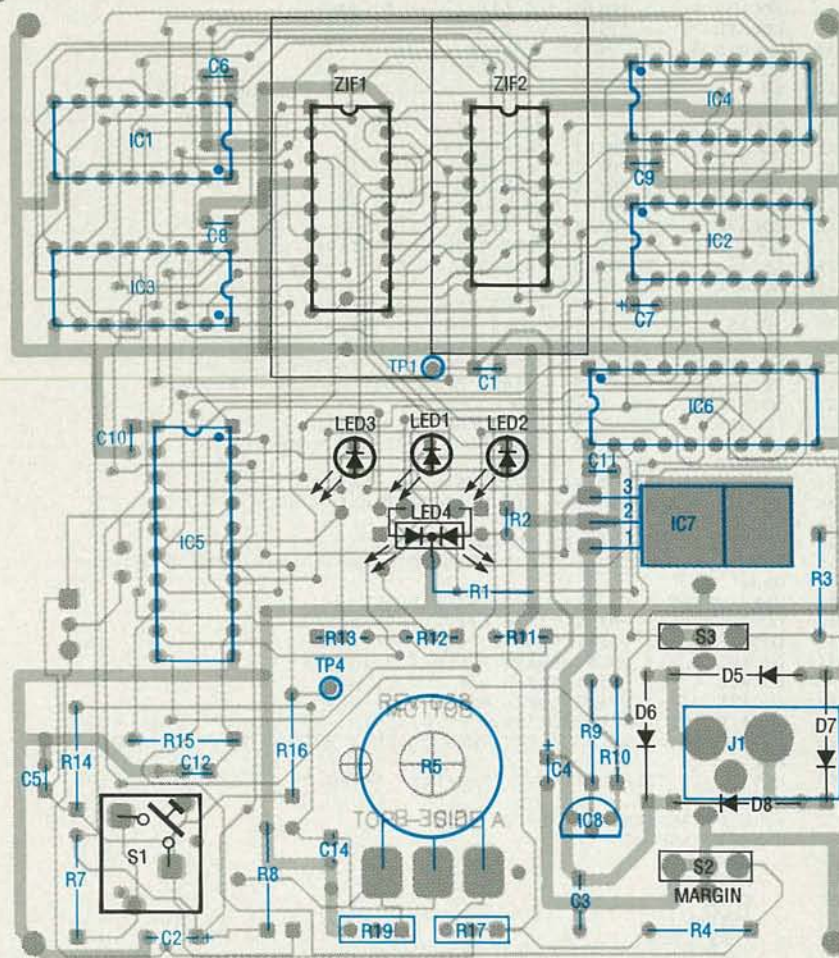

FIG. 9—PARTS-PLACEMENT DIAGRAM. The parts shown in color are installed on the "bottom," or solder side of the board—that is, the side opposite that with the ZIF sockets.

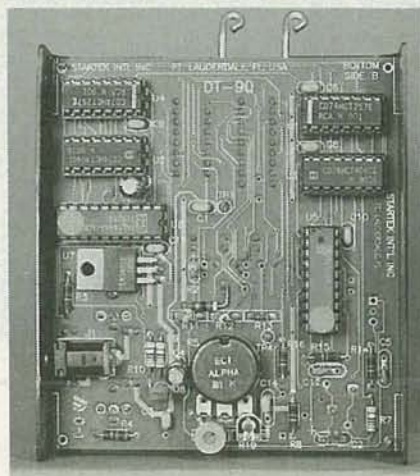

FIG. 10—THE FINISHED BOARD is neat and compact—and, of course, quite useful.

The R17 and R19 adjustments will interact somewhat, so adjust by small increments, and again calibrate R19 at the 100-ns dial setting with R5 after each change to R17. This adjustment should be easy; both potentiometers should end up somewhere near midrange.

If you do not have a scope immediately available to calibrate the access-time control, set R17 and R19 to midrange, which should be near calibration, and use the speed test for a relative indication; the function and voltage margin tests should work fine. All you have to do now is install the unit in an appropriate case and put it to good use. R-E

ROGER P. NEWELL*

A NEW ERA OF PERSONAL COMMUNICATIONS may be just over the horizon. Imagine the freedom and mobility of making and receiving calls away from your desk and home—in the street, roaming around your office, or even on the golf course. This new service will be provided by Personal Communications Networks (PCN's), which are radio-telephone networks designed to run parallel to, and compete with, the Public Switched Telephone Network (PSTN) that we are all familiar with.

PCN's are intended to provide mobile telephone service with quality and reliability equivalent to wireline. The handset is a digital radio designed to permit privacy and security that meet the standards of a fixed network, with usage rates that are comparable, or only slightly higher, than those charged by wireline services. Those advantages can come only if there is a large number of subscribers. A further objective of PCN's is to make efficient use of the radio spectrum in order to have as large a capacity as possible.

What is a PCN?

A generally accepted definition of a PCN is that it is a complete telephone system, running parallel to (and competing with) the traditional fixed telephone system. A PCN consists of pocket radio telephones communicating with fixed base stations in the street or in buildings. PCN's will permit any person to make or receive telephone calls, no matter where he or she might be—at home, on the street, or in the office. Using digital radio techniques in combination with a low-cost pocket-sized handset, the PCN will provide a fully mobile service with enhanced quality and all the features and functions of a standard telephone system. The underlying idea is that calls should be made to a person, not a place. By assigning a personal telephone number to an individual (rather

PERSONAL Communication NETWORKS

Can microcell technology of PCN's make mobile communications truly affordable for everyone?

than a line from the phone company's central office) the PCN will be able to ensure that the customer is always able to be reached in an instant.

A more basic system, called Telepoint, operates as a radio pocket payphone, allowing calls to be placed whenever the user is within radio range of a base station installed by the Telepoint operator. When a subscriber wants to make a call, he or she goes within radio range of a public base station installed by the Telepoint operator, opens the handset and punches in a personal identification number (PIN). The base station will validate the PIN, and accept the dial information. The call is then extended through the public telephone network. The base station collects information on the caller's identity (transmitted by the handset) and the duration and distance of the call. The Telepoint company will send a bill to the customer for all calls that happen to have been made during the month.

Market demand

The desire for communications mobility is strong. A.D. Little, a respected marketing consultant firm, has done market research that indicates that a large fraction of the nation's households would gladly subscribe to a PCN. Although market demand depended on the price of the

handset and the monthly charges for the service, 40% of all households surveyed were likely to subscribe to PCN's, assuming monthly service charges of \$10 per month over the consumer's current telephone bill, and a handset price of \$100. When the service premium increased to \$40 per month, and handset prices to \$250, 14% of all households indicated the willingness to buy PCN service—and that's only the residential market. Between 25 and 35% of all businesses were likely to subscribe to PCN's.

A.D. Little concluded that the interest in PCN's is nearly double that of most other new services. It also found that annual revenues from personal communications will range from \$10 billion in the first year or two to over \$30 billion as the service matures. That's enough to make even a telephone company's mouth water, and explains the current high interest in personal communication networks.

How it works

In some ways PCN's are similar to cellular telephones. In each case, the radio telephone transmits signals to a fixed base station, which then connects the call to another subscriber, or the public-switched telephone network. The fundamental difference is that PCN's use ex-

*Roger P. Newell is a telecommunications attorney practicing in New York City. He is also editor of *Microcell Report*, a monthly newsletter on microcell technology.

tremely low power for the radio link between the handset and the base station—about 10 milliwatts peak power compared with 600 milliwatts for cellular portables, and 3 watts for a car telephone. Low power means short range, which would seem to be a severe drawback for a radio telephone, but is actually the reason for the current intense interest in PCN's. With a short range, it is necessary to have very large numbers of base stations, each covering a microcell whose radius is from 200 meters to perhaps half a kilometer. In comparison, cellular cells are usually several miles wide.

Since the spectrum can be reused in each of those microcells, PCN's are more spectrum efficient than cellular phones, and can provide service to many more people. With such a large capacity, the investment cost per subscriber can be kept extremely low. The initial cost of a PCN is expected to be about \$300 per subscriber, compared with \$800 for cellular and \$1,600 for wireline networks.

In addition, the use of low power also brings manufacturing advantages into play. If the handsets broadcast at low power, less power is needed in the battery, which means smaller batteries, and therefore, smaller terminals and micro-miniaturized components are used. All that translates into longer talk time, with lower prices available to the public.

Spectrum scarcity

Microcell technology has the potential to change the way we communicate, and to be a prodigious revenue-producer for those supplying the equipment and service. Yet PCN's are not springing up all over the landscape. The reason is that an essential element is in short supply—the radio spectrum for handset-to-base transmissions. Virtually all of the technically appropriate spectrum has been allocated to users who guard it with the intensity of a bear protecting her cubs. The Federal Communications Commission (FCC) and industry are attempting to find a path through the spectrum thicket. The FCC could, in theory, clear spectrum

for a PCN service simply by reallocating a slice away from current users; but past experience has shown that trying to remove a slice of the spectrum is like walking into a buzzsaw.

As an alternative, spectrum could be assigned to PCN on a co-primary (sharing) basis, or on a secondary basis, requiring PCN operators to defer to the primary users of the spectrum. But sharing leaves the operators unsure of whether their spectrum is sufficiently solid to warrant the high investments needed to set up their systems. Either method would involve bloody battles in the halls of the FCC between the spectrum haves and have-nots, and would take several years to resolve.

So companies throughout the telecommunications industry are exploring ways to bring to consumers the benefits of low-cost mobile phones, despite the shortage of frequencies. Over 50 applications for experimental licenses for PCN's and Telepoints have been filed in the U.S., and 13 in Canada, seeking to test a variety of technologies. For example, one company which owns a network of interbuilding microwave systems in New York City, will test its use as the backbone distribution network for a PCN. Many applicants, especially the Bell

Operating Companies, plan to hedge their bets by testing everything in sight. At this time, most of the testers are still in the preparatory stage, and that is the reason why few results have been publicly reported.

CT2 systems

One system, called Cordless Telecommunications, 2nd Generation (CT2), is drawing interest because it uses comparatively little spectrum. It can be used for Telepoint, residential cordless phones, and wireless PBX's for use in offices. The technique uses frequency-division multiple access (FDMA) to divide four megahertz of spectrum into 40 channels of 100 kilohertz each. The handset checks each of the 40 channels at 750 millisecond intervals, and if it finds another channel with less interference, it will switch to the new channel. When used for residential cordless telephones, CT2 has marketing advantages over current analog cordless telephones, since CT2 telephones tend to be smaller, have a greater range, and are more difficult to be overheard by one's neighbors.

CT2 operates in the 800–1000 MHz range, but only three megahertz of spectrum remain unassigned in that range, and those frequencies were promised to

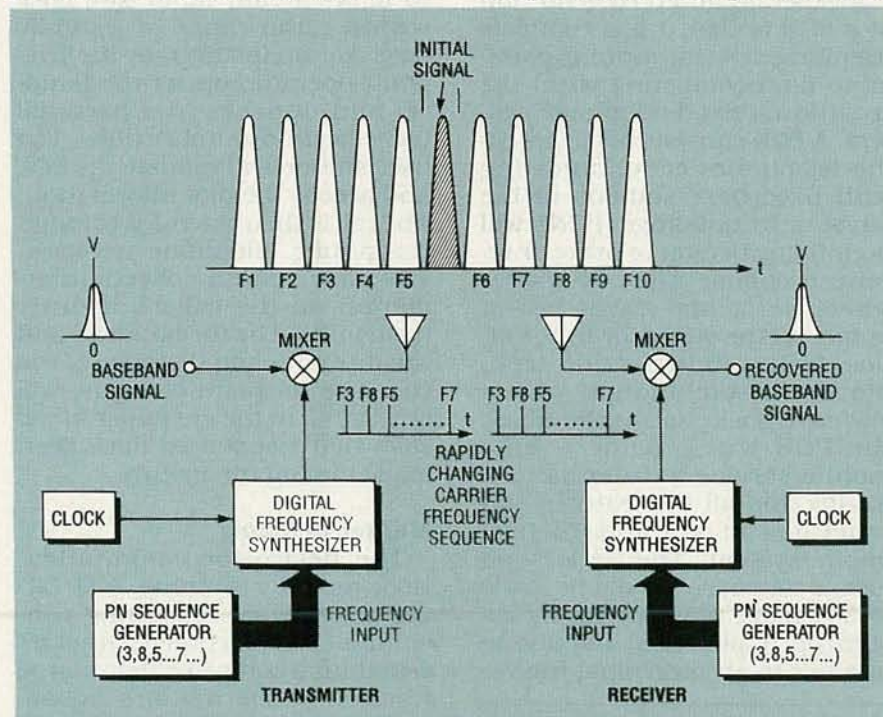

FIG. 1—A FREQUENCY HOPPING SYSTEM. Pseudorandom noise sequence generators in the transmitter and receiver are used to output the same frequency-hopping sequence.

other mobile phone users. An assignment to a Telepoint service would, however, run into intense opposition from companies already in the market that had hoped to use the spectrum for other mobile uses.

CT2 plus

Another possibility lies in the use of a more spectrum efficient version of CT. Northern Telecom has proposed that the 3-MHz slices in the 900-MHz band be used for control channels, while actual communication will take place over a 30-MHz band, occupying parts of the spectrum not being used by point-to-point microwave operators in any particular location. Interference with microwave operators would be avoided by use of "smart" base stations which would have the ability to sense which frequen-

cies are being used by microwave channels and would block those frequencies off from the handsets.

The FCC's Chief Engineer, Dr. Thomas Stanley, presented the possibility that the 4 MHz being considered for allocation to the air/ground telephone service could be shared by microcell users. That may be feasible since the air/ground use is not likely to be heavy in any one location at any given time.

Cellular frequencies

Dr. Stanley also pointed out that under a recent FCC order, cellular operators are free to use their allotted spectrum for auxiliary services, providing the primary service of cellular telephony is not affected. Up to 50 MHz of cellular spectrum could be used for a PCN-type service, assuming

that a cellular operator would take precious spectrum away from the higher-priced cellular services. The hitch is that frequencies used for PCN's would have to be taken away from the profitable cellular service. Nevertheless, NYNEX has announced that it would use a portion of its cellular frequencies to build PCN's in New York and Boston, and is expected to be operational by 1992.

Spread spectrum

Vast numbers of radio devices operate today with no license at all under the FCC's Part 15 regulations for low-powered devices, including such things as garage-door openers and existing analog cordless telephones. A personal communications system operating at 10 milliwatts or less of radiated power would fall under the power limitations of Part 15, and would be allowed to operate at any frequency, but would have to accept interference from existing and future licensed operations, as well as any other Part 15 devices. That's a very uncertain foundation for a large investment.

One potential solution is to share spectrum through "spread-spectrum" technology. Several experimental PCN's have been set up to explore that option, including PCN's to be built in Houston and New Orleans by a subsidiary of Millicom, Inc. If successful, they will pave the way to establish a personal communications service despite the frequency crunch. Results are expected by the end of 1991. Although spread spectrum has been criticized as expensive, and untried in public telephony, it may offer the only hope in the U.S. of getting a PCN service off the ground.

Spread-spectrum modulation was originally developed by the military to permit jam-proof and undetectable radio communications. Those are the qualities that permit low-power radio links without interference to or from other radio transmissions. By spreading signal strength over a wide bandwidth, the energy transmitted at any one frequency in the band is low, which effectively reduces the chance of harmful interference.

Using spread-spectrum tech-

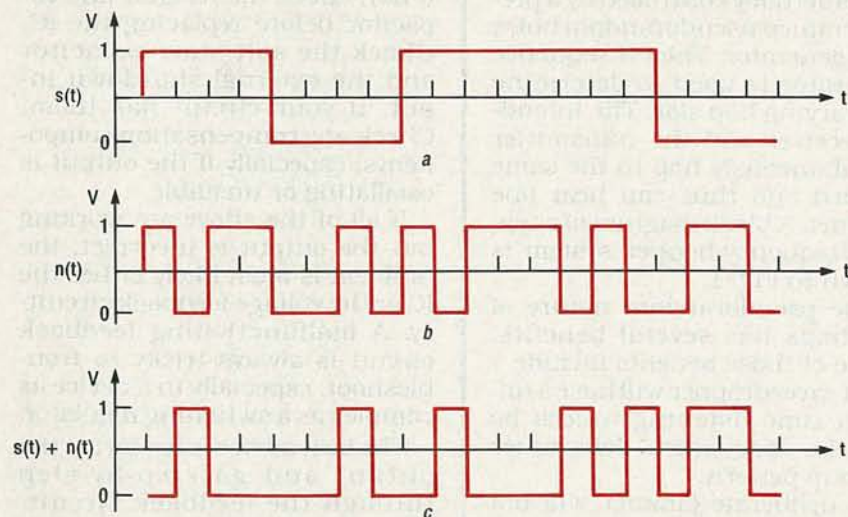

FIG. 2—SPREAD-SPECTRUM SIGNAL. The carrier signal (a) is modulated by a noise signal (b), resulting in a summed signal, with an expanded bandwidth.

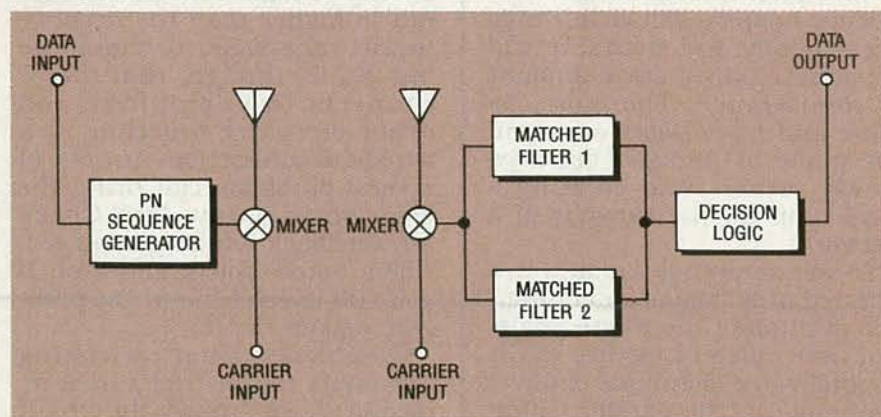

FIG. 3—DIRECT SEQUENCE uses multiple matched filters to reduce noise and increase successful correlation between the receiver and transmitter. Decision logic selects the filter output that is most likely to be correct.

**DISCOVER
EXPERIMENT
LEARN
ADVANCE
ELECTRONICS
LASERS
CAD-CAM
HOME STUDY
HEATHKIT
HOMEWORKS!**

Now you can learn beginning to advanced electronics at home, with the same courses used today in the world's top colleges and tech schools, and pay a lot less! You'll learn just what you want, when you want, at your own pace. The complete story is in our free catalog, HomeWorks by Heathkit. Order yours today, call toll-free:

1-800-44-HEATH
(1-800-444-3284)



YES! Please send me a FREE copy of the HomeWorks by Heathkit Catalog.

Send to: Heath Company, Dept. 020-056
Benton Harbor, Michigan 49022

Name

Address

City

State Zip

ED 240 Bull Data Systems, Inc.

CIRCLE 193 ON FREE INFORMATION CARD

niques, information is transmitted over a wide bandwidth using a pseudorandom pattern. User-specific codes are transmitted by each sender to permit the intended receiver to select out the relevant transmission. There are two primary methods that are traditionally used to do that; they are frequency hopping and direct sequencing.

Frequency hopping is conceptually very simple. In transmitting a traditional narrow-band signal, the carrier frequency is changed, or "hopped," to one of a great many frequency slots many times per second over a large number of channels. The resulting signal has an expanded hopped bandwidth, which is often in the order of a few hundred MHz.

The hopping pattern may seem to be an unpredictable sequence, but is actually controlled by a predetermined pseudorandom noise (PN) generator. The PN sequence generator is used to determine the varying hop slot. The intended receiver and the transmitter simultaneously hop to the same pattern and thus can hear one another. A block diagram of a typical frequency-hopper system is shown in Fig. 1.

The pseudorandom nature of the hops has several benefits. Some of those benefits include

1. An eavesdropper will have a difficult time listening unless he has the code which determines the hop pattern.

2. A deliberate jammer will not know where to put his transmitter on the band of frequencies since the frequency hopper dodges the jammer.

3. Multiple, uncoordinated frequency hoppers will collide only occasionally and therefore will experience only a small amount of interference. Therefore, as more and more users come on, the quality of the signal degrades slowly rather than creating a hard limit on the capacity of a network.

Direct sequence, sometimes referred to as "signal shredding," accomplishes the same goals, but uses different tactics. In the sophisticated technique of direct sequencing, the carrier (information) signal is digitally modulated by the noise signal. Figures

continued on page 74

SWITCHING SUPPLIES

continued from page 55

sion components. Failure of those will allow high voltage spikes, possibly destroying switching transistors or rectifier diodes. Incidentally, always use identical or approved replacement parts for diodes and switching transistors. Slow "garden variety" components will fail quickly, possibly taking other components with them.

Before replacing the IC, go through the circuit function-by-function. Try to narrow the problem to one area of the circuit and see if any external components have failed. Is the IC's internal regulated voltage correct? If not, the failure almost certainly is in the IC. Is the oscillator running? If not, check the resistor and capacitor before replacing the IC. Check the soft-start capacitor and the external shutdown input, if your circuit has them. Check any compensation components, especially if the output is oscillating or unstable.

If all of the above are working but the output is incorrect, the problem is most likely either the IC or the voltage feedback circuitry. A malfunctioning feedback circuit is always tricky to troubleshoot, especially in a device as complex as a switching regulator.

The best advice is to start at the output and go step-by-step through the feedback circuit. The voltage divider's input-to-output ratio should be correct, even if the voltage isn't. An op-amp or comparator's output should be high if the positive input is higher than the negative input; otherwise, it should be low. (Note, though, that the IC connects two amplifiers and other circuitry together in a wired-OR connection. Any one of several problems can bring the error amp's output low.) Check any feedback windings and rectifiers, optocouplers, and so on. If you still haven't found the problem, replace the IC.

Troubleshooting switching regulators can be tricky. Just remember to go through the circuit step-by-step, and keep the basics in mind when you encounter problems.

R-E

HARDWARE HACKER

More on toner-cartridge reloading and Santa Claus machines, and some VHF and Microwave resources.

DON LANCASTER

Every now and then, it seems a good idea to go back over some of our older *Hardware Hacker* subjects and bring them up to date. Certainly one of the most popular topics ever found on our helpline involves...

Toner cartridge reloading

PostScript and other laser printers are fast becoming a major industry. There are many millions of units now in use. By far the best and the most popular versions use several styles of laser engines made by *Canon*. These engines were originally intended to accept a throwaway plug-in cartridge. Inside the cartridge is a source of toner, a photosensitive drum, and a spent-toner holding tank.

Played according to the rules, you buy these cartridges for \$120, use them for 4000 copies, and end up with a per-page toner cost of three cents.

As we have seen before, you can easily reload these cartridges yourself dozens of times. Today, you can do so in two minutes for a cost of \$6.50 or less, and can easily reduce your per-page toner costs to 0.2 cents per page, a whopping 15:1 cost improvement.

Besides saving big bucks on your own printer, you could also resell recharged cartridges for as much as \$15 or even \$19 each, as part of an ongoing neighborhood service.

There's lots of exciting new things happening in the toner recharging industry, so I thought we might pick up some fundamentals and then bring you up to date on the newest and the best insider secrets.

What is toner? Well, it is a mixture of (usually) black stuff and hot glue. Specifically, toner is a fine powder which has very precisely controlled magnetic, electrostatic, thermal, and visual properties. Most toners are basically a mixture of ferric oxides, polyethylene, and lubricants.

Toner starts out in the cartridge's

fresh toner tank. A magnetized roller then picks up a very uniform layer of toner. Meanwhile, a nearby photosensitive drum gets flooded with light and then electrostatically charged. It next gets selectively discharged by a laser beam, leaving a charge pattern on the drum. As the drum rotates, it passes very near the magnetic roller and the toner selectively jumps onto the drum, sticking by electrostatic forces only where you want an image.

As your drum rotates further, it passes very close to a highly charged piece of paper, and the toner particles then jump onto the paper. Any remaining toner that was left on the drum gets scraped off and routed to a *spent-toner holding tank*. The photosensitive drum then continues on its way for another cycle.

Meanwhile, you now have your image on the paper. But it is only held there by gravity and by rather weak electrostatic forces. It will easily smear if you touch it. The paper then goes on to a *fusion roller* assembly. Heat and pressure will melt the toner and force it into the paper, giving you a fairly durable final hard copy.

One very important part of most fuser assemblies is the *wiper pad*. The wiper pad has a small amount of silicon oil on it that both lubricates and cleans up any remaining toner on the pressure rollers. Wiper pads are usually replaced whenever a cartridge is recharged. Note that just washing a wiper pad is a no-no.

Our first rule: Toners vary from machine to machine. Most *Canon* laser

printers use what is known as a *black write* system, since laser diodes will last much longer this way. On the other hand, all but the newest and most expensive copiers use a *white write* system so that light ends up as white and dark as black.

Thus: *Copier and Laser-Printing toners must NEVER be interchanged or substituted for each other!* There are usually mechanical interlocks that prevent you from plugging a copier cartridge into a laser printer and vice versa. If you attempt to defeat those interlocks, you will end up using the wrong toner. At the very least, that gives you useless copies, and at worst, it can cause serious damage.

Similarly, toner chemistry varies from printer to printer, especially between manufacturers. Our second rule: *The refill toner you use must be pretested in and rated for the exact cartridge you are refilling.*

So where do you get refill toner and the wiper pads? My two favorite sources are *Don Thompson* and *Lazer Products*. There is also one outfit called *Black Lightning* that stocks specialty toners for T-shirt and fabric printing uses.

The toner industry has its own trade journal. It is called *Recharger*, and is chock full of supplier ads and useful industry info. There are also at least a dozen recharging associations who do have lots of seminars and conventions. Details on those usually appear in *Recharger*.

The big news today in toner refilling involves new third-party hard coated drums. For some reason or another, the factory stock drums are made needlessly soft. The third-party drums instead are ultra-hard and can easily be used for dozens of reloads. One leading importer of hard drums is *CopyMate Products*.

Let's look at some specific refilling details. Certainly the most popular cartridges are those used in the *Canon CX, SX, and LX* engines. Figure 1 lists many popular laser printers

NEED HELP?

Phone or write your **Hardware Hacker** questions directly to:
Don Lancaster
Synergetics
Box 809
Thatcher, AZ 85552
(602) 428-4073

HP MANUAL	HP PRINTER	APPLE PRINTER	QMS PRINTER
02686-90920 (CX Engine)	LaserJet I	LaserWriter LaserWriter Plus	PS800
33449-90906 (SX Engine)	LaserJet II LaserJet III	LaserWriter NT LaserWriter NTX	PS810 & Turbo PS820 & Turbo
33459-90906 (SX Engine)	LaserJet IID LaserJet IIID	-----	-----
33471-90904 (LX Engine)	LaserJet IIP	Personal LW NT	PS410

FIG. 1—HERE'S A LIST of all the most popular PostScript laser printers, their equivalent service manuals, and the style of toner cartridges they use.

and the specific engine used in each one. Figure 1 also reveals to you the outstanding *Hewlett-Packard* repair and service manuals involved. The manuals, and all major parts, can be had overnight via VISA/800.

For some reason which I simply cannot fathom, *Apple Computer* absolutely insists that you use the HP

service manuals to keep your Apple LaserWriter printers alive. As near as I can tell, this is some sort of a top-secret rebate policy.

At any rate, you can recognize the older CX cartridges by their large three-inch drums, their red-yellow-green end dial, and their obvious lunchbox handle. While the original LaserWriter and all similar printers using them are rather dated, they do remain useful, especially when printing lots of heavier stock. Many used bargains are now cropping up involving these machines. Two sources are

Don Thompson and The Printer Works.

Non-PostScript laser printers, of course, are an utterly useless ripoff, so be absolutely certain that your used machine can speak genuine Adobe PostScript.

Before we begin, note that the photosensitive drums must *never* be exposed to strong light, or to *any* light at all over any long period of time. Never get fingerprints on the drum. Cotton gloves are a good idea.

Toner is an ultra fine powder that can end up all over everything. It is sometimes best to work outside, possibly wearing a mask. Toner can, in theory, explode a vacuum cleaner, but that rarely will happen. But do be careful.

The general steps in refilling any cartridge are fivefold:

- (1) Remove and discard any waste toner from the spent toner holding tank. Do not reuse the spent toner.
- (2) Refill your fresh-toner supply tank with a new bottle.
- (3) Lubricate the drum with a light dusting of *Pixie Dust* (see below).
- (4) Replace the oiled wiper felt on the fusion assembly elsewhere in the printer.
- (5) Update accurate life and service records on a suitable label.

Figure 2 shows you those CX refilling details. There is really never any

NEW FROM DON LANCASTER

HARDWARE HACKER STUFF

Hardware Hacker Reprints II or III	24.50
Incredible Secret Money Machine	12.50
CMOS Cookbook	24.50
TTL Cookbook	19.50
Active Filter Cookbook	19.50
Micro Cookbook vol I or II	19.50
Lancaster Classics Library	109.50
Enhancing your Apple I or II	17.50
AppleWriter Cookbook	19.50
Apple Assembly Cookbook	21.50
Absolute Reset IIe & IIc	19.50
Enhance I or II Companion Disk	19.50
AppleWriter CB or Assy CB Disk	24.50

POSTSCRIPT STUFF

Ask The Guru Reprints I, II or III	24.50
LaserWriter Secrets (IIe/Mac/PC)	29.50
PostScript Show & Tell	39.50
Intro to PostScript VHS Video	39.50
PostScript Beginner Stuff	39.50
PostScript Cookbook (Adobe)	16.50
PostScript Ref. Manual (Adobe)	22.50
PostScript Program Design (Adobe)	22.50
Type I Font Format (Adobe)	15.50
LaserWriter Reference (Apple)	19.50
Real World Postscript (Roth)	22.50
PostScript Visual Approach (Smith)	22.50
Thinking in PostScript (Reid)	22.50
The Whole Works (all PostScript)	299.50

FREE VOICE HELPLINE VISA/MC

SYNERGETICS

Box 809-RE
Thatcher, AZ 85552
(602) 428-4073

CIRCLE 83 ON FREE INFORMATION CARD

To refill an older CX cartridge with the punch-and-go method, you first snap off the cardboard label and then drill a toner filling hole...

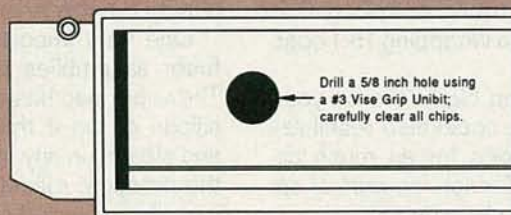

A second CX hole is needed to let you empty the spent toner holding tank. This area is found underneath the cartridge...

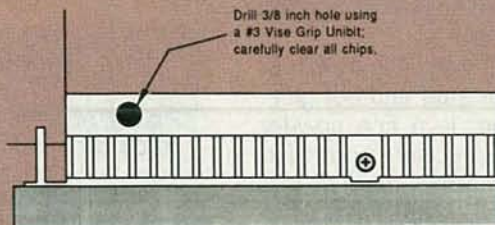
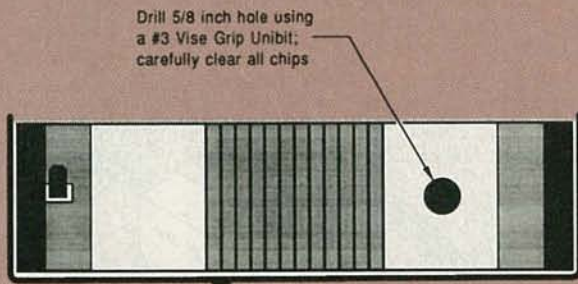

FIG. 2—THE CX CARTRIDGE is easily recognized by its large drum and its obvious "lunchbox" handle. Here are my "punch-and-go" refilling secrets.

The SX cartridge punch-and-go refilling process is similar to the CX, except for the hole locations. The filler hole is shown here...



One or more spent toner drain holes must also get added to the SX cartridge. The plastic is thin, so use a conical step drill...

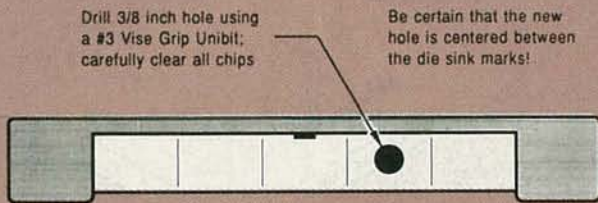

FIG. 3—THE SX CARTRIDGE is wider than it is high, has a small drum, and is the most popular cartridge for the larger 8-PPM PostScript laser printers.

reason to tear down a CX cartridge, except to substitute a hard drum. The original factory drums are big enough that you can often get four or five refills as is. For most people most of the time, a total teardown will cause many more problems than it will solve. Remember that your ultimate goal should be minimizing all of your per-page toner costs, not maximizing the number of recharges for each drum. An extra recharge is pointless if it costs the end user more per page to do so.

If you absolutely have your heart set on taking a CX cartridge apart, you'll need two special tools. One is a special tamperproof Torx bit. This is EVCO part number #945B700 and is available from Jensen Tools as well as most refilling supply houses. The second is a special pin-pulling tool called a CX Glompenstractor and available once again through Don Thompson.

Should you use my punch and go method, you will have to drill two holes in the cartridge on your first reload. That is best done using a rather unusual step-drill called a #3 Vise Grip Unibit. They are available from Jensen Tools or from any larger electrical contracting supply house. When used with a variable-speed hand drill, the Unibit cleanly cuts a perfectly round hole in brittle plastic,

while producing a single and easily grabbed chip.

After drilling the holes, the spent toner is shaken or vacuumed out. You can reseal the hole with plain old Scotch Tape (be VERY careful to get a secure seal!), or else use a nickel Caplug. Your fresh-toner hole is sim-

ilarly used to accept a bottle of new toner and then resealed.

Figure 3 shows you the SX cartridge recharging. The LaserWriter NTX is a typical machine that uses this cartridge. The SX cartridges have a one-inch drum and are rather flat looking, being much wider than thick. Should you decide to tear down the cartridge or upgrade to a hard drum, a different glompenstractor is needed having a narrower snout.

The details of my punch-and-go refill method remain pretty much the same. First time around, you drill a suitable filling and emptying hole. Once again, the #3 Vise-Grip Unibit in a variable-speed hand drill is ideal for this. To refill, drain and discard the spent toner and reseal. Then fill the fresh toner tank and reseal.

Figure 4 shows you the newest LX cartridge recharging. The personal laser printers, such as the QMS PS-410, use this cartridge. The LX cartridge is recognized by its small size, an obvious spring, and its "white trim" gears and bearings.

No holes are required. To access the tank, pull the two pins by using ChannelLock #357 end pliers. The tank can then be refilled through the existing Caplug. To change the drum or drain the spent toner, remove the four Phillips screws on those nylon drum bearings and pull the drum.

The LX cartridge does not need any modifications before any refill, hard drum upgrade, or any spent toner draining...

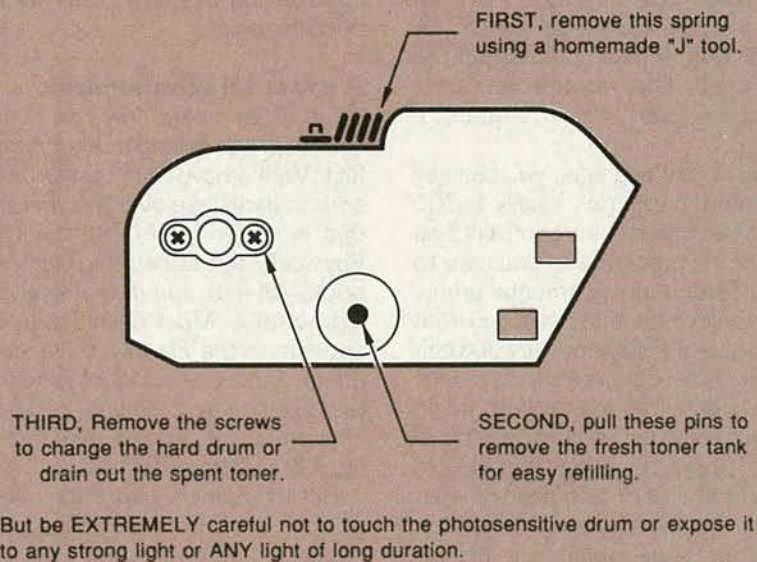

FIG. 4—THE SMALLER LX CARTRIDGE is used in the "personal" 4-PPM printers and is easily spotted by its obvious spring and the "white trim." NEVER use copier toner in a laser printer.

Spent toner can be simply vacuumed or shaken out.

After a recharge, it's a good idea to *very lightly* dust any drum with a suitable lubricant. Many of them are based on plain old zinc stearate. Only don't substitute baby powder since the perfume and oils will do you in. The usual name here is *Pixie Dust*. Pixie dust is available through most recharging supply houses at very low cost. You can make a "duster" from the toe of a child's athletic sock and a rubber band.

Once again, the wiper pad on the fusion assembly should get replaced every time you change the cartridge. You normally keep the old wiper wand and drop a new peel-and-stick oiled nomex felt strip in place.

While you can obtain toner-tank re-sealing strips, travel of any kind is extremely rough on toner cartridges. I do not recommend ever moving a cartridge further than you can gently and personally hand carry it. Nor do I recommend ever swapping your own cartridges for unknown outsiders. I strictly limit my personal recycling service to a six-mile radius. Yours also should be.

Reuse of toner removed from spent-toner holding tanks is not in the least recommended, nor is recycling your own wiper pads.

There does remain plenty of "zoo" aspects to toner recycling. Certain irresponsible manufacturers have begun some high-profile national "recycling" programs which in fact destroy the cartridges rather than recycling them. The hope here is to permanently get the cartridges out of circulation before they could be refilled and reused. Only an absolute idiot would participate in any program of this sort.

If you do nothing else, you can sell your empty cartridges locally for \$5 to \$10 each, and then contribute as much of the proceeds as you care to to your favorite environmental group.

Any salesman that tells you that normal use of a properly recycled cartridge automatically voids your printer warranty is telling you an outright lie for which they can be criminally prosecuted. Some others are literally gold plating stuff that does not in the least need to be gold plated. Yet others substitute shoe polish for proper hard-drum recoating.

Those recharge/repair schools run the gamut from outstanding high-

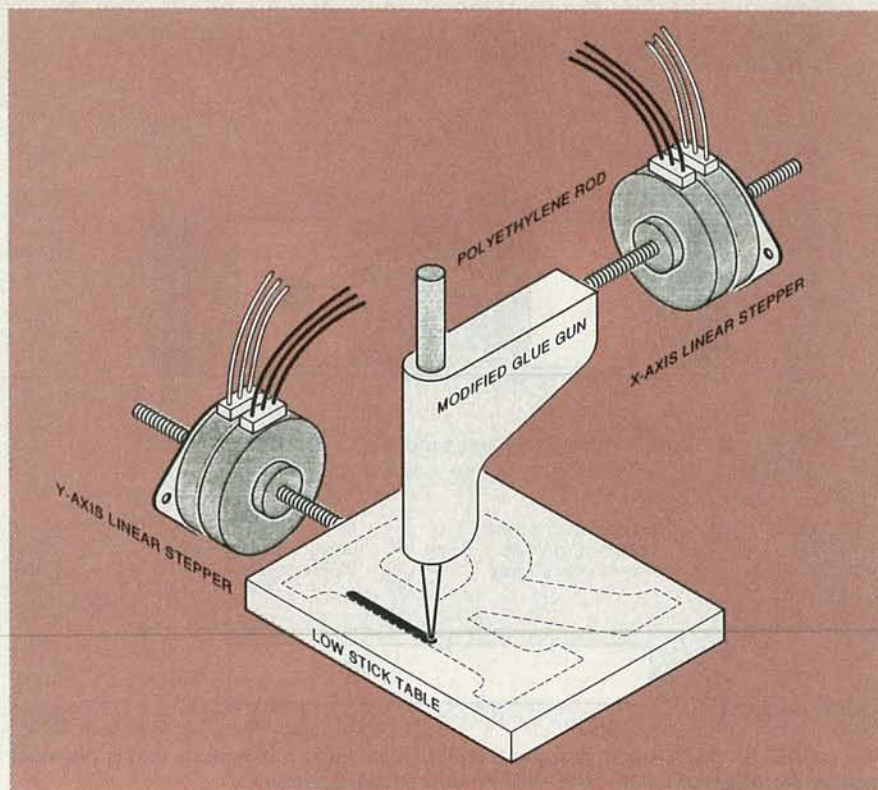

FIG. 5—A "SANTA CLAUS" MACHINE for producing large display letters. The polyethylene bead from the glue gun is programmed to build up the entire letter one strand at a time. While slow, there are no mold charges and the size and style can be instantly changed. Logos and custom characters are a snap.

quality bargains down to outright ripoffs. To tell one from another, ask the school for a list of all previous students in your area. Then call one or two of them.

So, you will have to pay careful attention to details. But the toner recharging industry is fast maturing and now offers all sorts of exciting and cost-saving new hardware-hacking opportunities.

A great telephone book

I'm often asked how I can usually find helpline names and numbers so fast. Well, I have built up my own resource data base over the years, and that is where I will often look first. Physically, this is just a big black notebook with lots of stuff that keeps falling out of it. Most of this data base appears in the *Hardware Hacker* reprints, and a downloadable and annotated selection of the best of the best appears on my *GENie* PSRT library as file #80 MYFAVOR.TXT.

But the number-two place I always go to is the *Electronic Industry Telephone Book* from *Harris Publishing*. While it lists for around \$50 per year, sometimes you can get a free one or promo copy from a sales rep.

This national coverage gem works just like any other phone book, with alphabetical white pages and by-topic yellow classifieds. Their listings are very thorough, and I am continually amazed by how often this one volume can solve so many problems.

Santa Claus again

Several times now, we've taken a look at the new Santa Claus machines that create instant desktop prototypes at a tiny fraction of the time and cost of traditional methods. As we have seen, all the stuff out there so far is primitive, klutzy, and horrendously priced. At least so far.

We've also seen some outstanding new hacker opportunities here, that range from low-cost desktop prototyping alternatives to offering your own prototyping service bureaus using the commercial systems.

While the best possible desktop prototyping solution remains "none of the above," let's look at a pair of new alternatives.

Have you ever played around with your glue gun? While not readily available, you can get polyethylene rods to use as glue sticks. That gives you a method for encapsulating compo-

NAMES AND NUMBERS

Anderson Power Products

145 Newton Street
Boston, MA 02135
(617) 787-5880
CIRCLE 301 ON FREE INFORMATION CARD

Black Lightning

RR 1-87 Depot Road
Hartland, VT 05048
(800) BLACK99
CIRCLE 302 ON FREE INFORMATION CARD

Caplug

2150 Elmwood Avenue
Buffalo, NY 14207
(716) 876-9855
CIRCLE 303 ON FREE INFORMATION CARD

CopyMate Products

20F Robert Pitt Drive
Monsey, NY 10952
(800) 457-0074
CIRCLE 304 ON FREE INFORMATION CARD

Cory Laboratories

Box 261, 823 5th Street
Menominee, MI 49858
(906) 863-9336
CIRCLE 305 ON FREE INFORMATION CARD

Crystek

2351/2371 Crystal Drive
Ft Myers, FL 33907
(813) 936-2109
CIRCLE 306 ON FREE INFORMATION CARD

EVCO

PO Box 36339
Birmingham, AL 35236
(205) 822-5381
CIRCLE 307 ON FREE INFORMATION CARD

GEnie

401 North Washington Street
Rockville, MD 20850
(800) 638-9636
CIRCLE 308 ON FREE INFORMATION CARD

Harris Publishing/EITD

2057-2 Aurora Road
Twinsburg, OH 44087
(216) 425-9000
CIRCLE 309 ON FREE INFORMATION CARD

Hewlett-Packard/Manuals

19310 Pruneridge Avenue
Cupertino, CA 94014
(800) 752-0900
CIRCLE 310 ON FREE INFORMATION CARD

Lazer Products

12741 E Caley Avenue #130
Englewood, CO 80155
(303) 792-5277
CIRCLE 311 ON FREE INFORMATION CARD

LSI Logic

1551 McCarthy Blvd
Milpitas, CA 95035
(408) 433-8000
CIRCLE 312 ON FREE INFORMATION CARD

Maxim

120 San Gabriel Drive
Sunnyvale, CA 94086
(408) 737-7600
CIRCLE 313 ON FREE INFORMATION CARD

National Sandblast

4421 Prospect NE
Albuquerque, NM 87110
(505) 883-1151
CIRCLE 314 ON FREE INFORMATION CARD

Printer Works

3431 Arden Road
Hayward, CA 94545
(800) 235-6116
CIRCLE 315 ON FREE INFORMATION CARD

Recharger

3870 La Sierra Avenue S266
Riverside, CA 92505
(714) 359-8570
CIRCLE 316 ON FREE INFORMATION CARD

Rohm

8 Whatney
Irvine, CA 92718
(714) 855-2131
CIRCLE 317 ON FREE INFORMATION CARD

Rotary Flight International

5555 Zuni SE, Ste 281
Albuquerque, NM 87108
(505) 298-9362
CIRCLE 318 ON FREE INFORMATION CARD

Sony Semiconductor

10833 Valley View Street
Cypress, CA 90630
(714) 229-4195
CIRCLE 319 ON FREE INFORMATION CARD

Statek

512 N Main Street
Orange, CA 92668
(714) 639-7810
CIRCLE 320 ON FREE INFORMATION CARD

Stratasys

7411 Washington Avenue S
Minneapolis, MN 55439
(612) 941-5607
CIRCLE 321 ON FREE INFORMATION CARD

Don Thompson

23072 Lake Center Drive #100
El Toro, CA 92630
(714) 855-3838
CIRCLE 322 ON FREE INFORMATION CARD

nents in high-quality plastic or making your own custom connectors. Or of doing plastic casting at a tiny fraction of the usual mold costs.

Let's carry this one step further as shown in the crude system of Fig. 5. Say you wanted to produce some large display letters in various styles and sizes. Just take a modified glue gun on a linear stepper and a no-stick base on a second linear stepper, and you should be able to put a plastic bead down that follows the shape of the letter. Repeat the process until the entire letter is created. The host computer traces out the proper path to build up the letter one bead at a time.

Admittedly, this is a rather crude system which is limited to thin two dimensional objects. And we haven't properly addressed the third dimension at all. But it is a good starting point that could lead to some exciting new developments.

One suitable stepper would be the *Hurst model SLS*. I've been meaning to work up some more details on this and on Hurst's new EPC-015 controller. Maybe in a future column.

There is a commercial variation of the "hot glue gun" desktop prototyping method. This is the brand new *Stratasys 3-D Modeler*. They refer to their process as *Fused Deposition Modeling*, or FDM.

The system starts with a large roll of .020 or .050 diameter plastic or wax filament. The filament is heated just enough to make its outside tacky. The filament is then laid down into an existing pattern in the same way you can do artsy-craftsy stuff with string soaked in glue.

A three dimensional object is then built up, literally one string at a time. While they have an elaborate CAD software system based upon NURBS splines, the *PostScript* language and any old word processor should be able to do a vastly better job far faster and much cheaper.

The FDM method seems especially well-suited for modeling con-

tainers and other hollow packaging products. But sharp edges appear tricky to do, especially gear teeth. Ultimate costs should be low, since no lasers, fumes, high temperatures, costly materials, or exotic chemicals are involved. The typical speeds approach 1000 inches per minute.

One big problem with the system: Some prototypes can end up looking like something that missed hitting the reject bin in the arts and crafts class. Finer filaments can cure this, but build more slowly.

I'm wondering if a better prototyping solution might not involve two steps. Homes are usually built in a "rough" and "finish" stage. And machinists often work with *near net* stock to try and minimize their total production time. And modelers will often build their model first and then *superdetail* it later.

So perhaps the solution is some system that gets the shape pretty near the way you want it quickly and crudely. A second step would then measure and modify what you have to give for your final precision fit and finish. Let's have your thoughts on this.

VHF and microwave resources

There are all sorts of interesting things going on in those VHF and microwave frequencies found above several hundred megahertz. Amateur television, weather fax reception, cable services, satellite downlinks, cellular phones, sports radar, remote controls, radio astronomy, emergency services, garage doors, altimeters, instrumentation, microwave ovens, and video links are a few examples of hackable opportunities in the VHF and microwave frequency areas.

Unfortunately, all of the hacking rules change in the VHF and microwave range. First, you no longer have individual resistors, capacitors, and inductors.

Instead, the individual resistance, capacitance, and inductance of each component has to be uniquely taken into account, and often done so in a distributed manner. Circuit strays can quickly become totally intolerable. Tolerances of a few thousandths of an inch can make or break a circuit's performance.

Second, testing and measurement often has to be indirect, because

VHF AND MICROWAVE RE-SOURCES

ARRL Handbook

225 Main Street
Newington, CT 06111
CIRCLE 323 ON FREE INFORMATION CARD

Defense Electronics

6300 South Syracuse Way, Ste 650
Englewood, CO 80111
(303) 220-0600
CIRCLE 324 ON FREE INFORMATION CARD

Fair Radio Sales

PO Box 1105
Lima, OH 45802
(419) 227-6573
CIRCLE 325 ON FREE INFORMATION CARD

Hewlett-Packard

PO Box 10301
Palo Alto, CA 94303
(415) 857-1501
CIRCLE 326 ON FREE INFORMATION CARD

M/ACom Semiconductor

43 South Avenue
Burlington, MA 01803
(617) 272-3000
CIRCLE 327 ON FREE INFORMATION CARD

Microwave Journal

685 Canton Street
Norwood, MA 02062
(617) 769-9750
CIRCLE 328 ON FREE INFORMATION CARD

Microwave Product Digest

34 Evergreen Place
Tenafly, NJ 07670
(201) 568-5835
CIRCLE 329 ON FREE INFORMATION CARD

Microwaves & RF

611 Route #46 West
Hasbrouck Heights, NJ 07604
(201) 393-6286
CIRCLE 330 ON FREE INFORMATION CARD

Mini-Circuits Labs

PO Box 350166
Brooklyn, NY 11235
(718) 934-4500
CIRCLE 331 ON FREE INFORMATION CARD

Motorola

5005 E McDowell Road
Phoenix, AZ 85008
(800) 521-6274
CIRCLE 332 ON FREE INFORMATION CARD

Nuts & Volts

Box 1111
Placentia, CA 92670
(714) 632-7721
CIRCLE 333 ON FREE INFORMATION CARD

Plessey Semiconductor

13900 Alton Pkwy, Ste 123
Irvine, CA 92718
(714) 455-2950
CIRCLE 334 ON FREE INFORMATION CARD

Radio Research Instruments

584 North Main Street
Waterbury, CT 06704
(203) 792-6666
CIRCLE 335 ON FREE INFORMATION CARD

Rogers

100 S Roosevelt Avenue
Chandler, AZ 85226
(602) 961-1382
CIRCLE 336 ON FREE INFORMATION CARD

SGS-Thomson Microelectronics

211 Commerce Drive
Montgomeryville, PA 18936
(215) 362-8500
CIRCLE 337 ON FREE INFORMATION CARD

Surplus Trader

Winters Lane Box 276
Alburt, VT 05440
(514) 739-9328
CIRCLE 338 ON FREE INFORMATION CARD

many attempts to directly measure a microwave circuit could severely disrupt what you are trying to measure. Not to mention the high frequencies and weak signal levels involved. Most suitable test equipment also tends to be very specialized, arcane, and quite expensive, and hard to justify.

Third, VHF and microwave parts can be ridiculously costly, since most of them are aimed at gold-plated low-volume military uses.

Fourth, the math, the field theory,

and the advanced technical skills needed to do anything useful at these frequencies goes way beyond electronic fundamentals. A lot of useful microwave information tends to require advanced skills, can be hard to find, and is often classified.

And finally, much of microwave design work is far more art than science. To this day, black magic can be involved, and you either have the right feel for what you are doing, or your circuits simply will not work.

For this month's resource sidebar, I have tried to gather together some VHF and microwave stuff you might find of interest. Obviously, you'll want to start with that *Radio Amateur's Handbook* published by the ARRL. Many of the ham magazines and club activities will also involve the VHF and microwave frequencies. Per a recent rule change, certain new ham licenses don't require Morse code.

By far the leading surplus house carrying microwave radar goodies is *Radio Research Instruments*. However, these folks tend to concentrate on whole systems and refuse to show prices in their flyers. Alternate places to look include *Fair Radio Sales*, *Surplus Traders*, and in the *Nuts and Volts* shopper.

While utterly ancient, McGraw Hill's *MIT Rad-Lab* series should still be scrounging around on the dusty back shelves of the larger technical libraries. Volume One in particular, Ridenour's *Radar System Engineering* has been reprinted a number of times and remains highly useful to this day. Another more recent classic is Merrill Skolnik's *Introduction to Radar Systems*.

As with any field, the free trade journals are your foremost day-to-day resource. While there are several dozen, four I've found useful include *Microwaves and RF*, the *Microwave Journal*, *Microwave Product Digest*, and *Defense Electronics*.

Be sure to check out *Mini-Circuits Labs* for their low-cost broadband amplifier chips, and *Plessey* for their unusual *Satellite Cable and TV Integrated Circuit Handbook*. They also have lots of info on frequency synthesis and high-speed dividers.

Hewlett Packard, of course, makes all kinds of microwave components, as well as high-performance microwave and VHF test instruments. And *Motorola* has a wide variety of high-frequency semiconductors and application notes available.

Two other chip sources include *SGS* and *M/A Com*, while *Rogers* supplies printed-circuit materials and dielectrics useful for microwaves.

Well, that should be enough to get you started. Please let me know what else you think should be added to our resource files.

New tech literature

From *Sony*, there's a new *Memory Data Book*. They also have lots of

great stuff on A/D and D/A converters. From *Rohm*, there's an *Electronic Components Catalog* which includes details on their FM stereo broadcasters and lots of other goodies.

From *LSI Logic*, there's a new group of LR64700 video-compression chips that should revolutionize both still- and moving-picture image storage and transmission.

I get lots of calls asking about hacker-friendly sources for custom crystals. Two of my favorite sources are *Statek* for low frequencies and *Crystek* for higher frequencies. Both have catalogs, data sheets, and app notes available.

A new detailed bibliography on magnetic refrigeration is available through Jerry Hagen at his *Cory Laboratories*. Our unusual hacker magazine for the month is *Homebuilt Rotorcraft* from the *Rotary Flight International* folks, while that free *Maxim Engineering Journal* has all sorts of semiconductor goodies in it. Especially for audio/video switches and power supplies that work off a single AA cell.

Free samples of *Powerpole* connectors are available from *Anderson Power Products Inc.* These are both snap-together modular and sexless. They should be ideal for such things as solar panels.

An interesting sandblasting catalog is available from *National Sandblast*. This is one quick way to spruce up any metal on your prototypes.

Turning to my own products, for the fundamentals of digital integrated circuits, do check into my *TTL Cookbook* and *CMOS Cookbook*. Or to pick up all the goodies at once, try my *Lancaster Classics Library*.

We also now have the *Hardware Hacker III* reprints available, which has the latest and best of all these columns in them. All edited, revised, corrected, and indexed.

Finally, I do have a new and free mailer for you which includes dozens of insider hardware hacking secret resources. Write or call for info. Our usual reminder here that most of the items mentioned appear either in the *Names and Numbers* or in the *Microwave Resources* sidebars.

As always, this is your column and you can get technical help and off-the-wall networking per that *Need Help?* box. The best calling times are weekdays 8-5, *Mountain Standard Time*. Let's hear from you. **R-E**

DIGITAL VIDEO STABILIZER ELIMINATES ALL VIDEO COPY PROTECTIONS



While watching rental movies, you will notice annoying periodic color darkening, color shift, unwanted lines, flashing or jagged edges. This is caused by the copy protection jamming signals embedded in the video tape, such as Macrovision copy protection. Digital Video Stabilizer: RXII completely eliminates all copy protections and jamming signals and brings you crystal clear pictures.

FEATURES:

- Easy to use and a snap to install
- State-of-the-art integrated circuit technology
- 100% automatic - no need for any troublesome adjustments
- Compatible to all types of VCRs and TVs
- The best and most exciting Video Stabilizer in the market
- Light weight (8 ounces) and Compact (1x3.5x5")
- Beautiful deluxe gift box
- Uses a standard 9 Volt battery which will last 1-2 years.

WARNING :

SCO Electronics and RXII dealers do not encourage people to use the Digital Video Stabilizer to duplicate rental movies or copyrighted video tapes. RXII is intended to stabilize and restore crystal clear picture quality for private home use only.

(Dealers Welcome)

To Order: \$49.95 ea + \$4 for FAST UPS SHIPPING
1-800-445-9285 or **516-568-9850**
 Visa, M/C, COD M-F: 9-6 (battery not included)
 SCO ELECTRONICS INC.
 Dept. CRE5 581 W. Merrick Rd. Valley Stream NY 11580
 Unconditional 30 days Money Back Guarantee

CIRCLE 178 ON FREE INFORMATION CARD

CABLE TV DESCRAMBLER

How You Can Save Money
on Cable Rental Fees



1 Unit 5+
 Jerrold SB w/Tri-Bi.....\$99.....\$70
 SuperTri-Bi (TBM).....\$109.....\$75
 Jerrold 450 combo.....\$189.....\$139
 Scientific Atlanta.....\$109.....\$75
 SA 8536.....\$250.....\$195
 Pioneer.....\$109.....\$79
 Oak KN12 (w/VS).....\$109.....\$65
 Hamlin MLD 1200.....\$89.....\$59
 Tocom.....\$169.....\$129
 Stargate converter.....\$89.....\$69
 Panasonic TZPC145.....\$99.....\$79

**US Cable will
Beat Anyone's
Price
Advised in
this Magazine!**

30 Days Money Back Guarantee

Free 16 page Catalog

Visa, M/C, COD or send money order to:

US Cable TV Inc. Dept. KRE5

4100 N. Powerline Rd., Bldg F-4
 Pompano Beach, FL 33073

1-800-445-9285

For Our Record

I, the undersigned, do hereby declare under penalty of perjury that all products purchased, now and in the future, will only be used on Cable TV systems with proper authorization from local officials or cable company officials in accordance with all applicable federal and state laws. FEDERAL AND VARIOUS STATE LAWS PROVIDE FOR SUBSTANTIAL CRIMINAL AND CIVIL PENALTIES FOR UNAUTHORIZED USE.

Date: _____

Signed: _____

No Florida Sales!

CIRCLE 179 ON FREE INFORMATION CARD

AUDIO UPDATE

Japan: The Evolution of an Audio Colossus

LARRY KLEIN

It may seem strange to audio newcomers, but in the early days of hi-fi—the 1950's—there were no Japanese components in the U.S. There was, however, a Japanese domestic audio market. I remember reading about the hi-fi coffee houses with sophisticated sound systems that dotted Tokyo. As further evidence, *Audio* magazine ran intermittent ads from a Tokyo company called Fukuin Electric. Their Pioneer brand products included various drivers plus "An Ideal All-Purpose Amplifier for Home High Fidelity Systems" that was actually an AM/FM shortwave receiver. Neither a price nor a U.S. source was mentioned in any of the ads, so one can assume that Fukuin was trying to attract distributors rather than mail-order customers. True, there was a line of Japanese open-reel tape recorders being sold by a California distributor called Superscope; few knew or cared that they were being made by Sony, another unknown Japanese company. And so things went for several years.

The Japanese invasion

The Japanese entry into the audio market started relatively slowly. In 1966, as Technical Editor of *Stereo Review*, I arranged for the first lab test of a Japanese receiver. Made by Kenwood, it appeared to have nothing terribly innovative about its circuitry, but it was a fine performer and very well made by U.S. standards. We judged it to be an excellent value. Within six months of our report, an upgraded model appeared with four times the power and greatly improved FM performance. The kicker was that it sold for exactly the same price (\$239.95) as the earlier unit! If I had been an American audio manufacturer at the time, I would have become very nervous!

There was another aspect of the Kenwood review worth mentioning. Bear in mind that this all took place

long before the FTC became involved in amplifier specifications, and most audio manufacturers were, let us say, somewhat "optimistic" when reporting their specs. When Mr. Kasuga of Kenwood called to ask how the report was coming, I told him that it was fine and the unit easily met all its specs except for a slight rise in distortion below 50 Hz.

To my surprise, Kasuga became upset and stated that his receiver was free of such problems. I asked our lab to retest the unit; the results were the same. After a great deal of back-and-forthing it turned out that one of our lab meters had developed a fault that caused the spurious large distortion reading. I hadn't originally given the out-of-spec distortion a second thought because virtually all previously tested U.S.-made receivers showed far higher distortion at the same frequencies.

Quality control

A quality-control engineer once said to me that quality is not something you inspect into a product after it's built—it should be designed in

right from the outset. I later learned that this was one of the prime precepts of W. Edwards Deming, who is generally regarded as the father of quality-control methodology. Comparatively unknown in the U.S., in the early 1950's Deming started teaching Japanese managers and engineers how to manufacture quality components. Deming was subsequently awarded a medal and a citation by Emperor Hirohito that credited him for the rebirth and worldwide success of Japan's industry.

The quality concept was one that the Japanese obviously took to heart early on in all aspects of their audio (and camera) manufacturing careers. For example, during my first visit to Japan in the early 1970's, I bought, among other items, a prerecorded cassette from a street display outside a Ginza department store. The cassette was chosen simply because I was amused by its jacket showing what appeared to be a Japanese country-and-western rock group. When I went to play the cassette at home I immediately noticed two things: (1) It was not Dolby encoded,



A QUALITY-CONTROL STATION in Yamaha's Hamatsu Plant.

and (2) it was quieter than most of my prerecorded cassettes that included Dolby noise reduction.

My subsequent experiences with Japanese LP's and prerecorded open-reel tapes were similar. The Japanese tapes were quieter, the records were flatter and had better surfaces, and both had lower distortion and a wider frequency range than the usual U.S. products. And when I first visited Japan, I was so impressed by the clarity, detail, and color of their TV transmissions that I assumed that they were using some system other than the U.S.-standard NTSC. However when some U.S.-made programs were broadcast, it became apparent that the superiority of the Japanese picture was due solely to the care exercised in its production. So, too, with the records and tapes. It was evident that Japanese engineers and production people gave a damn about their products, an attitude that apparently was and is somewhat rare in the U.S. In short, Deming's quality-control methodology provided the tools, the Japanese workers and management provided the attitude—and the rest is history.

Japanese marketing

When Japanese audio products began to appear in the U.S., they were mostly brought in by U.S. distributors, such as Superscope mentioned before. Some American marketers did a creditable job; others didn't seem to realize exactly what they had. For example, I remember a company called Nivico whose product line included several models of German fake fireplaces complete with a bar, glasses, and a "hi-fi" system. This less-than-high-tech company also distributed JVC's top-of-the-line audio equipment. I remember seeing a JVC preamplifier with pink-noise source and multi-band equalizer on sale in Macy's radio department. I have no idea how many were sold—and whether the buyers were told that they would also need a power amplifier, speakers, and a tuner in order to hear music.

In any case, most Japanese manufacturers ultimately bought themselves back from their distributors, some came over on their own, and a few bought U.S. hi-fi companies such as Fisher—via Emerson Radio—and proceeded to design and manufacturer the products in Japan. Some

Cable TV

Descrambler Article Parts

We stock the exact Parts, PC Board and Adaptor for several articles published in Radio-Electronics magazine on building your own Cable TV Descrambler.

February 1984 SB-3 Type	February 1987 Tri-Mode	May 1990 Universal
701 Parts Pkg.....\$19.00 <i>Includes all original parts.</i>	301 Parts Pkg.....29.00 <i>Includes all original parts.</i>	901 Parts Pkg.....\$49.00 <i>Includes all parts.</i>
702 PC Board.....7.95 <i>Original 3X4 etched, drilled and Silk-Screen pc board.</i>	302 PC Board.....7.95 <i>Original 5X8 etched, drilled and Silk-Screen pc board.</i>	902 PC Board.....9.95 <i>Improved 4X7 etched, drilled and Silk-Screened pc board.</i>
704 AC Adaptor.....7.95 <i>12 to 18 Volt DC @ 200ma.</i>	304 AC Adaptor.....7.95 <i>12 to 18 Volt DC @ 200ma.</i>	904 AC Adaptor.....8.95 <i>12 Volts AC @ 350ma.</i>
701, 702 & 704.....29.00 <i>All three for special saving.</i>	301, 302 & 304.....39.00 <i>All three for special savings.</i>	901, 902 & 904.....59.00 <i>All three for special savings.</i>
	Tri-Mode Tutorial..7.95 <i>26 pages of in-depth info.</i>	

Snooper Stopper...\$39.00 <i>Prevent Descrambler detection with snooper stopper/data blocker and protect your privacy. Includes free article on Cable Snooping.</i>	Macrovision Kit...\$29.00 <i>Macrovision.....now you see it, now you don't with our macro-scrubber kit. Originally Published in Radio-Electronics.</i>
---	--

70 Channel Cable TV Converter.....\$89.95

- * 6 Function Infra-Red remote.
- * Fine Tuning.
- * Memory & Recall.
- * Compatible with all External Descrambler.
- * Channel 3 & 4 switchable output.
- * STD, HRC & IRC compatible.

CALL TOLL FREE 1-800-332-3557

Outside USA Call 1-508-699-6935

Visa, MasterCard and COD.
Add \$4.00 S&H, \$6.50 Outside USA.
D & D Electronics, Inc. PO Box 3310, N. Attleboro, Ma. 02761

VISA

MC

CIRCLE 182 ON FREE INFORMATION CARD

No Better Probe Ever at this Price!

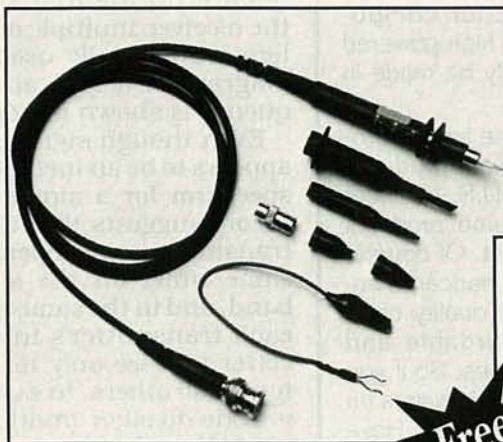

Shown here
Model SP150 Switchable 1x-10x **\$49**

Free

Free probe guide shows economical replacements for Tektronix, H-P, Philips and all others

Risetime less than 1.5 nsec.

- **Universal**
Works with all oscilloscopes
- **Rugged**
Flexible cable lasts longer-
Replaceable ground lead
- **Economical**
Substantial savings compared to
OEM probes
- **10 Day Return Policy**
Guaranteed performance and quality

**TEST
PROBES, INC.**

TPI

9178 Brown Deer Road, San Diego, CA 92121
Toll Free 1-800-368-5719

CIRCLE 123 ON FREE INFORMATION CARD

brands, Sansui for one, in effect came to the U.S. via Vietnam, where they were best sellers in the military PX's. At some point in time, the Japanese began to emulate U.S. auto makers by bringing out new models every year. Their self-imposed rules demanded that each new model include some spec improvement—however minor—and/or a new circuit with wondrous properties. For example, during a visit to the Osaka Technics factory, the engineers showed me a chart on which they had listed their upcoming "breakthrough" improvements for each of the next 5 years!

Audio today

One aspect of the Far-Eastern audio scene that I've not mentioned is their extensive private-labeling enterprises. A friend who owns a U.S. company and manufacturing plant based in Washington state produces a wide range of audio equipment, some of which is built in the Far East. I asked him what determines which is made here and which is made there. His answer was simple: When he expected to sell large numbers of a product—such as his medium-priced receiver—"economies of scale" made it far cheaper to have it manufactured overseas. On the other hand, limited-production components such as his very high-powered amplifiers can profitably be made in his U.S. plant.

That explains why the limited production, "esoteric" audio products are mostly built in the U.S. or Great Britain, while high-volume products are made in the Far East. Of course, there are still a few American manufacturers who put out quality components at both affordable and somewhat high-end prices. So if you are the type of person who insists on buying American, you still can. However, it cannot be denied that the bulk of the electronics industry now belongs to the Far East. I guess all of this has worked out pretty well for the U.S. audio consumer, in that you can get more bang for your audio buck than ever before. But for the American manufacturers, or ex-manufacturers, of audio components (and television sets, cars, and dozens of other categories), the Japanese manufacturing juggernaut has been an economic disaster. **R-E**

2-a-c show how a modulated spread-spectrum signal used in direct sequencing is generated. When a carrier signal (a) is mixed with a noise signal (b), a broadening of the RF carrier occurs, resulting in a modulated spread spectrum (c). Modulation is accomplished using the exclusive OR logic operation. The effect of modulation is to reverse blocks of the wideband noise bits. Because the noise signal is much higher in frequency than the information signal, the resulting bit sequence still appears to be random. The modulated signal is actually the sum of the noise and signal bandwidths.

You're probably wondering how the original information can be decoded at the receiving end. The information signal can be recovered by modulating (exclusive OR) a second time with the same noise waveform. Instead of modulating the information signal with random noise, a PN generator is used, which possesses many properties of wideband noise, but is exactly reproducible at remote locations. In order to remove unintentional noise in the receiver, multiple matched filters are normally used. A block diagram of a typical direct sequence is shown in Fig. 3.

Even though signal spreading appears to be an inefficient use of spectrum for a single user, the theory suggests that many such transmitters can operate at the same time, on the same wide band, and in the same area, since each transmitter's intended receiver will see only its code and ignore all others. In essence, this is code-division multiple access (CDMA).

A spread-spectrum signal looks like low-level noise to a traditional narrowband receiver, and can be designed so that it doesn't interfere with the traditional receiver. In turn, a spread-spectrum receiver can be designed to ignore the interference of even multiple transmitters operating within its broad bandwidth. That resistance to interference can apply to intentional interferers, such as other users

of the spectrum, as well as spurious RF emissions created by many common household and office appliances.

The technique can be viewed as similar to a concert hall with a hundred pianos, each playing a different tune, and each member of the audience listening for one particular tune. As long as the listener can isolate that melody, it doesn't matter how many pianos there are (until the listener is deafened).

Transmit power would generally be at 1 milliwatt, but by using a technique called adaptive power control (APC), each base could monitor and adjust power levels of handsets to the minimum necessary to achieve communication without interference. A reduction in emitted power through APC will permit a far larger number of simultaneous users, so that at one milliwatt, one hundred simultaneous calls can be handled in a microcell within a 600-foot radius.

TDMA

Another technique being considered is time-division multiple access (TDMA). TDMA works by dividing each second into 100 ten-millisecond slots (as an example), and dividing each time slot into a number of frames, typically 24. Half of those frames are then allocated for transmission from base stations to mobile units; and the other half are devoted to transmission in the return direction. Therefore, 12 handsets could broadcast at the same time and place using the same frequency. That technique is used by PCN's in the United Kingdom, and is a technique that has been adopted for the cellular telephone systems in the United States when they become digital over the next few years. The disadvantage of the technique is that it requires extremely precise timing and sophisticated electronics.

The FCC is now considering what action to take. Last June it launched an inquiry into whether PCN's are needed, what they will accomplish, what spectrum should be allotted, if any, and how the new phenomenon should be regulated. Comments poured in from 110 companies,

continued on page 92

DRAWING BOARD

Let's build a simple, inexpensive logic probe for the home workbench.

ROBERT GROSSBLATT

Even though the main reason for spending time at the bench is to wind up with a working circuit, there are other good reasons for spending hours and hours hunched over a breadboard. Nothing ever works out the way you want it to, and that's especially true at the test bench. Dealing with unexpected (or perhaps expected) design glitches is what makes bench time a great way to stretch your brain.

Working your way through a project is a good learning experience, but only if you have the right equipment. For instance, a logic analyzer can instantly give you a window into the nitty gritty of a complex design. But there aren't many of us that can justify parting with the kind of cash that's necessary to get your hands on a logic analyzer—or any other kind of exotic test equipment for that matter. That's especially true when the project has nothing to do with generating income.

While there's no argument that high-tech designs can really be debugged only with high-tech equipment, you can do a lot of work with much simpler and less expensive test gear if you're willing to do a bit more work with your brain. High-speed circuitry can be slowed down, gated latches can be added to catch pulses, and other similar tricks can be pulled to snoop around a circuit.

An extremely useful, but relatively inexpensive addition to any test bench is a logic probe. Now there are all sorts of different logic probes, and just how useful it can be depends on how many bells and whistles it has. A simple two-LED probe is about the bottom line, and the sort of information it can give you is just basic, bottom-line information.

When designing a logic probe, you have to provide a way for the probe to operate with different logic families. That can complicate things slightly because each family—TTL, CMOS, etc.—has its own idea of what volt-

ages constitute a high or low. Not only that, but some of them, such as TTL, also have about a one-volt dead band in which the whole idea of logic levels gets a bit murky.

When you get right down to it, a logic probe is simply a circuit with the ability to detect and react to particular voltage levels. Anytime you're designing something like this and you plan on building it out of parts that are cheap and easily available (as we are), your mind should immediately turn to voltage comparators.

A voltage comparator is really nothing more than an op-amp with a built-in hysteresis that makes it react sharply to voltages that cross a particular threshold. You can build one out of any standard op-amp, but it's a lot easier to use a part like an LM339.

The pinouts for the chip are shown in Fig. 1, and you should be struck by how much they look like op-amps. Just about the only pins that are missing are the ones for frequency compensation and offset adjustments. Those aren't needed in a comparator since the chip is designed to operate more like a switch than an op-amp. The gain is extremely high, the chip can be driven by a sin-

gle-ended supply, and the output can typically sink as much as 16 mA.

The simplest circuit for a logic probe is shown in Fig. 2. As you can see, we've tied together two of the pins; one on each of the comparators. Those are the pins that are going to receive the input voltage from the probe. Since we want the output of both the high and low detectors to go high when they're turned on, we have to make the low detector inverting and set the high detector to be non-inverting. That's why we've connected the non-inverting input of IC1-a, the high detector, to the inverting input of IC1-b, the low detector.

Now that we've decided where we want to put the input signal, the next step in the design is to work out the reference voltages that are going to be applied to the other input pins of the comparators. The easiest way to do that is by building a resistor voltage divider—and that brings us to our first real problem.

If we were going to use the logic probe only with CMOS, the design of the divider would be relatively simple. Since CMOS changes state halfway up the power rail, we could use two equal-value resistors for the divider. But that would seriously affect the versatility of the design so I'm only mentioning it as an aside. We have to do more than that because we also want it to be able to work with the standard TTL levels of below 0.8 volts for a low and above 2 volts for a high.

The way to do that is to use three resistors in the divider chain, as shown in Fig. 2. By separating the high and low reference inputs of the comparators with a resistor, we can have our design account for the TTL deadband voltage range between 0.8 and 2 volts. In Fig. 2, the output of IC1-a will go high if the applied voltage at pin 6 is more than the reference voltage at pin 7, and the output of IC1-b will go high if the applied voltage at pin 5 is lower than the reference voltage at pin 4.

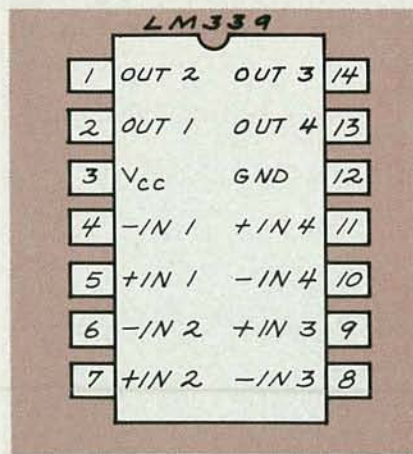

FIG. 1—THE LM339 VOLTAGE-comparator IC contains four comparators on the same substrate. We need only two comparators for a logic probe, so we'll have an extra pair.

FCC LICENSE PREPARATION

The FCC has revised and updated the commercial license exam. The **NEW EXAM** covers updated marine and aviation rules and regulations, transistor and digital circuitry. **THE GENERAL RADIOTELEPHONE OPERATOR LICENSE - STUDY GUIDE** contains vital information. **VIDEO SEMINAR KITS ARE NOW AVAILABLE.**

WPT PUBLICATIONS
 979 Young Street, Suite E
 Woodburn, Oregon 97071
 Phone (503) 981-5159 Dept. 50

CIRCLE 186 ON FREE INFORMATION CARD

MIDI PROJECTS

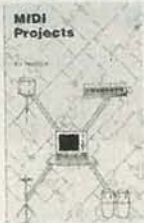

BP182—MIDI interfacing enables any so equipped instruments, regardless of the manufacturer, to be easily connected together and used as a system with easy computer control of these music systems. Combine a computer and some MIDI instruments and you can have what is virtually a programmable orchestra. To get your copy send \$6.95 plus \$1.25 for shipping in the U.S. to **Electronic Technology Today Inc., P.O. Box 240, Massapequa Park, NY 11762-0240.**

LINEAR IC EQUIVALENTS & PIN CONNECTIONS



BP141—Shows equivalents & pin connections of a popular user-oriented selection of European, American and Japanese linear IC's 320 pages, 8 x 10 inches. **\$12.50 Plus \$2.75 shipping.** **ELECTRONIC TECHNOLOGY TODAY INC., PO Box 240, Massapequa Park, New York 11762-0240.**

Now that we've got the basic configuration worked out, the next step is to calculate the values for the resistors. As we go through this, we'll be aiming for the 0.8- and 2-volt thresholds but, since we're going to be using standard-value resistors (things have to be cheap and available, remember?), we'll probably miss the exact numbers by a little bit.

Since we want the reference voltage for IC1-a to be 2 volts (assuming a system voltage of 5 volts), we're aiming for a 3-volt drop across R1—a final ratio of 3/5. That means the value for R1 has to be 60% of the total value of R1 + R2 + R3. Things are a

more complex when we calculate the individual values for R2 and R3 since those two resistors don't see the 5-volt system voltage. The voltage division has to be based on the voltage appearing at pin 7 of IC1-a.

Let's be a bit more rigorous about working this out. The voltage drop across the entire resistive chain is about equal to the system voltage. I'm saying "about" because there is a slight drop due to presence of the comparator, but the impedance of the inputs is so high that we can forget about it for all practical purposes. Since the three resistors are in series, the sum of the voltage drops is

equal to the system voltage.

Since we know that the voltage drop across R1 has to be 3V, the combined voltage drop across the other two resistors will be 2V. We also know that we want the drop across R3 to be 0.8V since that's the value of the reference voltage we're aiming toward. Some simple arithmetic tells us that the R2 drop has to be 1.2V.

Once we've taken the analysis this far, we've also calculated the relative values of the resistors. Since the resistors are in series, the same current is flowing through all of them and that means the resistor values are going to be directly proportional to the voltage drops. R1 is going to be 3/5 of the total, R2 is going to be 1.2/5 of the total, and R3 is going to be 0.8/5 of the total. Putting things in simpler terms, if R_T is the total value of the three resistors, R1 has to be $0.60R_T$, R2 has to be $0.24R_T$, and R3 has to be $0.16R_T$.

Knowing the resistor ratios is only part of the answer since it's still short of knowing the actual values. In theory, any combination of resistors in the correct ratio will work for us but there are some other things we have to take into consideration to come up with the final resistor values.

When we get together next time, we'll take care of that, add a few surprises to the circuit, and get to talking about some other test gear you can build yourself.

R-E

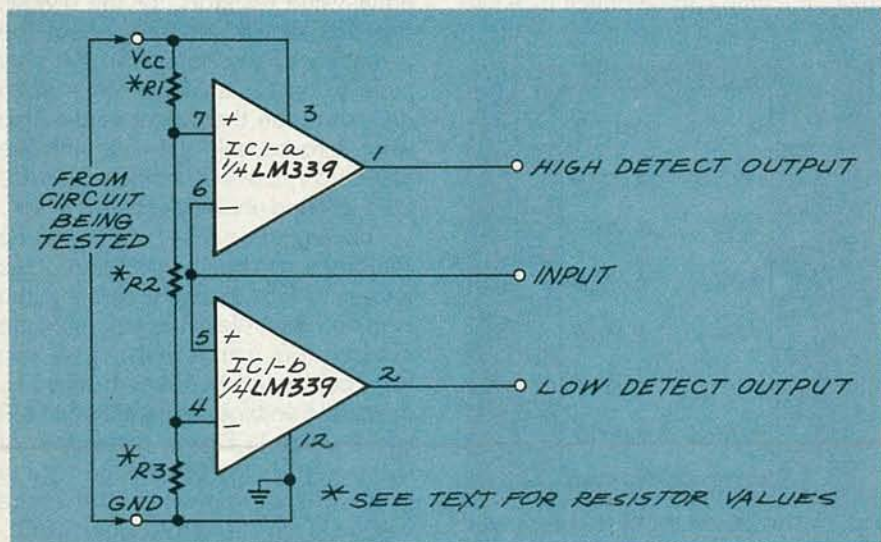

FIG. 2—IN THIS LOGIC-PROBE CIRCUIT we've tied together one pin from each comparator. Those pins will receive the input voltage from the probe. The low detector is inverting and the high detector is non-inverting.

Video standards

JEFF HOLTZMAN

My first video terminal consisted of a 4800-baud MicroTerm terminal, with ASCII keyboard, driving a 5" Sony black-and-white portable TV, through a custom video interface suggested in a book by a guy named Don Lancaster. Resolution was 16 lines by 64 characters; needless to say, bit-mapped graphics were not even a dream.

Today, about 12 years later, I have a 19" NEC MultiSync XL with a non-interlaced graphics resolution of 768 lines \times 1024 rows, in an essentially infinite variety of colors.

What happened in the interim? And what's coming up next?

Memory vs. I/O mapped

Back in the early days of personal computers, user interaction was considered peripheral to the main function, computation. (By contrast, today some heretics believe that computation is peripheral to user interaction.) In line with that type of thinking, user input and output was handled a byte at a time, usually through an RS-232 interface that communicated with the CPU via a single I/O port.

Of course, there were early exceptions from Apple and Commodore. Those companies built memory-mapped displays for the Apple II, the C64, and their successors. However, resolution was so low that sustained professional use produced eye strain. So most business machines centered around Z80's and serial ASCII terminals running under the CP/M operating system.

In August of 1981, IBM introduced its version of the personal computer. The IBM PC was based on a relatively new microprocessor, the 8088, that had 16 times the memory space of the Z80 machines prevalent at the time.

In that seemingly boundless address space, IBM chose to implement a memory-mapped video system, including both a character-

based black-and-white system with resolution sufficient for sustained use in word processors, spreadsheets, and database managers, as well as a bit-mapped color system for entertainment. The two systems were assigned different memory addresses and I/O ports for control, so they could coexist in the same machine simultaneously, a feature useful for programmers who use one screen for program output and the other for debugging. Some CAD systems also put drawings on one screen and menus on another.

In one of the greatest ironies of this industry, and one that we continue to pay for every day, even though the PC was designed with memory-mapped video hardware, IBM's BIOS implemented an interface that mimicked the old ASCII terminal approach. Performance was truly lousy; early PC word processors ran more slowly on a PC than via a 19,200-baud terminal.

Programmers eventually devised more efficient interfaces to the video hardware, but created the problems of portability and compatibility that haunt us to this day, and that will continue to haunt us until the PC architecture has been laid to rest. But that's another story.

Color and pixels

The first bit-mapped graphics system for the PC was called the Color/Graphics array, or CGA for short. In addition to several fuzzy text modes, CGA has two graphics modes: a "high-res" 640 \times 200 in black and white, and a "low-res" 320 \times 200 in four colors. (Table 1 summarizes important video modes and resolutions.) The primary market for CGA adapters was game and educational software.

Business users working in 1-2-3 could display graphs on a CGA monitor, but not on the text-only monochrome display adapter (MDA). IBM missed a marketing opportunity and in stepped Hercules, whose

monochrome graphics adapter quickly became a pseudo-standard whose reign lasted until very recently, when VGA became king of the hill.

The Hercules card brilliantly solved several problems, including support of decent text-mode resolution, a separate graphics mode with resolution exceeding that of the CGA, and the ability to work with standard monochrome monitors, which cost about 20-25% of CGA monitors at the time.

But IBM did not sit still. In 1984, the company introduced the Enhanced Graphics Adapter (EGA), which maintained backward compatibility with the CGA, and added new text and graphics modes. The text mode ran in 16 colors, and had resolution sufficient for day-in and day-out usage. The new graphics modes allowed more colors (16) as well as more resolution (350 lines; columns remained constant at 640 pixels). Although still relatively expensive, the EGA proved that bit-mapped color displays could be useful for things other than arcade games.

(For purposes of this discussion, I'm ignoring several IBM offerings that never took off, including the Professional Graphics Controller (PGC).)

Then, in the spring of 1987, IBM introduced the PS/2 series, which included a new bus (the Micro Channel), a new version of DOS (3.3), 1.44MB floppy disks, and the next video standard, the Video Graphics Array (VGA). DOS 3.3 quickly became standard. It took a little longer, but eventually the new disk format became widespread. The jury is still out on the ultimate acceptance of the Micro Channel architecture. However, in recent years VGA has taken off faster than a stream of electrons inside a CRT. VGA maintains compatibility with CGA and EGA, and adds several more higher-resolution text and graphics modes. In addition, from the beginning VGA included

SELECT 5 BOOKS for only \$4⁹⁵

(values to \$128.70)
and get a **FREE Gift!**

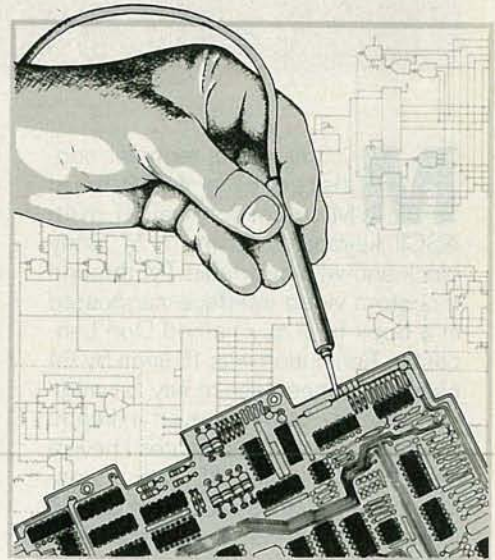

3165 \$17.95



2863P \$17.95



2707P \$17.95



3360 \$29.95
Counts as 2



2613P \$17.95



3307 \$26.95
Counts as 2



2980P \$19.95



2865P \$14.95



3358 \$28.95
Counts as 2



2826P \$16.95



3455 \$25.95
Counts as 2



3321P \$16.95

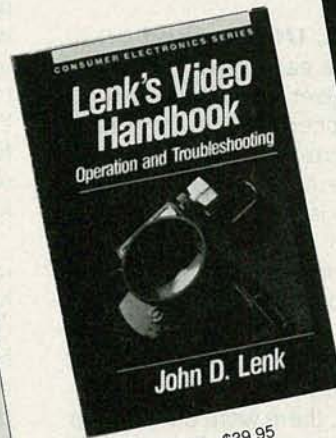

10018 \$39.95
Counts as 2



3205 \$24.95

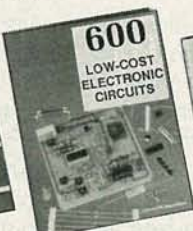

3219 \$27.95
Counts as 2

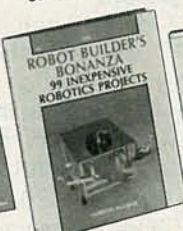

2800P \$16.95



2985 \$24.95



3312 \$23.95



3342 \$25.95
Counts as 2



3285 \$25.95
Counts as 2



3355 \$26.95
Counts as 2

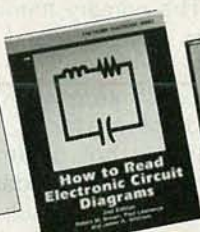

2880P \$14.95



3157P \$16.95



3270 \$32.95
Counts as 2



3458 \$23.95

Your most complete source for electronics books for over 25 years.

An Absolutely No-Risk Guarantee.



FREE when you join!

15 Easy Electronic Projects From Delton T. Horn

Projects you can build—some unique, some old favorites—from the author's vast treasury of electronics know-how.

A \$7.95 Value!

Delton T. Horn's All-Time Favorite Electronic Projects



ELECTRONICS BOOK CLUBSM

Blue Ridge Summit, PA 17294-0810

YES! Please accept my membership in the Electronics Book Club and send the 5 volumes listed below, plus my FREE copy of Delton T. Horn's All-Time Favorite Electronic Projects (3105P), billing me \$4.95. If not satisfied, I may return the books within ten days without obligation and have my membership cancelled. I agree to purchase at least 3 books at regular Club prices during the next 12 months and may resign any time thereafter. A shipping/handling charge and sales tax will be added to all orders.

--	--	--	--	--

Name _____

Address _____

City _____

State _____ Zip _____ Phone _____

Signature _____

Valid for new members only. Foreign applicants will receive special ordering instructions. Canada must remit in U.S. currency. This order subject to acceptance by the Electronics Book Club. RE591

Membership Benefits • Big Savings. In addition to this introductory offer, you keep saving substantially with members' prices of up to 50% off the publishers' prices. • **Bonus Books.** Starting immediately, you will be eligible for our Bonus Book Plan, with savings of up to 80% off publishers' prices. • **Club News Bulletins.** 15 times per year you will receive the Book Club News, describing all the current selections—mains, alternates, extras—plus bonus offers and special sales, with scores of titles to choose from. • **Automatic Order.** If you want the Main Selection, do nothing and it will be sent to you automatically. If you prefer another selection, or no book at all, simply indicate your choice on the reply form provided. You will have at least 10 days to decide. As a member, you agree to purchase at least 3 books within the next 12 months and may resign at any time thereafter. • **Ironclad No-Risk Guarantee.** If not satisfied with your books, return them within 10 days without obligation! • **Exceptional Quality.** All books are quality publishers' editions especially selected by our Editorial Board. (Publishers' Prices Shown)

All books are hardcover unless number is followed by a "P" for paperback. ©1991 ELECTRONICS BOOK CLUB, Blue Ridge Summit, PA 17294-0810

TABLE 1—PC VIDEO MODES

Mode No.*	Mode Type**	Adapter***	Horiz. Res.	Vert. Res.	Max. Colors
0	T/G	CEVS	40	25	16
1	T/G	CEVS	40	25	16
2	T/G	CEVS	80	25	16
3	T/G	CEVS	80	25	16
4	G	CEVS	320	200	4
5	G	CEVS	320	200	4
6	G	CEVS	640	200	2
7	T	CEVSHM	80	25	2
D	G	EVS	320	200	16
E	G	EVS	640	200	16
F	G	EVS	640	350	2
10	G	EVS	640	350	4/16
11	G	VS	640	480	2
12	G	VS	640	480	16
13	G	VS	320	200	256
6A	G	S	800	600	16
100	G	S	640	400	256
101	G	S	640	480	256
102	G	S	800	600	16
103	G	S	800	600	256
104	G	S	1024	768	16
105	G	S	1024	768	256
106	G	S	1280	1024	16
107	G	S	1280	1024	256

* In hexadecimal

** T = Text only, G = Graphics only, T/G = Bit-mapped text

*** C = CGA, E = EGA, V = VGA, S = Super VGA, M = MDA, H = Hercules

built-in gray-scaling capabilities, so you can plug either a monochrome or a color monitor into a given adapter, and your software will run unchanged.

Beyond VGA

VGA is nice, but it's not the end of the story. As soon as IBM introduces a product to the PC market, other vendors quickly seek to improve it, and VGA was no exception. Third-party vendors quickly pushed resolution up to 800×600 , 1024×768 , and other intermediate resolutions. At first, each vendor implemented its hardware and software in different ways. Soon, however, the industry realized it was headed for chaos, so the Video Electronics Standards Association (VESA) formed to define standards for beyond-VGA modes. VESA membership includes virtually all manufacturers of monitors and video adapters—except IBM, Hercules, Compaq, and a few others.

What VESA has done is stan-

dardize horizontal and vertical sweep frequencies, and assign BIOS mode numbers for standard resolutions, as shown in the bottom half of Table 1. These standards should make it easier to write software drivers and assure customers of compatibility.

Beyond Super VGA

Super VGA is *really* nice—but it's not the end of the story either. The reason is that the VGA architecture is dumb, dumb, dumb. It requires the host CPU to do all of its bit twiddling. To draw a line, the host CPU must write directly to memory, often a single memory location for each affected pixel. At low resolution, performance may not be affected much by letting the host CPU do everything. But as resolution increases, the host CPU must spend an increasing proportion of its time tending to the screen, which slows down the rest of the system.

Wouldn't it be nice if the host CPU could delegate some responsibility

and free itself up for other types of tasks? Well, it can. The trick is to put some intelligence on the video adapter card itself. Then the host CPU can tell it, "Draw a line from (X1,Y1) to (X2,Y2), and let me know when you're done," and meanwhile go on and do something else like tend to a background print spooler, recalculate a spreadsheet, reformat or spell-check a document, or accept characters from a modem.

IBM's first entry in the world of intelligent graphics adapters was the 8514/A, introduced shortly after the VGA in 1987. Unfortunately (for IBM), the company shrouded the 8514/A in a veil of secrecy by not publishing hardware-level specs, as the company had for all previous adapters. So third-party vendors had to reverse-engineer on-board IC's, which slowed development of clones and software support, hence acceptance in the market. In addition, the 8514/A is really a half-breed that provides only partially intelligent control over the video buffer. Further, IBM's 8514/A produces an interlaced display that many people (including me) find visually straining. The main justification for interlaced monitors is that they are slower, hence cheaper, than non-interlaced monitors. Although the 8514/A provides comparable resolution and better performance than the better Super VGA boards, it seems unlikely that it will ever attain the importance of VGA.

Beyond beyond-Super-VGA

While IBM floundered, Texas Instruments released the 34010 graphics coprocessor and a robust, general-purpose software interface to it. The 34010 is a full-fledged microprocessor with a powerful instruction set containing many graphics-specific commands. At first, support for the 34010 was sparse, but with the increasing popularity of graphical user interfaces, support is increasing, competition is heating up, and board prices are falling. (See the sidebar for a discussion of Hercules' new 34010 board.)

Of course, IBM doesn't give up without a fight. In the fall of 1990, Big Blue introduced its next-generation video controller, the Extended Graphics Array (XGA). XGA differs from 8514/A in several significant respects. First, it's 100% VGA-compatible. Second, it's more intelligent

R-E Computer Admart

Rates: Ads are 2 1/4" x 2 7/8". One insertion \$995 each. Six insertions \$950 each. Twelve insertions \$925 each. Closing date same as regular rate card. Send order with remittance to Computer Admart, Radio-Electronics Magazine, 500-B Bi-County Blvd., Farmingdale, NY 11735. Direct telephone inquiries to Arline Fishman, area code-1-516-293-3000. FAX 1-516-293-3115. Only 100% Computer ads are accepted for this Admart.

GETTING THE MOST FROM YOUR PRINTER

Getting The Most From Your Printer



BP181—It is probable that 80% of dot-matrix printer users only ever use 20% of the features offered by their printers. This book will help you unlock the special features and capabilities that you probably don't even know exist. To order your copy send \$6.95 plus \$1.50 for shipping in the U.S. to Electronic Technology Today Inc., P.O. Box 240, Massapequa Park, NY 11762-0240.

ICs PROMPT DELIVERY!!!
SAME DAY SHIPPING (USUALLY)
QUANTITY ONE PRICES SHOWN for MAR. 3, 1991

Memory for almost ALL computers

DYNAMIC RAM			
4M Board for hp LJ's w/2MB		\$160.00	
SIMM 4Mx9	80 ns	240.00	
SIMM 1Mx9	60 ns	63.00	
SIMM 1Mx9	80 ns	54.00	
4 Mbit	4Mx1	80 ns	38.00
4 Mbit	1Mx4	80 ns	48.00
1 Mbit	1Mx1	80 ns	5.75
41256	256Kx1	100 ns	2.10
41256	256Kx1	120 ns	1.95
44256	256Kx4	100 ns	5.95
4464	64Kx4	100 ns	1.95
EPROM			
27C4001	512Kx8	150 ns	\$55.00
27C1000	128Kx8	150 ns	16.50
27C512	64Kx8	120 ns	7.50
27256	32Kx8	150 ns	5.00
27128	16Kx8	250 ns	3.40
STATIC RAM			
1 Mbit	128Kx8	100 ns	\$15.00
62256LP	32Kx8	100 ns	6.50

OPEN 6 1/2 DAYS, 7:30 AM-10 PM SHIP VIA FED-EX ON SAT.
SAT DEL ON FED-EX ORDERS RECEIVED BY: 24,000 S. Florida Ave., Ft. Lauderdale, FL 33309 (918) 267-4961
MasterCard/VISA or UPS CASH COD. MICROPROCESSORS UNLIMITED, INC. BEGGS, OK. 74421
No minimum order. Please note: prices subject to change! Shipping, insurance extra, up to \$1 for packing materials.

CIRCLE 61 ON FREE INFORMATION CARD

PT68K4 68000-16MHZ

EGA/VGA

HIGH DENSITY DRIVES

- 4 MB of onboard DRAM
 - 4 RS232 + 2 Parallel Ports
 - Floppy Disk Controller
 - 7 XT Expansion Slots
- 16 MHZ Kits from \$189
Assembled Boards from \$499
Professional OS9/68000 \$299
- Peripheral Technology**
1480 Terrell Mill Rd. Suite 870
Marietta, GA 30067
404/984-0742

CIRCLE 189 ON FREE INFORMATION CARD

than the 8514/A, so it should be faster. Third, it runs only on Micro Channel PS/2's, which limits its potential market. Fourth, it requires a 386 or 486 to run, which also limits its potential market. Fifth, like the 8514/A, the XGA produces an interlaced display, so it's subject to flicker.

At present it's hard to see, given the falling prices of 34010 boards, how the XGA is going to have any significant impact on the market. (For a technical overview of the XGA, see Jake Richter's article in the February issue of *Byte*.)

Color and resolution

In this discussion so far, I've mostly ignored the issue of color. CGA allowed a maximum of four in its low-res mode; EGA increased the maximum to 16; and VGA increased the maximum to 256, but with that many colors the resolution dropped back to the low-res CGA level. (Even so, 256-color images at that resolution are much more realistic than 16-color images at much higher resolutions.) In the meantime, the Super VGA boards developed support for 256 colors at all resolutions up to 1024 x 768.

256 colors are nice—but it really takes about 16 million (2²⁴) colors for true photo-realistic imaging. Special workstations have had that type of imaging for awhile, as have high-end Macintoshes. But now these "true-color" boards are drifting over to the

HERCULES' GRAPHICS STATION CARD

You can sum up the 34010-based Hercules Graphics Station card in three words: speed, speed, speed. I tested it in a 33-MHz 386 under Windows 3.0, and it roughly doubled screen redraw speed. For example, Word for Windows ran about as fast as a text-mode word processor under DOS. The card provides full hardware-level VGA emulation, a 512 x 480 true-color mode, and a 1024 x 768 256-color mode. Sample true-color images included with the board are breathtaking. The board is well-built, and comes with drivers for Windows 3.0, AutoCAD 11, and others.

Installation and documentation are a bit rough, and I encountered the rudest technical-support person I've run across in years while ironing out a driver upgrade problem. But after overcoming those hurdles, I really enjoyed using the Hercules Graphics Station Card. It really puts some zing into Windows, and the company expects to improve performance as Windows learns how to take advantage of intelligent graphics subsystems.

The card lists for about \$1000, but is available through mail-order channels for about \$700. Highly recommended for heavy Windows and AutoCAD users. Hercules Computer Technology, Inc., 921 Parker Street, Berkeley, CA 94710. (415) 540-6000.

CIRCLE 41 ON FREE INFORMATION CARD

PC environment. However, they're very expensive (\$4000 and up).

What's ahead

HDTV continues to loom just beyond the horizon. In terms of the way I spend my time, I don't much care about it for entertainment, but I do care about it in the way it could affect computer-monitor pricing if the technologies converged. The least-expensive 19" 1024 x 768 monitors now go for about \$1500, but if the same technology were used in HDTV displays, that price could easily drop by two thirds. Of course, a strong U.S. presence in HDTV would do much for our economy, the trade deficit, semiconductor manufacturing,.... you name it. Let's hear it for a strong U.S. presence in HDTV!

What to buy

There is no reason not to buy VGA. During the past year the price of a plain VGA adapter card has dropped to about \$100, and monochrome VGA monitors are available for under \$150. Color VGA monitors now go for about \$350, Super VGA monitors for about \$500, and Super VGA board/monitor combinations can also be had for about \$500. Bought as part of a system, color VGA typically adds about \$300 to the overall cost. Don't buy anything less than monochrome VGA, and if you run Windows, aim for 800 x 600 Super VGA as a minimum.

R-E

MAY 1991

MARKET CENTER

FOR SALE

FREE cable and satellite descrambler plans. Send self addressed stamped envelope. **MJM INDUSTRY**, Box 531, Bronx, NY 10461-0208.

TUBES: "oldest," "latest." Parts, and schematics. SASE for lists. **STEINMETZ**, 7519 Maplewood Ave., RE, Hammond, IN 46324.

ENGINEERING software, PC/MSDOS. Hobbyists — students — engineers. Circuit design and drawing, PCB layout, Logic simulation, FFT analysis, Mathematics, Circuit analysis. Call or write for free catalog. 1 (800) 728-3805, **BSOFT SOFTWARE**, 444 Colton Rd., Columbus, OH 43207.

RESTRICTED technical information: Electronic surveillance, schematics, locksmithing, covert sciences, hacking, etc. **Huge selection. Free brochures.** **MENTOR-Z**, Drawer 1549, Asbury Park, NJ 07712.

I'LL HAVE MINE DESCRAMBLED

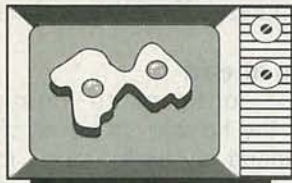

If you find a better deal, We'll beat it! **JERROLD • TOCOM • HAMLIN • OAK • SCIENTIFIC ATLANTA • ZENITH** • ask about our warranty program **C.O.D. Visa, M/C, AM. EX.** welcome. **FREE CATALOG**
• **FREE CALL**
• **OPEN SATURDAYS**

1 800 562-6884

VIDEO TECH
3702 S. Virginia St. Ste. 160-304
Reno, NV 89502

CABLE TV converters: Jerrold, Oak, Scientific Atlantic, Zenith & many others. **"New MTS"** stereo add-on: mute & volume. Ideal for 400 and 450 owners! 1 (800) 826-7623, Amex, Visa, M/C accepted. **B & B INC.**, 4030 Beau-D-Rue Drive, Eagan, MN 55122.

TUBES, new, up to 90% off, SASE, **KIRBY**, 298 West Carmel Drive, Carmel, IN 46032.

FREE CATALOG

FAMOUS "FIRESTIK" BRAND CB ANTENNAS AND ACCESSORIES. QUALITY PRODUCTS FOR THE SERIOUS CB'er. SINCE 1962
FIRESTIK ANTENNA COMPANY
2614 EAST ADAMS
PHOENIX, ARIZONA 85034

TOCOM VIP converters w/remotes from \$299.00. **TOCOM PREMIUM SUPER CHIPS** from \$49.00 turn on everything, guaranteed. Phone (219) 935-4128, evenings 6-12PM EST.

YOU can find anyone! Obtain confidential postal and DMV records, birth/death, credit, etc. \$17.95. **PSSST PRODUCTS**, Box 2501, Huntington Beach, CA 92647.

TOCOM VIP converters w/remotes from \$279.00. Tocom super chips turn on everything, \$49.00 each. Phone (219) 935-4128.

FM 2-way, CB/amateur, scanners, radar detectors, auto alarms, catalog \$2.00, RAYS, PO Box 14862, Fort Worth, TX 76117.

CLASSIFIED AD ORDER FORM

To run your own classified ad, put one word on each of the lines below and send this form along with your check to:

Radio-Electronics Classified Ads, 500-B Bi-County Boulevard, Farmingdale, NY 11735

PLEASE INDICATE in which category of classified advertising you wish your ad to appear. For special headings, there is a surcharge of **\$25.00**.

() Plans/Kits () Business Opportunities () For Sale
() Education/Instruction () Wanted () Satellite Television

Special Category: \$25.00

PLEASE PRINT EACH WORD SEPARATELY, IN BLOCK LETTERS.

(No refunds or credits for typesetting errors can be made unless you clearly print or type your copy.) Rates indicated are for standard style classified ads only. See below for additional charges for special ads. **Minimum: 15 words.**

1	2	3	4	5
6	7	8	9	10
11	12	13	14	15 (\$46.50)
16 (\$49.60)	17 (\$52.70)	18 (\$55.80)	19 (\$58.90)	20 (\$62.00)
21 (\$65.10)	22 (\$68.20)	23 (\$71.30)	24 (\$74.40)	25 (\$77.50)
26 (\$80.60)	27 (\$83.70)	28 (\$86.80)	29 (\$89.90)	30 (\$93.00)
31 (\$96.10)	32 (\$99.20)	33 (\$102.30)	34 (\$105.40)	35 (\$108.50)

We accept MasterCard and Visa for payment of orders. If you wish to use your credit card to pay for your ad fill in the following additional information (Sorry, no telephone orders can be accepted.):

Card Number _____

Expiration Date _____

Please Print Name _____

Signature _____

IF YOU USE A BOX NUMBER YOU MUST INCLUDE YOUR PERMANENT ADDRESS AND PHONE NUMBER FOR OUR FILES. ADS SUBMITTED WITHOUT THIS INFORMATION WILL NOT BE ACCEPTED.

CLASSIFIED COMMERCIAL RATE: (for firms or individuals offering commercial products or services) \$3.10 per word prepaid (no charge for zip code)...**MINIMUM 15 WORDS.** 5% discount for same ad in 6 issues; 10% discount for same ad in 12 issues within one year; if prepaid. **NON-COMMERCIAL RATE:** (for individuals who want to buy or sell a personal item) \$2.50 per word, prepaid...no minimum. **ONLY FIRST WORD AND NAME** set in bold caps at no extra charge. Additional bold face (not available as all caps) 55¢ per word additional. Entire ad in boldface, \$3.70 per word. **TINT SCREEN BEHIND ENTIRE AD: \$3.85 per word. TINT SCREEN BEHIND ENTIRE AD PLUS ALL BOLD FACE AD: \$4.50 per word. EXPANDED TYPE AD: \$4.70 per word prepaid. Entire ad in boldface, \$5.60 per word. TINT SCREEN BEHIND ENTIRE EXPANDED TYPE AD: \$5.90 per word. TINT SCREEN BEHIND ENTIRE EXPANDED TYPE AD PLUS ALL BOLD FACE AD: \$6.80 per word. DISPLAY ADS: 1" x 2 1/4"—\$410.00; 2" x 2 1/4"—\$820.00; 3" x 2 1/4"—\$1230.00. General Information:** Frequency rates and prepayment discounts are available. **ALL COPY SUBJECT TO PUBLISHERS APPROVAL ... ADVERTISEMENTS USING P.O. BOX ADDRESS WILL NOT BE ACCEPTED UNTIL ADVERTISER SUPPLIES PUBLISHER WITH PERMANENT ADDRESS AND PHONE NUMBER.** Copy to be in our hands on the 5th of the third month preceding the date of the issue. (i.e., Aug. issue copy must be received by May 5th). When normal closing date falls on Saturday, Sunday or Holiday, issue closes on preceding working day. Send for the classified brochure. Circle Number 49 on the Free Information Card.

WIRELESS CABLE RECEIVERS 1.9 TO 2.7 GHz



30 CH PARABOLIC DISH SYSTEM \$173.90
 30 CH ROD ANTENNA SYSTEM \$193.90
 30 CH CRYSTAL CONTROLLED SYSTEM \$294.95
 SUN MICROWAVE INT'L. INC. SEND \$1.00 FOR
 P.O. BOX #34522 CATALOG ON THESE
 PHOENIX, AZ 85067 AND OTHER FINE
 (602) 230-0640 VIDEO PRODUCTS
 QUANTITY DISCOUNTS

VISA/MC/AMEX

TEST equipment pre-owned now at affordable prices. Signal generators from \$50.00, oscilloscopes from \$50.00, other equipment, including manuals available. Send \$2.00 U.S. for catalog, refunded on 1st order. **J.B. ELECTRONICS**, 3446 Dempster, Skokie, IL 60076. (708) 982-1973.

CABLE TV converters & descramblers for Jerrold and Scientific Atlanta. Low prices, one year warranty. We ship COD. **BAY STATE ELECTRONICS**, PO Box 103, Boston, MA 02188. 1 (800) 359-9806.

CAR stereos, equalizers, amplifiers, speakers, woofers, tweeters, speaker box supplies, alarms, DJ mixers, more. Large catalog \$1.00. **ELECTRISONIC-K1**, 8400 Alameda, El Paso, TX 79907.

ANTIQUE RADIO CLASSIFIED

Free Sample!
 Antique Radio's



Largest Circulation Monthly.
 Articles, Ads & Classifieds.

6-Month Trial: \$13. 1-Yr: \$24 (\$36-1st Class).
A.R.C., P.O. Box 802-L6, Carlisle, MA 01741

DISCOUNT computer books: Thousands of titles available. Including recent releases. Please call or write for our free catalog. **BOOKWARE**, 344 Water-town Road, Thomaston, CT 06787. 1 (800) 288-5662. (203) 283-6973.

STOP prank phone calls Electronic device displays phone number of person calling you, \$89.95 (assembled), brochure \$1.00, **surveillance** catalog, \$5.00, **EDE**, POB 337, Buffalo, NY 14226.

CABLE descramblers, new X-12 Oak descrambler CH-2-3 \$49.00 10-\$39.00 20-\$29.00, Oak RTC-56 CH-2-3 with remote \$125.00 10-\$115.00 20-\$100.00, M-35-B \$49.00 10-\$39.00 20-\$29.00, Tocom 5503 w/r \$199.00 10-\$189.00 20-\$175.00, SYL 4040 replaces Jerrold 400-DIC w/r \$125.00 10-\$100.00 20-\$75.00, 4040 with internal tri-bi superfast w/r \$165.00 10-\$150.00 20-\$125.00 with internal S-A descrambler \$165.00 10-\$150.00 20-\$125.00, with internal Hamlin descrambler \$125.00 10-\$100.00 20-\$75.00, MLD-1200, SA3B, Super-Tri-Bi, same low prices, Zenith Z-TAC \$225.00 C.O.D. OK **MOUNT HOOD ELECTRONICS** (503) 253-0459.

DESCRAMBLERS, wholesale prices, examples X-12 Oak descrambler \$49.00, RTC-56 combo \$135.00, Tocom 5503 combo \$199.00, 4040 SB combo \$125.00 **S.A.C.**, info (702) 647-3799, orders 1 (800) 622-3799.



Quality Microwave TV Antennas

WIRELESS CABLE - IFTS - MMDS - Amateur TV
 Ultra High Gain 50db(+) • Tuneable 1.9 to 2.7 Ghz.
 • 36-Channel System Complete \$149.95
 • 12-Channel System Complete \$114.95
 • Call or write (SASE) for "FREE" Catalog

PHILLIPS-TECH ELECTRONICS
 P.O. Box 8533 • Scottsdale, AZ 85252
 (602) 947-7700 (\$3.00 Credit all phone orders)
 MasterCard • Visa • COD's • Quantity Pricing

PARTS at bargain prices. Free flyer. **NETWORK SALES**, 90 Turner, Elk Grove, IL 60007. (708) 952-1115.

SECRETS of data encryption standard \$7.00, secure microprocessors explained \$5.00, "smart cards" explained \$5.00. Details free. Sent first class. **BBB**, Box 637, Polk City, FL 33868.

ADULT video tapes 90 min. VHS current color videos assorted titles 1 — \$10.00 3 — \$25.00. Free shipping. **STRINGSOFT**, Box 915-R, Old Bridge, NJ 08857.

CABLE TV converters and descramblers. We sell only the best. Low prices. **SB-3 \$79.00.** We ship C.O.D. Free catalog. **ACE PRODUCTS**, PO Box 582, Dept. E, Saco, ME 04072. 1 (800) 234-0726.

PRINTED circuit boards etched & drilled. Free delivery. **K & F ELECTRONICS, INC.**, 33041 Groesbeck, Fraser, MI 48026. (313) 294-8720.

CABLE descramblers (Jerrold) from \$40.00. Tocom VIP test chip. Fully activates unit. Also Zenith test board. Fully activates Z-Tacs. \$50.00. Call (213) 867-0081.

T.V. notch filters, phone recording equipment, brochure \$1.00. **MICRO THinc.**, Box 63/6025, Margate, FL 33063. (305) 752-9202.

CB RADIO OWNERS!

We specialize in a wide variety of technical information, parts and services for CB radios. 10-Meter and FM conversion kits, repair books, plans, high-performance accessories. Thousands of satisfied customers since 1976! Catalog \$2.

CBC INTERNATIONAL

P.O. Box 31500RE, PHOENIX, AZ 85046

TECHNICIANS. The ultimate test lead, jumper cables with switch \$14.95 each. **MHA**, PO Box 152797, San Diego, CA 92195.

INFRARED remote controlled RF and A/V switches. Write or call to order or get additional information about Infracon's complete MediaMaster series of infrared controlled switches: MediaMaster RF-5X2 and MediaMaster AV-4X4. **INFRACON**, PO Box 1205, Richardson, TX 75085-1205. (214) 437-3366.

PHOTOFACT folders under #1400 \$5.00. Others \$7.00. Postpaid. **LOEB**, 414 Chestnut Lane, East Meadow, NY 11554.

CABLE TV DESCRAMBLERS! BARGAIN HEADQUARTERS!



•JERROLD™ •TOCOM •HAMLIN
 •OAK •ZENITH
 •SCIENTIFIC ATLANTA

6 month warranty! We ship C.O.D.!
 Lowest retail/wholesale prices!

FREE CATALOG:

Global Cable Network
 1032 Irving St. Suite 109
 S.F., CA 94122
 NO CALIFORNIA SALES!!!

ORDER TODAY! 800-327-8544

CABLE TV DESCRAMBLER LIQUIDATION!

FREE CATALOG!

Hamlin Combos \$44, Oak M35B \$60 (min. 5), etc.

WEST COAST ELECTRONICS

For Information: 818-709-1758

Catalogs & Orders: 800-628-9656

THIS IS A BOLDFACE EXPANDED AD. If you like this format the cost is \$5.65 per word.

Try the



bulletin board
 system

(RE-BBS)
 516-293-2283

The more you use it the
 more useful it becomes.

We support 300 and 1200
 baud operation.

Parameters: 8N1 (8 data
 bits, no parity, 1 stop bit)
 or 7E1 (7 data bits, even
 parity, 1 stop bit).

Add yourself to our user
 files to increase your
 access.

Communicate with other
 R-E readers.

Leave your comments on
 R-E with the SYSOP.

RE-BBS
 516-293-2283

CABLE TV

TB-3 (Tri-Bi) or SA-3

Quantity Prices

10 20

\$48.

Each

\$43.

Each

50

100

\$39.

Each

\$35.

Each

Hours open 10:00 am to 4:00 pm Eastern time

Minimum order 5 units 55.00 ea.

Dealers wanted. We ship COD.

King Wholesale

1-800-729-0036

Fax number 6173400053

"No one beats the King's prices!"

DESCRAMBLERS

Cable Descramblers

New Auto Tri-Bi guaranteed no flashing \$165.00

SB-3.....	\$99.00	ZENITH SUPER	
TRIMODE.....	\$109.00	SAAVI.....	\$199.00
HAMLIN.....	\$99.00	TOCOM.....	\$319.00
SCIENTIFIC.....		EAGLE.....	\$119.00
ATLANTA.....	\$119.00	COPY GUARD.....	\$59.95
OAK M35B.....	\$99.00	STARGATE 2000.....	\$88.00
ZENITH.....	\$175.00		

M.D. Electronics will match or beat any advertised wholesale or retail price.

Your best buys and warranties for cable converters and descramblers start with a FREE catalog from MD

For Information Call

402-554-0417

To order or request a free catalog

1-800-624-1150



M.D. ELECTRONICS

875 SO. 72nd St.
Omaha, NE 68114

BY ORDERING CABLE TV EQUIPMENT FROM M.D. ELECTRONICS THE PURCHASER AGREES TO COMPLY WITH ALL STATE AND FEDERAL LAWS REGARDING PRIVATE OWNERSHIP OF CABLE TV EQUIPMENT. IF YOU ARE UNSURE OF THESE LAWS CHECK WITH YOUR LOCAL OFFICIALS.

CIRCLE 53 ON FREE INFORMATION CARD

EXCELLERATOR™ Series CABLE CONVERTERS WHEN QUALITY COUNTS



New Dynatrack™ fine tuning provides unmatched picture quality
550 Mhz tuner provides 83 channel capacity
Sleep timer for automatic shut off within 15-90 minutes
2/3 switchable HRC / IRC / Standard Switchable
2 Year warranty, Last channel recall, Favorite channel select, Scan
Double vented high efficiency transformer for cool performance
Stargate-2001 \$99.00
Stargate-550XL \$119.00 With Volume Control

Don't settle for anything less.



C.O.D.

HYPNOTIZE or Relax electronically! Alpha/meditation goggles. Complete kit \$53.00. Free information. **MARK WORLEY**, Box 261113, San Diego, CA 92196.

SURVEILLANCE transmitter kits! Four models of each; telephone, room, combination telephone/room transmitters tune from 65 to 305 MHz. Catalog with **Popular Communications** and **Popular Electronics** book reviews of "Electronic Eavesdropping Equipment Design," \$2.00. **SHEFFIELD ELECTRONICS**, 7223 Stony Island Ave., Chicago, IL 60649-2806.

POWERFUL single-chip FM voice transmitter, size of a postage stamp, transmits to any FM radio up to one mile away. Complete kit **\$19.95 postpaid**. **HERTZ MICRODEVICES**, Box 41771-B, LA, CA 90041-41771.

SURVEILLANCE electronics, plans, kits, assembled. Catalog \$4.00. **S & S ELECTRONICS**, PO Box 36505-123E, SanJose, CA 95158.

AUDIO! Plans/products — inexpensive, professional, amps, mixers, more! Literature/cassette — \$3.00! **DAVISOUND**, Box 521, Newberry, SC 29108.

CABLE DESCRAMBLERS OAK M35B COMBO \$39.95

Jerrold, Zenith, Hamlin, Sci. Atlanta, Pioneer & MORE! OUR PRICES ARE BELOW WHOLESALE!

CABLE+PLUS

14417 Chase St. #481-A Panorama City, CA 91402
1-800-822-9955 • Other Info. 1-818-785-4500
NO CALIF. SALES — DEALERS WANTED

SATELLITE TV

FREE catalog — Lowest prices worldwide, save 40 — 60%. Systems, upgrades, parts, all major brands factory fresh and warranted. **SKYVISION**, 2009 Collegeway, Fergus Falls, MN 56537. 1 (800) 334-6455.

VIDEOCYpher II descrambling manual. Schematics, video and audio. Explains DES, Eprom, Clonemaster, 3Musketeeer, Pay-per-view (HBO, Cinemax, Showtime, adult, etc.) \$16.95, \$2.00 postage. Schematics for Videocypher Plus, \$20.00. Schematics for Videocypher 032, \$15.00. Collection of software to copy and alter Eprom codes, \$25.00. **CABLETRONICS**, Box 30502R, Bethesda, MD 20824.

RADIO tubes. Scarce new, used. Extensive listings. Capacitors, etc. Illustrated flyer \$1.00 (deductable). **DIERS**, 4276-E7 North 50th Street, Milwaukee, WI 53216-1313.

CABLE TV descramblers wholesale DRX — 3 DIC with remote \$60.00 each for 20 pieces. **CHICAGO CABLE VIDEO**, 923 South Main Street, Algonquin, IL 60102. 1 (800) 442-9653. No Illinois orders.



CODE SCANNER

Compact unit copies Morse, RTTY, ASCII codes from your radio on 32 character LCD display. Ten day money back.

Model CSCAN.....\$189.00+\$5 S&H

MICROGRAFT P.O. Box 513R
Thiensville, WI 53092
Telephone (414) 241-8144

REMOTE CONTROL KEYCHAIN



Complete w/mini-transmitter and 45 vdc RF receiver
Fully assembled including plans to build your own auto alarm
Quantity discounts available

\$24.95 Check, Visa or M/C
Add \$3 shipping

VISITECT INC. BOX 5442, SO. SAN FRAN., CA. 94080
(415) 872-0128 Fax (415) 872-2635

PCB and schematic CAD software. Easy multilayer rubberband zoom pan and more. CGA EGA IBM compatibles. \$195.00. **NUMBER ONE SYSTEMS**, 10565 Bluebird Street, Coon Rapids, MN 55433. Demo Disc. (612) 757-8584.

SURVEILLANCE — Audio/video/infra-red/laser equipment. Industrial or private. 500 item catalog \$7.00. **SECURITY SYSTEMS**, 3017G Hudson, New Orleans, LA 70131.

DIGITAL V.O.M./D.P.M. SALES—SERVICE—PARTS

FLUKE-BECKMAN-SIMPSON-ETC.

U.S. MADE ONLY. QUOTATION PRIOR TO WORK. FAST SERVICE. 90 DAY WARRANTY. STANDARDS TRACEABLE TO NBS. SINCE 1948. CALIBRATION CERTIFICATE AVAILABLE.

INDUSTRIAL INSTRUMENT WKS. INC.
5745 SALMEN, HARAHAN, LA 70123 504/733-8355

CONTROL timing plans: 3 designs for programmable control of relays, power supplies, and more. \$8.95. Free info. **RON DAY**, 1625 Kirkwood Dr., Garland, TX 75041.

ROBOTICS! Engines! Inventions! Muscle wires contract with surprising strength when powered. Send business SASE for latest flyer. **MONDO-TRONICS** c/o RE, 2476 Verna Ct., San Leandro, CA 94577.

PLANS AND KITS

CATALOG: hobby/broadcasting/HAM/CB: Cable TV, transmitters, amplifiers, surveillance devices, computers, more! **PANAXIS**, Box 130-F5, Paradise, CA 95967.

DAZER II personal protection device! Plans \$8.00. Lasers! Transmitters! Detectors! More! Kits or assembled! Catalog \$2.00. **QUANTUM RESEARCH**, 16645-113 Avenue, Edmonton, Alberta T5M 2X2.

DESCRAMBLING, new secret manual. Build your own descramblers for cable and subscription TV. Instructions, schematics for SSAVI, gated sync, sinewave, (HBO, Cinemax, Showtime, UHF, adult) \$12.95, \$2.00 postage. **CABLETRONICS**, Box 30502, Bethesda, MD 20824.

HOW TO use surface mount techniques. Build ultra miniature projects. Included free, two sets plans, infra red remote control, and light display. Send \$15.00 to **CHARLIE'S VIDEO**, Dept. SMT, PO Box 7782, LaSierra, CA 92503.

FREE CATALOG! 1-800-648-7938 JERROLD HAMLIN OAK ETC CABLE TV DESCRAMBLERS

- Special Dealer Prices!
- Compare our Low Retail Prices!
- Guaranteed Prices & Warranties!
- Orders Shipped Immediately!

REPUBLIC CABLE PRODUCTS, INC.

4080 Paradise Rd. #15, Dept RE591
Las Vegas, NV 89109

For all other information (702) 362-9026

VIDEOCYpher II manuals. **Volume 1** — Hardware, **Volume 2** — Software — either \$34.95. **Volume 3** — Projects/Software, **Volume 5** — Documentation or **Volume 6** — Experimentation \$44.95 each. **Volume 4** — Repair \$99.95. **Volume 7** — 032/Hacking \$54.95. **Cable Hacker's Bible** — \$34.95. **Clone Hacker's Bible** — \$34.95. Catalog — \$3.00. **CODES** (602) 782-2316. **TELECODE**, PO Box 6426-RE, Yuma, AZ 85366-6426.

BUY BONDS

BIG PROFITS**ELECTRONIC ASSEMBLY BUSINESS**

Start home, spare time. Investment knowledge or experience unnecessary. **BIG DEMAND** assembling electronic devices. Sales handled by professionals. Unusual business opportunity.

FREE: Complete illustrated literature
BARTA RE-00 Box 248
Walnut Creek, Calif. 94597

BUSINESS OPPORTUNITIES

MAKE \$50/hr working evenings or weekends in your own electronics business. Send for free facts. **MJME INDUSTRY**, Box 531, Bronx, NY 10461-0208.

YOUR own radio station! AM, FM, TV, cable. Licensed/unlicensed. **BROADCASTING**, Box 130-F5, Paradise, CA 95967.

LET the government finance your small business. Grants/loans to \$500,000. Free recorded message: (707) 449-8600. (KS1).

IMPOSSIBLE CABLE SYSTEMS!

- ◆ Zenith PZ ◆ Pioneer Cube ◆ Starcom 6&7 ◆ Standard Units
- ◆ New Generation of **TRIMODES & SB'S**.
- ◆ Quantity prices start at **\$25 each**.

Dealers only Call 1-800-933-2242
Digital Equipment Company of America

MAKE \$75,000 to \$250,000 yearly or more fixing IBM color monitors (and most brands). No investment. Start doing it from your home. (A telephone required.) Information, USA, Canada \$1.00 cash. US funds, other countries \$8.00 **RANDALL DISPLAY**, Box 2168-R, Van Nuys, CA 91404 USA.

EASY work! Excellent pay! Assemble products at home. Call for information (504) 641-8003 Ext. 5192.

MAKE \$\$\$! Become an American electronics dealer! Profit opportunities since 1965. Call **SCOTT PRUETT**, 1 (800) 872-1373.

WANTED

INVENTIONS/ new products/ideas wanted: call **TLCI** for free information 1 (800) 468-7200 24 hours/day - USA/Canada.

INVENTORS: We submit ideas to industry. Find out what we can do for you. **1 (800) 288-IDEA**.

NEED help with your electronic project, PCB assembly/artwork? Write to **T.S.**, PO Box 5275, Flint, MI 48505.

TUBES - 2000 TYPES DISCOUNT PRICES!

Early, hard-to-find, and modern tubes. Also transformers, capacitors and parts for tube equipment. Send \$2.00 for 28 page wholesale catalog.

ANTIQUE ELECTRONIC SUPPLY
6621 S. Maple Ave. • Tempe, AZ 85283 • 602/820-5411

FLUKE SUPER SALE

Model	Price	Model	Price
73 ...	\$ 79	83 ...	\$199
75 ...	\$119	85 ...	\$229
77 ...	\$149	87 ...	\$269
▲ NEW! Model 45 ... \$579 ▼			

KELVIN Electronics
 7 Fairchild Ave., Plainview, NY 11803
 (516) 349-7620 1(800) 645-9212

**DISTINCTIVE RING SWITCH**

Add additional phone numbers to a single line with the new Distinctive Ringing service from the phone company. RingDirector detects ring patterns and routes calls to phones, answering machines, FAX's or modems. 2-port \$89. 4-port \$149. S/H \$5.
1-800-677-7969 FAX 516-676-9225

EXCELLENT TECHNOLOGY
69 Smith Street, Glen Head, NY 11545

INVENTORS! Your first step is important. For free advice, call **ADVANCED PATENT SERVICES**, Washington, DC, 1 (800) 458-0352.

TRAVEL! High income! Radio officers wanted for shipboard employment. Must have FCC second telegraph license. Rae Echols, **AMERICAN RADIO ASSOCIATION**, 5700 Hammonds Ferry, Linthicum, MD 21090.

Be a TV/VCR Repair Specialist

Now you can train at home in spare time for a money-making career as a TV/VCR Repair Specialist. No previous experience necessary. No need to quit your job or school. Everything is explained in easy-to-understand language with plenty of drawings, diagrams and photos. We show you how to troubleshoot and repair video-cassette recorders and TV sets, how to handle house calls and shop repairs for almost any make of television or VCR. Tools are included with your course so you can get "hands-on" practice as you follow your lessons step by step. Send for free facts about the exciting opportunities in TV/VCR Repair and find out how you can start making money in this great career. **MAIL COUPON TODAY** K09C

ICS SCHOOL OF TV/VCR REPAIR, Dept. ADE0415
925 Oak Street, Scranton, PA 18515

Please send me full information and color brochure on how I can learn TV/VCR Repair at home in my spare time. I understand there is no obligation and no salesman will visit me.

Name _____ Age _____
 Address _____ Apt. # _____
 City/State _____ Zip _____
 Phone () _____

MCM Electronics

A Well-Balanced Parts Catalog.

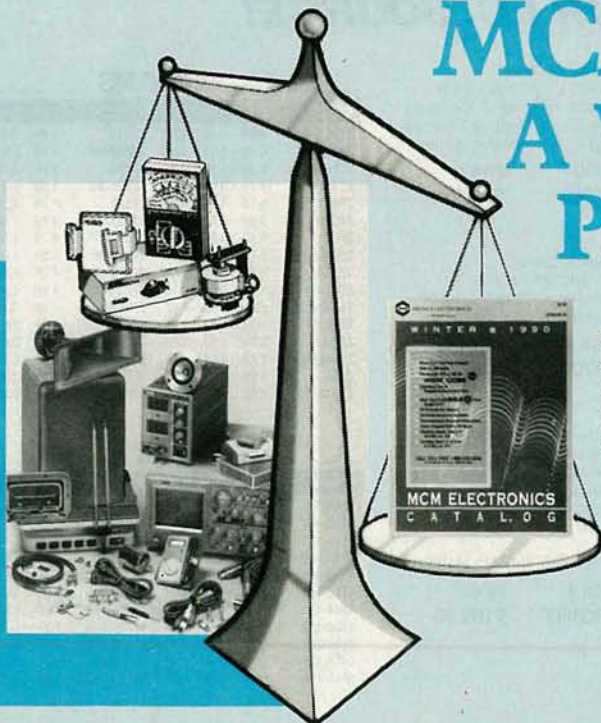

If all you want is a huge assortment of high-quality parts and components, we can tip the scales in our favor in a flash. After all, we stock more than 16,000 items, including loads of name brands (3,000 RCA/GE parts alone!) and the largest selection of Japanese semiconductors in the country!

But as an MCM customer, you'll enjoy even more—like a friendly, well-trained sales staff, technical assistance when you need it and a **GIGANTIC INVENTORY** that lets us ship more than 98% of all orders within 24 hours! So, what are you waiting for?

Call **TOLL-FREE, 1-800-543-4330**,
NOW to get your **FREE**,
ONE-YEAR SUBSCRIPTION to the
MCM Electronics Catalog



MCM ELECTRONICS
650 CONGRESS PARK DR.
CENTERVILLE, OH 45459-4072
A **PREMIER** Company

SOURCE NO. RE-70

MAY 1991

87

PERFECT CABLE CONNECTION !!

Perfect Cable Connection is totally committed to customer satisfaction. Our primary concern is to provide you with the highest quality converters and descramblers at the lowest cost. We employ full time technicians to insure hassle free service and troubleshoot any situation. Call us today and let us prove to you why we are the Perfect Cable Connection.

- 6 months 100% parts & labor
- 24 months warranty available
- Full technical support
- On-line computer system
- 30 days money back guarantee
- Most orders shipped within 24 hours
- Visa, M.C, AMEX - 5%
- Dealers welcome
- C.O.D.

Jerrold 400 DRX 3 DIC WR 1 119 5 89 10 79 20 69 50 65 100 CALL	SA 8536 WR 1 225 5 205 10 185 20 170 50 CALL 100 CALL	Regal RC 83 WR 'New' 1 89 5 69 10 65 50 60 100 55	• 99 Ch capacity • Wireless remote • Automatic line tuning • Parental lock • Made in Japan • Super small • Favorite memory channels	OR M-8 3 1 2 1 39 5 35 10 30 20 27 50 CALL 100 CALL
F.iers 1 CALL 10 CALL 5 CALL 20 CALL 50 CALL 100 CALL	Jerrold 450 DRZ 3 DIC WR 1 129 5 99 10 89 20 79 50 CALL 100 CALL	SA 8500 311 WR 1 199 5 175 10 150 20 CALL 50 CALL 100 CALL	Zenith ZTACS All models Call for prices	CRK 5000 3M WR 1 119 5 99 10 79 20 69 50 CALL 100 CALL
Jerrold 400 DRX 3105 WR 1 55 5 49 10 45 50 40	FB-3 1 75 5 48 10 43 20 39 50 35	SA-3B 1 75 5 48 10 43 20 39 50 35	Jerrold 450 DRZ 3 WR 1 68 5 55 10 45 20 35 50 30	FTB-3 1 99 5 65 10 50 50 CALL 100 CALL

WE WILL MEET OR BEAT ANY ADVERTISED PRICE
IN THIS MAGAZINE.

PERFECT CABLE CONNECTION

702-358-2763
2209 Oddie Blvd., Suite 321
Spark, NV 89431

THIS SPACE CONTRIBUTED AS A PUBLIC SERVICE

A defense against cancer can be cooked up in your kitchen.

There is evidence that diet and cancer are related. Follow these modifications in your daily diet to reduce chances of getting cancer:

1. Eat more high-fiber foods such as fruits and vegetables and whole-grain cereals.
2. Include dark green and deep yellow fruits and vegetables rich in vitamins A and C.
3. Include cabbage, broccoli, brussels sprouts, kohlrabi and cauliflower.
4. Be moderate in consumption of salt-cured, smoked, and nitrite-cured foods.
5. Cut down on total fat intake from animal sources and fats and oils.
6. Avoid obesity.
7. Be moderate in consumption of alcoholic beverages.

No one faces cancer alone.

AMERICAN CANCER SOCIETY

CABLE T.V. CONVERTERS WHY PAY A HIGH MONTHLY FEE?



All Jerrold, Oak, Hamlin, Zenith, Scientific Atlanta, Magnavox and all specialized cable equipment available for shipment within 24 hours. For fast service MC / VISA or C.O.D. telephone orders accepted (800) 648-3030 60 Day Guarantee (Quantity Discounts) 8 A.M. to 5 P.M. C.S.T. **CLOSED WEEK-ENDS.** Send self-addressed Stamped envelope (60¢ postage) for Catalog.

MIDWEST ELECTRONICS INC. P.O. Box 5000
Suite 311 (R)
Carpentersville, IL 60110

No Illinois Orders Accepted.

EDUCATION & INSTRUCTION

F.C.C. Commercial General Radiotelephone license. Electronics home study. Fast, inexpensive! "Free" details. **COMMAND**, D-176, Box 2824, San Francisco, CA 94126.

BUILD a VCR extender in less than an hour! Play TV games in living room, while others watch movies in bedroom. Use existing telephone wires to transmit picture in home; Security, remote control, LAN's, and more. Instructions, complete with theory of operation. \$19.95. **JZO RESEARCH**, Box 28131, Minneapolis, MN 55428.

UNICORN - YOUR I.C. SOURCE!

COLLIMATOR PEN (INFRA-RED)



- Output: 2.5 mW (max.)
- Current: 90-150 mA
- Operating Voltage: 2.2-2.5V
- Wavelength: 820nm
- Collimation: .18mrad (typ.)
- Size: 11mm diameter

STOCK # PRICE
SB1052 \$39.99

LASER DIODE (INFRA-RED)

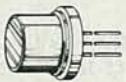

- Output: 10 mW (max.)
- Current: 90-150 mA
- Operating Voltage: 2.2-2.5V
- Wavelength: 820nm

STOCK # PRICE
SB1053 \$9.99

LASER DIODE (VISIBLE-RED)

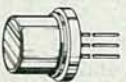

- Output: 5 mW (max.)
- Current: 65-100 mA
- Operating Voltage: 1.75-2.2V
- Wavelength: 780nm

STOCK # PRICE
LS022 \$19.99

LASER DIODE (VISIBLE-RED)

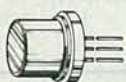

- Output: 4 mW (max.)
- Current: 20 mA
- Operating Voltage: 2.2-3.0V
- Wavelength: 665nm

STOCK # PRICE
LS3200 \$99.99

POWER SUPPLY



- Input: 115/230v
- Size 7" L x 5 1/4" W x 2 1/2" H
- Output: +5 volts @ 3.75 amps
- Output: +12 volts @ 1.5 amps
- Output: -12 volts @ .4 amps

STOCK # PRICE
PS1003 \$19.99

LASER DIODE (VISIBLE-RED)

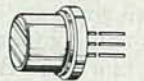

- Output: 3 mW
- Current: 85-100 mA
- Operating Voltage: 2.3-3.0V
- Wavelength: 670nm

STOCK # PRICE
LS9200 \$49.99

LASER POINTER



- Output: 3.5 mW
- Wavelength: 670nm
- Power Supply: 2xAAA Batteries (Included)
- Beam: Approx. 3" @ 100 yards

Quantity Discounts Available
STOCK # PRICE
LSPOINT \$199.99

EPROMS

STOCK #	1-24	25-99	100+	STOCK #	1-24	25-99	100+
1702	4.59	4.36	3.92	2764A	3.49	3.32	2.99
2708	6.49	6.17	5.55	TMS2564	5.79	5.50	4.95
2716	3.29	3.13	2.82	27C64	3.29	3.13	3.28
2716-1	3.79	3.60	3.24	27128-20	4.99	4.74	4.27
TMS2716	5.79	5.50	4.95	27128	4.79	4.55	4.09
27C16	3.99	3.79	3.41	27128A	4.79	4.55	4.09
2732	4.19	3.98	3.58	27C128	4.79	4.55	4.09
2732A-2	3.79	3.60	3.24	27256-20	5.29	5.03	4.53
2732A	3.69	3.51	3.16	27256	4.79	4.55	4.09
2732A-4	3.19	3.03	2.73	27C256	4.29	4.08	3.67
TMS2532	5.79	5.50	4.95	27512-20	6.49	6.17	5.55
TMS2532P	1.99	1.89	1.70	27512	5.99	5.69	5.12
27C32	3.79	3.60	3.24	27C512	5.99	5.69	5.12
2764-20	4.29	4.08	3.67	27C1024	12.99	12.34	11.11
2764	3.99	3.79	3.41	68764	13.99	13.29	11.96
2764A-20	3.99	3.79	3.41	68766	12.99	12.34	11.11

DYNAMIC RAMS

STOCK #	1-24	25-99	100+	STOCK #	1-24	25-99	100+
MK4027	.59	.56	.50	4464-100	2.99	2.84	2.56
4116-120	1.39	1.32	1.19	4464-120	2.79	2.65	2.39
4116-150	.99	.94	.85	4464-150	2.29	2.13	1.96
4116-200	.89	.85	.77	41256-60	2.99	2.84	2.56
4116-250	.59	.56	.50	41256-80	2.79	2.65	2.39
4164-100	1.89	1.80	1.63	41256-100	1.99	1.89	1.70
4164-120	1.69	1.61	1.55	41256-120	1.89	1.80	1.63
4164-150	1.59	1.51	1.36	41256-150	1.79	1.70	1.53
4164-200	1.39	1.32	1.19	511000-70	6.49	6.17	5.55
4416-120	1.99	1.89	1.70	511000-80	5.99	5.69	5.12
4416-150	1.79	1.70	1.53	511000-100	5.49	5.22	4.70

UNICORN ELECTRONICS



ORDER BY PHONE

10010 Canoga Ave., Unit B-8 • Chatsworth, CA 91311
OUTSIDE CALIFORNIA: (800) 824-3432 (Orders Only)
IN CALIFORNIA: (818) 341-8833
ORDER BY FAX: (818) 998-7975

Minimum Order \$15.00 • 24-hour ordering available

ABLE TV EQUIPMENT

Converters, Remote Controls,
Descramblers, CD Players.



WORLD-OAK-SCIENTIFIC ATLANTA-HAMLIN
ZENITH MANY MORE CALL TODAY!

✓ Only quality products sold ✓ Easy to use
Satisfaction guaranteed ✓ Knowledgeable sales staff
✓ Most orders shipped within 24 hours

ALL FOR YOUR FREE CATALOG

1-800-228-7404 VISA

MAKE THE CONNECTION

WITH

NU-TEK ELECTRONICS

5114 Balcones Wood Dr.#307 Dept.298

Austin, TX. 78759

LEARN IBM PC assembly language. 80 programs. Disk \$5.00. Book \$18.00. ZIPFAST, Box 12238, Lexington, KY 40581-2238.

ZENITH & TOCOM SPECIALS

SUPER Zenith (Z-TAC) converters (flashing)... \$179.00. Zenith "turn-on" module... \$49.00. Tocom 5503(A) converters... \$159.00. Tocom (add-on) descramblers... \$79.00. Tocom (5503-VIP & 5507) "turn-on" chips... \$49.00. Tocom 5507 security screw removal bits... \$22.00. CINEPLEX VIDEO GROUP. 1 (800) 726-4627.

AC/DC VOLTAGE PRO 400
AC/DC CURRENT
DIODE TEST Stock No. 990092 \$69.95
LOGIC TEST 990092
LED TEST GOOD/BAD
5 FREQ RANGES
5 CAPACITANCE RANGES
LOW BATTERY Warning
CONTINUITY TEST/BUZZER
TRANSISTOR CHECKER

30 DAY MONEY BACK GUARANTEE!

20 MHZ FREQ COUNTER VISA
KELVIN Electronics M/C
7 Fairchild Ave., Plainview, NY 11803
(516) 349-7620 1(800) 645-9212
FAX (516) 349-7830

INVENTORS

INVENTORS! Can you patent and profit from your idea? Call **AMERICAN INVENTORS CORPORATION** for free information. Over a decade of service 1 (800) 338-5656. In Canada call (413) 568-3753.

MASTERCARD AND VISA are now accepted for payment of your advertising. Simply complete the form on the first page of the Market Center and we will bill.

THE ELECTRONIC GOLDMINE



The Electronic Goldmine has one of the greatest selections of unique electronic kits available in the world! We have over 130 kits and over 1,400 unique, bargain priced, components in our catalog!

FREE CATALOG
with OVER 1400 DIFFERENT ITEMS INCLUDING 135 KITS! REQUEST YOUR COPY TODAY!

AMAZING VALUE

INEXPENSIVE GEIGER COUNTER KIT

Probably the lowest priced Geiger counter kit available in the world today! Features sensitive thin walled Geiger Mueller tube and piezoelectric speaker that emits clicks in proportion to the radiation level. Detects Beta and Gamma rays. Will detect radium dials on old watches, clocks, background radiation, nuclear fallout, etc. Only 3" x 1.88". Operates from one 9V battery (not included). Complete with all parts, PC board and instructions.

C6447 \$39.95



4KV TRIGGER COIL

Use with any strobe tube that needs a 3 lead 4KV trigger.

N1700 \$1.25 EA.
100 for \$80.00

INVERTER TRANSFORMER

Small 4 lead transformer for use with 555 IC to convert 12VDC to 250V for strobe/fluorescent tubes with schematic.

N1703 \$2.00 EA.
1,000 for \$1,500

MINERALIGHT BLACKLIGHT LAMP



Portable short wave mineral light made by VLP. Model LVG-4 features fully portable operation from four AA batteries (not included). This light is rugged and has the famous 5000 hour SW filter to cause fluorescent minerals to glow brightly. G812 \$29.95

G860 \$11.00

PLASTIC ZIPPER CLOSE BAGS

We now offer high quality 2Mil thick zipper close bags with white block to write on. These re-closable bags feature a zipper locking top for convenient storage of small electronic parts, hardware, etc. We have the following sizes:

Sold in multiples of 100 only.
2" X 3" G663 100/\$3.30
3" X 4" G664 100/\$3.75
3" X 5" G665 100/\$4.00
4" X 6" G666 100/\$5.50

RARE EARTH SUPER MAGNET 2

Many times stronger than other magnets, these are the world's strongest commercially available magnets for this size. Small size only about 1" x 5/8" x 1/2" yet can lift 12 to 15 lbs. Try to remove this magnet from a steel plate and you'll find that unless you slide it, you can't get it off. Great for thousands of experiments and applications. Normally these sell for \$60 each, but these are surplus and have a few scratches (does not effect performance). G860 \$11.00

MINIMUM ORDER: \$10.00 plus \$3.00 shipping and handling.

We accept MC, Visa and Money Orders.

SEND ORDERS TO: The Electronic Goldmine

P.O. Box 5406 Scottsdale, AZ 85261

PHONE ORDERS (602) 451-7454 FAX ORDERS (602) 451-9495

CIRCLE 183 ON FREE INFORMATION CARD



2-1/2" SANYO TWEETER

Paper cone with gold tone dust cap. 8 oz. magnet. 8 ohm. 1/2" ferro fluid voice coil. Power handling: 50W RMS, 70W max. Frequency response: 3K-20KHz.



#RD-271-020 \$195 \$175 95c
(1-9) (10-59) (60-up)

SUPER HORN TWEETER

Original piezo tweeter made by Motorola. SPL=94 dB 2.83V/1M. Response: 4KHz-27KHz. Handles approximately 50 watts.



#RD-270-010 \$530 \$450 \$395
(1-9) (10-79) (80-up)

2" DOME MIDRANGE

Textile dome midrange made by Phillips. 8 ohm. SPL=90 dB 1W/1M. 30W RMS, 40W max. Response: 550-5KHz.



#RD-280-210 \$2730 \$2570
(1-3) (4-up)

15" SUBWOOFER



Dual voice coil. 40 oz. magnet. 6 ohm imp. 100W RMS, 140W max. Response: 20-1.2KHz. Resonant frequency: 21Hz. SPL=93 dB 1W/1M.

#RD-290-190 \$5450 \$4980
(1-3) (4-up)

SUBWOOFER XOVER

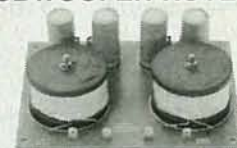

200W RMS crossover designed specifically for use with dual voice coil subwoofers. 12 dB per octave roll-off at 150Hz.

#RD-260-220 \$2880 \$2440

10" POLY WOOFER

Medium duty. 60W RMS, 80W max. 14 oz. magnet. Response: 25-2.5KHz. fs=28Hz.



#RD-290-096 \$1850 \$1690
(1-3) (4-up)

TITANIUM COMPOSITE TWEETER

The advantages of both hard and soft dome technologies. 8 ohm. Ferro fluid cooled voice coil. SPL=90 dB 1W/1M 50W RMS, 70W max. 4" round. Polydax #DTW100T125.

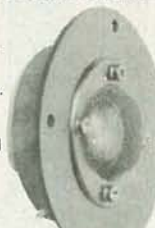

#RD-270-047 \$2750 \$2480
(1-9) (10-up)

SPEAKER BUILDING BOOK

Revised edition of David Weems' best selling book. Learn to build low cost speakers that rival the high priced models.



#RD-500-021 \$1695

12" CAST FRAME WOOFER



12" woofer made in the USA by Eminence. Paper cone and dust cap with treated cloth surround. 80 oz. magnet. 2-1/2" vented voice coil. 8 ohm. 170W RMS, 235W max. 40-4.5KHz response.

#RD-290-147 \$7290 \$6950
(1-3) (4-up)



340 E. First St., Dayton, Ohio 45402
Local: 1-513-222-0173
FAX: 513-222-4644

• 15 day money back guarantee • \$15.00 minimum order • We accept Mastercard, Visa, Discover, and C.O.D. orders. • 24 hour shipping • Shipping charge = UPS chart rate + \$1.00(\$3.00 minimum charge) • Hours 8:30 am - 7:00 pm EST, Monday - Friday • Mail order customers, please call for shipping estimate on orders exceeding 5 lbs. Foreign customers please send \$5.00 U.S. funds for catalog postage.

CALL TOLL FREE
1-800-338-0531



FREE CATALOG

CIRCLE 56 ON FREE INFORMATION CARD

MAY 1991

89

AMAZING SCIENTIFIC & ELECTRONIC PRODUCTS

LASERS AND SCIENTIFIC DEVICES

VRL2K	3mw Vis Red Laser Diode System Kit	\$159.50
LLIS1K	Laser Beam "Bounce" Listener Kit	\$199.50
LHC2K	Visible Simulated 3 Color Laser Kit	\$44.50
LC7	40 Watt Burning Cutting Laser Plans	\$20.00
RUB4	Hi Powered Pulsed Drilling Laser Plans	\$20.00
LGU40	1 to 2mw HeNe Vis Red Laser Gun Assembled	\$199.00
LLS1	Laser Lite Show - 3 Methods Plans	\$20.00
S05K	See in the Dark Kit	\$299.50
EML1K	Electromagnetic Coil Gun Kit	\$69.50
MCP1	Hi Velocity Coil Gun Plans	\$15.00
LEV1	Levitating Device Plans	\$10.00
EH1	Electronic Hypnotism Techniques Plans	\$10.00

HIGH VOLTAGE AND PLASMA DISPLAY DEVICES

HVM7K	75,000 Volt DC Variable Output Lab Source Kit	\$149.50
IOG3K	Ion Ray Gun Kit, project energy without wires	\$69.50
NIG9K	12V/115 VAC Hi Out Neg Ion Generator Kit	\$34.50
EMA1K	Telekinetic Enhancer/Electric Man Assembled	\$99.50
LG5K	Lightning Display Globe Kit	\$54.50
BTC1K	Worlds Smallest Tesla Coil Kit	\$49.50
BTC3K	250KV Table Top Tesla Coil Kit	\$249.50
BTC5	1.5 Million Volts Tesla Coil Plans	\$20.00
JL3	Jacobs Ladder - 3 Models Plans	\$15.00
GRA1	Anti Gravity Generator Plans	\$10.00
PFS20	Plasma Fire Saber Assembled	\$69.50
DPL20	Dancing Plasma to Music and Sounds Assembled	\$79.50

SECURITY AND PROTECTION DEVICES

ITM10	100,000 Volt Intimidator up to 20' Assembled	\$129.50
IPG70	Invisible Pain Field Blast Wave Gen Assembled	\$74.50
PSP4K	Phasor Sonic Blast Wave Pistol Kit	\$59.50
LIS10	Infinity Xmtr, Listen in Via Phone Assembled	\$199.50
TAT30	Automatic Tel Recording Device Assembled	\$24.50
VWPM7K	3 Mi. FM Auto Tel Transmitter Kit	\$49.50
FMV1K	3 Mi. FM Voice Transmitter Kit	\$39.50
HOD1K	Homing/Tracking Beeper Transmitter Kit	\$49.50

EASY ORDERING PROCEDURE TOLL FREE 1-800-221-1705

or 24 HRS ON 1-603-673-4730 or FAX IT TO 1-603-672-5406

VISA, MC, CHECK, MO IN US FUNDS. INCLUDE 10% SHIPPING. ORDERS \$100.00 & UP ONLY ADD \$10.00. CATALOG \$1.00 OR FREE WITH ORDER.

INFORMATION UNLIMITED
P.O. BOX 716, DEPT. R3, AMHERST, NH 03031

CABLE TV DESCRAMBLERS

Qty	1	10	20
Jerrold (Type) SB-3	89.00	56.00	48.00
Jerrold (Type) FTB-3	99.00	69.00	54.00
Scientific Atlanta SA-3	99.00	69.00	54.00
Hamlin MLD-1200	99.00	50.00	45.00
Oak N-12	99.00	59.00	58.00
Tocom 5501	169.00	139.00	125.00
Eagle PD-3	119.00	64.00	60.00

COMBINATION UNITS

Jerrold (Type) DRX-3DIC	169.00	109.00	89.00
Jerrold (Type) Starcom 6	279.00	239.00	209.00
Scientific Atlanta 8535	229.00	209.00	199.00
Scientific Atlanta 8580	299.00	269.00	259.00
Oak M35B	99.00	59.00	49.00

OTHER TYPES ARE OFTEN AVAILABLE

★ We specialize in large quantity discount

★ Call us for pricing on 50 and 100 lot

★ We will not be undersold on large quantities

★ Please have the make and model number of the model you need when calling for information

K.D. VIDEO

P.O. Box 29538, Mpls., MN 55429
TOLL FREE 1-800-327-3407

NEXT MONTH IN Popular Electronics

Exciting Features, Projects, Reports, & Columns

- **A NEW DECADE IN CONSUMER ELECTRONICS**
There's plenty of high-tech excitement in store for the 1990's
- **BUILD THE PROTOMAX PROTOTYPING STATION**
Circuit design is a snap when everything is at your fingertips
- **EXPERIMENTS IN ELECTROCHEMISTRY**
Fascinate yourself and your friends with these fun experiments
- **BUILD THE ACCESS III**
A telephone-operated, remote-control power switch for your computer

Popular Electronics

JUNE 1991



ON SALE APRIL 16, 1991



And there is more!

PRODUCT REVIEWS—Sony Audio/Video Switcher, Nakamichi CD Player/2 CD Changer, Memorex Headphones, and more

DX LISTENING—Tune in to Radio Bangladesh

COMPUTER BITS—What good is Hypertext?

THINK TANK—A primer on current-limiting resistors, a telephone intercom system, a Christmas-tree light tester, and more

HAM RADIO—Some simple fixes for annoying problems

ANTIQUE RADIO—America's love affair with the Theremin

PICK UP Popular Electronics AT YOUR FAVORITE NEWSSTAND, CONVENIENCE STORE, OR SUPERMARKET.

★★★★PRESENTING★★★★
**CABLE TV
 DESCRAMBLERS**
 ★★★★★ STARRING ★★★★★
JERROLD, HAMLIN, OAK
 AND OTHER FAMOUS MANUFACTURERS

- FINEST WARRANTY PROGRAM AVAILABLE
- LOWEST RETAIL / WHOLESALE PRICES IN U.S.
- ORDERS SHIPPED FROM STOCK WITHIN 24 HRS.
- ALL MAJOR CREDIT CARDS ACCEPTED

FOR FREE CATALOG ONLY **1-800-345-8927**
 FOR ALL INFORMATION **1-818-709-9937**

PACIFIC CABLE CO., INC.
 7325 1/2 Reseda Blvd., Dept. 2102
 Reseda, CA 91335

PAY TV AND SATELLITE DESCRAMBLING
 ALL NEW 1991 EDITION

Our best yet. The very latest in descrambling circuits, bypasses, turn-ons for cable, wireless and satellite. Only \$14.95. Other pay TV editions, Vol. 1 (Basics of All Systems) \$14.95. 1989 Edition \$14.95. Build satellite systems under \$600 \$12.95. Wireless Cable Handbook \$9.95. Any 3/\$29.95 or 5/\$44.95. Scrambling News Monthly has all info on the new "Plain Vanilla" descramblers which emulate B-Mac, VCI, Plus and Orion. \$19.95/yr. All new catalog \$1.

Scrambling News, 1552 Hertel Ave.,
 Buffalo, NY, 14216. COD'S ARE OK. (716) 874-2088

THIS SPACE CONTRIBUTED AS A PUBLIC SERVICE

**When someone
 in your family
 gets cancer,
 everyone
 in your family
 needs help.**

Nobody knows better than we do how much help and understanding is needed. That's why our service and rehabilitation programs emphasize the whole family, not just the cancer patient.

Among our regular services we provide information and guidance to patients and families, transport patients to and from treatment, supply home care items and assist patients in their return to everyday life.

Life is what concerns us. So you can see we are even more than the research organization we are so well known to be.

No one faces cancer alone.

AMERICAN CANCER SOCIETY

THIS IS AN EXPANDED TYPE AD. Notice how it stands out on this page. To get your ad set in this type style mark your classified ad order, "Expanded-type ad," and calculate your cost at \$4.70 per word.

THIS IS AN ALL BOLDFACE AD. If you want your entire ad in boldface the cost is \$3.65 per word.

WARNING!

CABLE BOX DEALERS

Consider the facts before you buy after-market cable equipment

An industry standard defines 25% of all after-market cable boxes do not work when first tested...

All wholesalers advertise low prices...but low prices are not enough. Any price is too high if you're without technical support or quality control.

Now consider that your success as a dealer depends on the satisfaction of your customers.

Wholesale Cable Supply offers services that are near a defined science. And we guarantee 100% satisfaction.

Monthly Special

- Guaranteed Low Prices
- State-of-the-Art technical support
- Top Quality Tested Products
- Dealer Market Support

WHOLESALE CABLE SUPPLY

Low Price is only the beginning
1-800-962-6836

723 CAMINO PLAZA, STE. 108, SAN BRUNO, CA 94066

TB-3 or SA-3B	10 lot 48
	20 lot - 43
	50 lot - 39
	100 lot - 39
Z-TAC	10 lot - 149

MARK V ELECTRONICS, INC.

Competitive Pricing * Fast Shipping Since 1985

ORDER IN CALIFORNIA 800-521-MARK
 ORDER OUTSIDE CA 800-423-FIVE
 FREE CATALOG & INFORMATION (213) 888-8988
 FAX (213) 888-6868

▲ indicates the level of difficulty in the assembling of our Products. ▲ Beginner ▲▲ Intermediate ▲▲▲ Advanced ★ Fully Assembled

Special Offer

	TA-3600	TA-477	TA-802	TA-1000A	TA-1500
Amplifier	TA-3600	TA-477	TA-802	TA-1000A	TA-1500
+ Metal Cabinet	LG-1925	LG-1925	LG-1924	LG-1924	LG-1925
+ Transformer	#007	#003	#001	#001	#001
Kit Set	\$155.61	\$125.21	\$100.45	\$113.52	\$130.00
Assmb. Set	\$179.36	\$141.36	\$113.54	\$133.36	\$150.00

• Due to this special offer & low price, we can only exchange or repair any of these units (TA-3600, TA-477, TA-802 & TA-1000A) within 15 days of your receipt.
 • The above prices are for the complete sets. For separate unit price, please see below.

AMPLIFIERS		KIT ASSEMB.		MISCELLANEOUS		KIT ASSEMB.	
MODEL	DESCRIPTION			MODEL	DESCRIPTION		
TA-28MK2	Digital Voice Memo ▲▲		\$ 30.00	TY-23B	3 Channel Color Light Controller ★	\$	\$ 65.00
TA-50A / B	Multi-Purpose Melody Generator ▲		12.84 17.20	TY-25	Stereo Loudspeaker Protector ▲	14.85	20.85
TA-50C	Multi-Purpose Melody (Happy Birthday, Wedding March, etc.) Generator ▲		13.65 18.71	TY-35	FM Wireless Microphone ▲	11.25	
TA-120MK2	35W Class 'A' Main Power Mono Amp. ▲▲		31.50 42.80	TY-36	AC/DC Quartz Digital Clock ▲	19.00	26.20
TA-300	30W Multi-Purpose Single Channel Amp. ▲		20.00 29.00	TY-38	Sound / Touch Control Switch ▲	12.00	
SM-302	60W + 60W Stereo Power Amplifier (with Mic. input) ▲▲		67.00 78.00	TY-41MK V	Infrared Remote Control Unit (w/Case) ▲▲▲	22.00	35.00
TA-323A	30W X 2 Stereo Pre-main Amp. ▲		31.50 42.80	TY-42	Bar / Dot Level Meter ▲▲	24.15	33.81
TA-377A	State of the Art Fully Complementary Symmetrical FET Pre-Amp. ▲▲▲		59.95 75.00	TY-43	3 1/2" Digital Panel Meter ▲	29.00	38.00
TA-400	40W Solid State Mono Amp. ▲		28.00 34.93	TY-45	20 Steps Bar / Dot Audio Level Display ▲▲	38.45	46.14
TA-477	120W Mosfet Power Mono Amp. ▲▲		68.00 85.00	TY-47	Superior Electronic Roulette ▲▲	19.46	27.24
TA-800MK2	120W + 120W Low Tim Pre-Main Stereo Power Amp. ▲▲		63.92	10.000uF	80 V Capacitor (Suggested for TA-3600, TA-477, TA-1000A & TA-802)		23.00
TA-802	80W + 80W Pure DC Stereo Main Power Amp. ▲▲		45.94 59.72	REGULATORS			
TA-1000A	100W Dynamic Class 'A' Main Power Mono Amp. ▲▲		59.69 80.58	TR-355A	0-15V 5A Regulated DC Power Supply (no case & x' former) ▲	\$15.65	\$21.76
TA-1500	100W X 2 Class 'A' DC Stereo Pre-Main Amp. ▲▲▲		73.70 95.81	TR-355B	0-30V 3A Regulated DC Power Supply (no case & x' former) ▲	15.65	21.76
TA-2200	DC Fet Super Class 'A' DC Pre-Amp. ▲▲▲		47.70 58.24	TR-503	0-50V 3A Regulated DC Power Supply (no case & x' former) ▲▲	16.75	23.65
TA-2400A	Electronic Echo & Reverberation Amp. ★		96.00	METAL CABINETS WITH ALUMINUM PANEL			
TA-2500	HQ Pre-Amp w/10 band graphic equalizer ★		68.80	MODEL	H" x W" x D"	MATCHING	PRICE
TA-2800	BI-FET IC Pre-Amp w/3 way tone control ▲▲		48.90 63.57	LG-1273	3" 12" 7"	TA-2800, TA-377A, TA-2200	\$ 22.85
TA-3000	Stereo Simulator (For Mono TV or Any Mono Source) ▲▲		27.00 38.50	LG-1684	4" 16" 8"	TA-323A, TA-377A, TA-2200	27.50
TA-3600	300W HQ Hi-Fi Power Mono Amp. ▲▲▲		85.00 110.00	LG-1924	4" 19" 11 1/2"	TA-802, TA-1500, TA-120MK 2, TA-800 MK2, TA-1000A	32.80
SM-222	7 Band HI-FI Graphic Equalizer ▲▲▲		26.80 38.80	LG-1925	5" 19" 11 1/2"	TA-477, TA-800, MK2, TA-1500, TA-1000A, TA-3600	35.80
SM-328	4 Channel Professional Color Light Controller★		145.00	LG-1983	2 1/2" 19" 8"	TA-377A, TA-2800, TA-2200, TA-120MK 2	29.25
SM-333	Audio/Video Surround Sound Processor ▲▲▲▲		65.00 75.00	POWER TRANSFORMERS			
SM-666	Dynamic Noise Reduction ▲		26.00 34.00	MODEL	DESCRIPTION	MATCHING	PRICE
SM-888	Universal Audio/Video KARAOKE Mixer, Pre-Amp. ★		225.00	001	28V x 2 6A to 30V x 2 6A	TA-800 MK2, TA-802, TA-820A, TA-1000A, TA-1500	\$ 27.00
DIGITAL METERS AND COUNTER				002	36V x 2 3A	TR-503, TA-323A, TA-400, TA-300, TA-377A	22.00
SM-43	3 1/2 Multi-Functional Led D.P.M. (w/ABS plastic case) ▲▲▲		\$ 34.50 \$ 43.00	003	40V x 2 6A	TA-477	28.00
SM-48	4 1/2 Hi-Precision D.P.M. ▲▲▲		38.00 48.00	004	24V x 2 6A	TA-120 MK 2	22.00
SM-48A	4 1/2 Hi-Precision D.P.M. (w/ABS plastic case) ▲▲▲		41.20 52.00	005	28V x 2 3A	TR-355B	16.00
SM-49	3 1/2 Multi-Functional LCD D.M.P. (w/Hold Function) ▲▲		36.00 44.50	006	18V x 2 5A	TR-355A	15.50
SM-100	150MC Digital Frequency Counter ▲▲▲		79.00 90.00	007	53V x 2 8A	TA-3600	43.00
FC-1000A	1 GHz Frequency Counter ★		179.00				

We accept major Credit Cards. Money Orders, Checks and C.O.D. Orders. C.O.D. fee is \$5.00. Minimum order is \$20.00. • We ship by UPS ground inside US (min. \$3.00) and ship by US mail Business & Showroom hours: (Pacific Time) Mon. thru Fri. 9:30 am to 5:00 pm Sat. 10:00 am to 5:00 pm

MARK V ELECTRONICS, INC. - 8019 E. Slauson Ave, Montebello, CA 90640

MAY 1991

- | | |
|--|---|
| <input type="checkbox"/> 221 Popular Electronics (1991 back issues) \$4.00
Write in issues desired _____ | <input type="checkbox"/> 107 Radio-Electronics (1987 back issues) \$5.25
Write in issues desired _____ |
| <input type="checkbox"/> 220 Popular Electronics (1990 back issues) \$4.50
Write in issues desired _____ | <input type="checkbox"/> 106 Radio-Electronics (1986 back issues) \$5.50
Write in issues desired _____ |
| <input type="checkbox"/> 119 Popular Electronics (1989 back issues) \$4.75
Write in issues desired _____ | |
| <input type="checkbox"/> 118 Hands-On Electronics (1988 back issues) \$5.00
Write in issues desired _____ | |
| <input type="checkbox"/> 117 Hands-On Electronics (1987 back issues) \$5.25
Write in issues desired _____ | |
| <input type="checkbox"/> 116 Hands-On Electronics (1986 back issues) \$5.50
Write in issues desired _____ | |
| <input type="checkbox"/> EH91 Experimenters Handbook (1991) \$4.50 | |
| <input type="checkbox"/> EH90 Experimenters Handbook (1990) \$5.00 | |
| <input type="checkbox"/> EH88 Experimenters Handbook (1988-89) \$5.50 | |
| <input type="checkbox"/> EH87 Experimenters Handbook (1987) \$6.00 | |
| <input type="checkbox"/> HH91 Popular Electronics Hobbyist Handbook (1991) \$5.00 | |
| <input type="checkbox"/> HH90 Popular Electronics Hobbyist Handbook (1990) \$5.50 | |
| <input type="checkbox"/> HH89 Popular Electronics Hobbyist Handbook (1989) \$6.00 | |
| <input type="checkbox"/> 126 Radio-Electronics Annual 1986 \$6.00 | |
| <input type="checkbox"/> 211 Radio-Electronics (1991 back issues) \$4.00
Write in issues desired _____ | |
| <input type="checkbox"/> 210 Radio-Electronics (1990 back issues) \$4.50
Write in issues desired _____ | |
| <input type="checkbox"/> 109 Radio-Electronics (1989 back issues) \$4.75
Write in issues desired _____ | |
| <input type="checkbox"/> 108 Radio-Electronics (1988 back issues) \$5.00
Write in issues desired _____ | |

REPRINTS REPRINTS

- | | |
|--|--|
| <input type="checkbox"/> 169 Think Tank (133 Circuits) \$3.50 | <input type="checkbox"/> 169A Think Tank Vol. 2 \$3.00 |
| <input type="checkbox"/> 168 Fact Cards (#34-66) \$4.00 | <input type="checkbox"/> 168C Fact Cards (#67-99) \$3.50 |
| <input type="checkbox"/> 168D Fact Cards (#100-132) \$3.50 | <input type="checkbox"/> 167 Designing With IC's \$4.00 |
| <input type="checkbox"/> 166 Collected Works of Mohammed Ulyses Fips (62 pages, April Fools Collection) \$5.00 | <input type="checkbox"/> 165 How to Repair CD Disc Players \$5.00 |
| <input type="checkbox"/> 165 How to Repair CD Disc Players \$5.00 | <input type="checkbox"/> 164 Modern Electronics (April 1908) \$3.00 |
| <input type="checkbox"/> 164 Modern Electronics (April 1908) \$3.00 | <input type="checkbox"/> 163 Receiving Satellite TV \$5.00 |
| <input type="checkbox"/> 163 Receiving Satellite TV \$5.00 | <input type="checkbox"/> 162 Build Your Own Satellite TV Receiver \$5.00 |
| <input type="checkbox"/> 162 Build Your Own Satellite TV Receiver \$5.00 | <input type="checkbox"/> 161 Descrambling (Feb. 1984) \$3.00 |
| <input type="checkbox"/> 161 Descrambling (Feb. 1984) \$3.00 | <input type="checkbox"/> 160 New Ideas - 42 Circuits \$3.50 |
| <input type="checkbox"/> 160 New Ideas - 42 Circuits \$3.50 | <input type="checkbox"/> 159 Low Frequency Receiving Techniques Building and using VLF Antennas \$5.00 |
| <input type="checkbox"/> 159 Low Frequency Receiving Techniques Building and using VLF Antennas \$5.00 | <input type="checkbox"/> 158 Electro Importing Co. Catalog (Circa 1918) \$5.95 |
| <input type="checkbox"/> 158 Electro Importing Co. Catalog (Circa 1918) \$5.95 | <input type="checkbox"/> 157 All About Kits \$2.00 |
| <input type="checkbox"/> 157 All About Kits \$2.00 | <input type="checkbox"/> 156 How To Make PC Boards \$2.00 |
| <input type="checkbox"/> 156 How To Make PC Boards \$2.00 | <input type="checkbox"/> 155 IBM Typewriter To Computer \$2.00 |
| <input type="checkbox"/> 155 IBM Typewriter To Computer \$2.00 | <input type="checkbox"/> 154 How To Repair VCR's \$3.50 |
| <input type="checkbox"/> 154 How To Repair VCR's \$3.50 | <input type="checkbox"/> 150 Pay TV Decoder (1981) \$3.00 |
| <input type="checkbox"/> 150 Pay TV Decoder (1981) \$3.00 | |

To order any of the items indicated above, check off the ones you want. Complete the order form below, include your payment, check or money order (DO NOT SEND CASH), and mail to **Radio-Electronics**, Reprint Department, P.O. Box 4079, Farmingdale, NY 11735. Please allow 4-6 weeks for delivery.

If you need a copy of an article that is in an issue we indicate is unavailable you can order it directly from us. We charge 50¢ per page. Indicate the issue (month & year), pages and article desired. Include payment in full, plus shipping and handling charge. Make checks payable to Gernsback Publications, Inc.

ARTICLE _____		
PAGES _____	MONTH _____	YEAR _____
TOTAL PAGES _____	@50¢ each	TOTAL PRICE _____

MAIL TO: **Radio-Electronics**
Reprint Bookstore, P.O. Box 4079, Farmingdale NY 11735

SHIPPING CHARGES IN USA & CANADA

\$0.01 to \$5.00.....\$1.25	\$30.01 to 40.00\$5.00	SORRY — We only ship to USA & Canada
\$5.01 to \$10.00.....\$2.00	\$40.01 to 50.00\$6.00	
\$10.01 to 20.00.....\$3.00	\$50.01 and above...\$7.50	
\$20.01 to 30.00.....\$4.00		

All payments must be in U.S. funds

Total price of merchandise\$ _____
 Sales Tax (New York State Residents only)\$ _____
 Shipping Charge (see chart)\$ _____

Name _____ Total Enclosed\$ _____
 Address _____
 City _____ State _____ Zip _____

RE591

for the most part favoring the set-aside of spectrum for PCN's (providing it comes from someone else's allocation). It will take at least three to four years (and that's optimistic) until the dust settles and permanent allocations to PCN's are made. If the tests show that spread spectrum is indeed a feasible way of introducing PCN's without treading on the toes of the current spectrum users, the FCC's problem will be largely solved. Otherwise, it will have to clear spread spectrum by ordering occupants to move to a higher band. After that, the FCC then has to consider the rather large—and perhaps overwhelming—problem of how to license PCN's.

One possibility of licensing PCN's is the cellular paradigm. The FCC divided the country up into over 700 markets, urban and rural, and allotted two licenses to each, one for the telephone company in the area, and one awarded by lottery. While the process led to a lot of people getting extremely rich, especially those involved in preparing applications for licenses, results were less than satisfactory, since two cellular companies have not provided adequate competition (cellular usage prices have not fallen since services were inaugurated in the mid-80's). Another possibility is to have two to four national licensees or, alternatively, licenses could be granted on a regional basis with two or three licensees in each region. If the FCC chooses that approach, there will be a feverish scramble for whatever licenses are offered and there will certainly be several sore losers.

The upshot of all this is that many of America's largest companies will be scurrying frantically in the next few years to ensure that when the dawn arrives, they will have secured their share. The ultimate beneficiary will be the communications user, who will have a new-found freedom to go anywhere without sacrificing the ability to keep in touch with anybody at any time.

R-E

We Have **QUALITY PARTS** • We Have **DISCOUNT PRICES** • We **SHIP FAST**

ALL ELECTRONICS CORP.

24 Vdc MINIATURE GEAR MOTOR

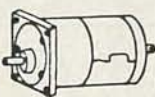

in DC motor # 910 61.112 050 g with no load: 1c @ 5 ma-168 RPM 1c @ 5 ma -84 RPM sion gear motor. jned for 24 Vdc. ates on 12-24 Vdc. 30:1 gear reduction .207 long X 1.18" square mounting brack- s mounting holes on 0.97" centers. Motor ood torque when used at 24 Vdc. **CAT# MOTG-15 \$12.00 each**

I.E.C. POWER CORD

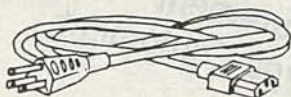

6 foot BLACK, SPH-386 jack to 3 prong molded A.C. plug. Fits most computers, computer terminals and test equipment. **CAT# LCAC-C6 \$3.00 each**

12 Vdc POWER PACK

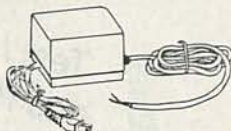

12 Vdc 1 Amp. power pack. 8 ft, 2 conductor power cord on input. 22" cord with stripped and tinned pigtail leads on output. 3.2" X 2.3" X 1.9". **CAT# DCTX-121 \$5.75 each**

FLOURESCENT FIXTURE



Fixture for single mini bi-pin 6", 4 watt fluores- cent lamp. Starter switch, sockets and ballast are mounted on 7 1/4" X 3 1/4" metal plate. Includes 8 foot power cord with strain relief. Use with standard fluorescent lamp for display lighting or with ultraviolet lamp for special ef- fects or EPROM erasure. U.L. listed. **CAT# FLX-1 \$3.00 each**

SWITCHES

Dip P.C. Pushbutton

Schadow Digtast es SE D.T. momentary utton. Mounts in in DIP configuration. igned for low current switching appli- ns. Grey keycap is 0.68" X 0.67". **CAT# PB-28 \$1.00 each** 10 for \$9.50 • 100 for \$85.00



Mercury Tilt Switch

65" long ury tilt switch. S.P.S.T. Closes circuit n switch is tilted approx. 5 degrees. **CAT# MS-3 \$1.00 each** 10 for \$9.50 • 100 for \$85.00

Rotary BCD Switch

10 position ury switch. DIP configuration fits in dard 8 pin I.C. socket. Right angle 3. Screwdriver actuation. 0.42" cube. **CAT# RDIP-2 \$1.75 each** 10 for \$16.00 • 100 for \$145.00

Miniature Toggles

Rated: 3 amps @ 120 Vac !.D.T. (ON-ON) P.C. mount !# MTS-4PC \$1.00 each or \$9.00 - 100 for \$80.00 !.D.T. (ON-ON) solder lugs !# MTS-4 \$1.35 each or \$12.50 - 100 for \$110.00 !.D.T. (ON-ON) solder lugs !# MTS-8 \$1.75 ea. 10 for \$15.00 !.D.T. (ON-ON) P.C. mount !# MTS-8PC \$2.00 ea. 10 for \$17.50

Elephone Keypad

utton telephone pad. Ivory finish. 3" x 2.2" x 0.58" thick. trix encoded. al for telephone or urity keypad. !# KPT-1 \$1.00 each • 10 for \$9.00

Opto-Sensor

W/Optron # OPB5447-2 amitter/sensor pair in ctangular package with color coded leads. !# OSR-4 2 for \$1.00



PHOTOFLASH CAPACITOR

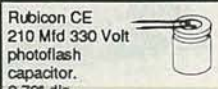

Rubicon CE 210 Mfd 330 Volt photoflash capacitor. 0.79" dia. X 1.1" high. These are new capacitors that have been prepped with 1.4" black and red wire leads soldered to the terminals. **CAT# PPC-210 \$1.25 each • 10 for \$11.00** 100 for \$100.00 Large quantities available. Call for pricing.

RECHARGEABLE BATTERIES

6 Volt 1 Amp/Hour

Japan Storage Battery Co. Portalac # PE6V1 6 Volt 1 Ah rechargeable sealed lead-acid (gell cell). 2" X 1.635" X 2" ht. Batteries are prepped with 5" black and red leads terminated with 2 pin connector. **CAT# GC-61 \$4.75 each** 10 for \$42.50



Nickel-Cad

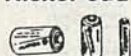

AAA SIZE \$1.50 each 1.2 volts 180 mAh **CAT# NCB-AAA**

AA SIZE \$2.20 each 1.25 volts 500 mAh **CAT# NCB-AA**

AA SIZE \$4.25 each WITH SOLDER TABS **CAT# NCB-SAA**

C SIZE \$4.25 each 1.2 volts 1200 mAh **CAT# NCB-C**

D SIZE \$4.50 each 1.2 volts 1200 mAh **CAT# NCB-D**

HALL EFFECT SENSOR

Microswitch #SS41 Tiny, solid state switch reacts instantly to proximity of magnetic field. Operates at extremely high speeds, up to 100 khz. Case size: 0.12" X 0.17" X 0.06" thick. 4.5 Vdc to 24 Vdc supply voltage. 10 ma. sink type digital output. Operating gauss - 15 to 40. P.C. leads. **CAT# HESW-3 \$1.00 each • 10 for \$9.00** 100 for \$85.00 • 1000 for \$750.00



INSTRUMENT ENCLOSURES

High quality molded ABS instrument enclosures. Integrated PC board standoffs and two sets of vertical mounting slots for front and rear sub panels. All enclosures are 6" wide X 6 1/4" deep. Choice of three hts. Includes non-skid rubber feet and hardware. Available in beige, ivory, black, and blue. **Penal ht. CAT# 2 1/4" CAT# MB-A \$7.50 each 10 for \$65.00** 2 5/8" CAT# MB-B \$7.75 each 10 for \$67.50 3" CAT# MB-C \$8.00 each 10 for \$70.00 Please specify color.



RG-11/U VIDEO CABLE

100 ft. or 200 ft. rolls of RG 11/U 75 ohm cable terminated to heavy duty F connectors. Includes 75 ohm terminator and F-61 splicer on one end. New cables manufactured for IBM PC networks. IBM P/N 1501908 COM/SCOPE. **CAT# RG-11-1 100 ft. roll \$15.00** **CAT# RG-11-2 200 ft. roll \$27.50**



FLASH ASSEMBLY

New compact flash assembly from a U.S. manufacturer of cameras. Operates on 3 Vdc and measures 2 1/2" x 1 1/4". Ideal for use as a strobe, warning light or attention getter. Includes hook-up diagram. **CAT# FSH-1 \$3.75 each** 10 for \$35.00 • 100 for \$325.00



P.C. RELAYS

The following relays all have p.c. pins for both input and output as well as quick-connect terminals on the output. 1.5" X 1.05" X 1.08". UL & CSA listed.



12 Vdc, SPDT Potter & Brumfield # T91R5D22-12-02 12 Vdc, 155 ohm coil, Normally open contacts rated 20 amps. Normally closed contacts rated 10 amps. **CAT# RLY-31 \$2.50 each** 10 for \$22.50

12 Vdc, SPST N. O. Potter & Brumfield # T91R5D22-12-01 12 Vdc, 155 ohm coil, S.P.S.T. normally open con- tacts rated 30 amps. **CAT# RLY-32 \$2.00 each** 10 for \$18.00

L.E.D.'s

Standard JUMBO

Diffused T 1-3/4 size (5 mm)

RED **CAT# LED-1** 10 for \$1.50 • 100 for \$13.00

GREEN **CAT# LED-2** 10 for \$2.00 • 100 for \$17.00

YELLOW **CAT# LED-3** 10 for \$2.00 • 100 for \$17.00

FLASHING LED W/ built in flashing circuit 5 volt operation. T 1-3/4 (5mm)

RED \$1.00 each **CAT# LED-4** 10 for \$9.50

GREEN \$1.00 each **CAT# LED-4G** 10 for \$9.50

YELLOW \$1.00 each **CAT# LED-4Y** 10 for \$9.50

LED HOLDER

Two piece holder. **CAT# HLED** 10 for 65¢

KITS

L.E.D. FLASHER KIT

Two L.E.D.'s flash in unison when a 9 volt battery is attached. This kit includes a p.c. board, all the parts and instructions to make a simple flash- er circuit. A quick and easy project for anyone with basic soldering skills. **CAT# LEDKIT \$1.75 per kit**



L.E.D. CHASER KIT

Build this variable speed led chaser. 10 leds flash sequentially at whatever speed you set them for. Easy to build kit includes pc board, parts and instructions. Ideal for special lighting effects, costumes, etc. Oper- ates on 3 to 9 volts. PC board is 5" X 2.25". A great one hour project. **CAT# AEC \$6.50 each**



STEPPING MOTOR CONTROLLER KIT

Learn about stepping motors while building this simple circuit. Includes circuit board, stepping motor and all parts except 12 Vdc power supply. **CAT# SMKIT \$18.00 each**



METRONOME KIT

This simple device can be set to click from 20 to 1,000 beats per minute. Easy to build, includes circuit board, all components and instructions. Oper- ates on a 9 volt battery (not included). **CAT# METRO \$3.75 each**



PHOTO RESISTOR

1,000 ohms bright light. 16K ohms dark. 0.182" dia. X .08" high. 0.18" long leads. **CAT# PRE-7 2 for \$1.00** 100 for \$45.00 • 1000 for \$400.00



ORDER TOLL FREE 1-800-826-5432

FAX (818) 781-2653 • INFORMATION (818) 904-0524

Call Or Write For Our Free 60 Page Catalog

Outside the U.S.A. send \$2.00 postage for a catalog.

Minimum Order \$10.00 • All Orders Can Be Charged To Visa, Mastercard Or Discovercard • Checks and Money Orders Accepted By Mail • California, Add Sales Tax • Shipping And Handling \$3.50 For the 48 Continental United States - All Others Including Alaska, Hawaii, P.R. And Canada Must Pay Full Shipping • Quantities Limited • No C.O.D. • Prices Subject to change without notice.

DISCOVER

VISA

MasterCard

MAIL ORDERS TO: ALL ELECTRONICS CORP • P.O. BOX 567 • VAN NUYS, CA 91408

CIRCLE 107 ON FREE INFORMATION CARD

MAY 1991

93

Top Performance

Test / Measurement
and Prototype Equipment

GoldStar 20MHz Oscilloscope



Features:

- 6" rectangular CRT display, internal graticule & scale
- Phase difference measurements between two signals using X-Y scope or Dual Trace
- Two different scale probes: x1 and x10
- Bandwidth from DC to 20MHz
- Includes: Two 40MHz probes, two fuses, power cord, operation manual, schematics and block and wiring diagrams
- High sensitivity: 1mV/div
- Two-year manufacturer's warranty

GS7020.....\$499.95

24 Hour
Order Hotline
(415) 592-8097

Global Specialties ProtoBoard® Design Station

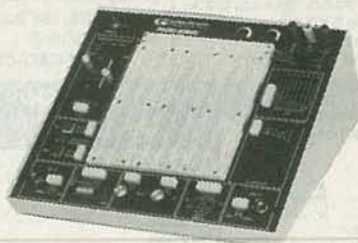

Features:

- Ideal for analog, digital and microprocessor circuits
- Triple DC regulated power supplies, +5V, +15V, -15V
- 8 logic indicators
- Function generator with sine, square, triangle and TTL waveforms
- Two debounced push-button switches
- Two SPDT slide switches, all leads available and uncommitted
- A total of 2520 uncommitted tie-points
- Potentiometers: one 1KΩ and one 10K
- Includes power supply, instrumentation and breadboarding

PB503.....\$299.

Jameco Logic Pulser



- Compatible with TTL, DTL, RTL, HTL, HNIL, MOS and CMOS ICs. • 1MΩ Sync input impedance • Pulser mode output current: 10mA • Square wave current output: 5mA • Audible tone

LP540.....\$16.95

Jameco Logic Probe



- Max Frequency 80MHz • Minimum detectable pulse: 10ns • 120KΩ input impedance • Max. supply voltage: ±25V • TTL threshold: (Lo)+0.8V ±0.1V (Hi) -2.3V ±0.2V • CMOS threshold: (Lo) 30% VCC ±10% (Hi) 70%VCC ±10%

MS104.....\$24.95

A.R.T. EPROM Programmer



- Programs all current EPROMs in the 2716 to 27512 range plus the X2864 EEPROM
- RS232 port • Software included

EPP.....\$199.95

UVP EPROM Eraser



- Erases all EPROM's • Erases 1 chip in 15 minutes and 8 chips in 21 min
- UV intensity: 6800 UW/CM²

DE4.....\$79.95

PROTOTYPING PRODUCTS Jameco Solderless Breadboards

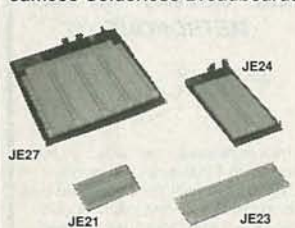

Part No.	Dim. L" x W"	Contact Points	Binding Posts	Price
JE21	3.25 x 2.125	400	0	\$4.95
JE23	6.5 x 2.125	830	0	\$6.95
JE24	6.5 x 3.125	1,360	2	\$12.95
JE25	6.5 x 4.25	1,660	3	\$17.95
JE26	6.875 x 5.75	2,390	4	\$22.95
JE27	7.25 x 7.5	3,220	4	\$32.95

Metex Digital Multimeters

General Specs:

- Handheld, high accuracy • AC/DC voltage, AC/DC current, resistance, diodes, continuity, transistor hFE
- Manual ranging w/ overload protection



- M3650 & M4650 only: • Also measure frequency and capacitance

- M4650 only: • Data hold switch • 4.5 digit

M3610 3.5 Digit Multimeter\$59.95

M3650 3.5 Digit Multimeter w/Frequency & Capacitance\$74.95

M4650 4.5 Digit w/Frequency, Capacitance and Data Hold Switch\$99.95

Handheld Multimeter



- 3.5 digit LCD with automatic polarity indication
- AC/DC voltage measurement up to 500 volts
- AC/DC current measurement up to 200mA
- Resistance measurement up to 20MΩ • Continuity checker with audible tone • Diode and logic tester • Auto/manual range and data hold functions • All range protection and function indications

DMM905.....\$39.95

EPROMs - for your programming needs

Part No.	Price	Part No.	Price	Part No.	Pri
TMS2516	\$4.25	2764-20	\$3.95	27256OTP	\$3.
TMS2532-35	9.95	2764-25	3.75	27256-15	5.
TMS2532A	7.95	2764-45	3.49	27256-20	5.
TMS2564	5.95	2764A-20	3.95	27256-25	4.
TMS2716	5.95	2764A-25	3.25	27C256-15	5.
1702A	3.95	27C64-15	3.95	27C256-20	4.
2708	4.95	27C64-25	3.25	27C256-25	4.
2716	3.49	27128OTP	2.95	27512OTP	4.
2716-1	3.95	27128-20	6.95	27512-20	6.
27C16	4.25	27128-25	4.95	27512-25	5.
2732	4.95	27128A-15	5.95	27C512-15	6.
2732A-20	3.95	27128A-20	4.49	27C512-20	6.
2732A-25	3.49	27128A-25	4.25	27C512-25	5.
2732A-45	2.95	27C128-15	5.95	27C010-15	11.
27C32	3.95	27C128-25	5.75	68766-35	9.

Soldering and Desoldering Stations

60 Watt Analog Display Soldering Station • Electronic temperature control from 200° to 878°F • Cartridge heating element for a longer life of the soldering tip

XY1683.....\$69.95

30 Watt Electronic Temperature Controlled Desoldering Station • Electronic temperature control from 212° to 842°F • Self contained high rotary vacuum pump

XY999.....\$299.95



JAMECO

24 Hour Order Hotline
(415) 592-8097

FAX: (415) 592-2503
(415) 595-2664

• Partial Listing • Over 4000 Electronic and Computer Components in Stock!

CIRCLE 114 ON FREE INFORMATION CARD

Widest Selection

24 Hours A Day!

Computer Products
and Electronic Components

Assemble Your own Computer Kit!

Jameco 16MHz 80386SX Desktop Computer Kit

Building your own computer provides you with a better understanding of components and their functions. In-depth assembly instructions included. Have your new computer assembled and running in an evening, using common tools. Software included. Purchase computer kits configured by Jameco or design your own.

Jameco 16MHz 80386SX Desktop Computer Kit

Includes:
80386SX Motherboard with 1MB RAM (expandable to 8MB)
11-key enhanced keyboard
Multi I/O Card
Shibata 1.44MB, 3.5" DSDD floppy disk drive
Baby sized desktop case
30 Watt power supply
PC DOS 5.0 by Digital Research and Diagsoft's APlus diagnostic software



\$1199.95
JE3816 monitor extra

Hard Drives



Conner (16-bit IDE)

CP3044	40MB 3.5" Low Profile.....	\$469.95
CP3184	80MB 3.5"HH.....	\$649.95
CP3104	100MB 3.5"HH.....	\$699.95
ADP20	Host Adapter.....	\$29.95

Relsys 14" VGA Color Monitor



- Max resolution: 720 x 480
- Bandwidth: 30MHz
- Input: DB15-pin (analog)

RE9513.....\$449.95

Jameco 16-bit VGA Card



- Supports VGA, EGA, CGA, MDA and Hercules modes
- Comes with 256KB video RAM upgradable to 512KB (eight 41464-80)
- Capable of 640 x 480 with 256 colors, 800 x 600 with 16 colors

VG2000.....\$149.95

JAMECO

24 Hour Order Hotline
(415) 592-8097

FAX: (415) 592-2503
(415) 595-2664

1355 Shoreway Road
Belmont, CA 94002

Look to Jameco.....

- Wide selection of integrated circuits and components
- Quality prototype and test equipment
- Computer kits and accessories

Additional items that Jameco offers:

- Tools
- Cables
- Connectors
- Data Books
- Motherboards
- Memory
- Math Coprocessors
- Computer Accessories
- Power Protection Equipment
- Much, much more!

Let us show you what we have to offer; call or write for the latest Jameco catalog!

\$50.00 Minimum Order

Data Sheets - 50¢ each

For a FREE 90-Page catalog send \$2.00 to cover first class Postage and Handling
© 1991 Jameco Electronics 5/91

CA Residents Add

6.00%, 6.50% or 7.00% Sales Tax
Shipping, handling and insurance are additional.
(Costs may vary according to weight and shipping method)
Terms: Prices subject to change without notice.
Items subject to availability and prior sale.

Complete list of terms/warranties is available upon request.
IBM is a registered trademark of International Business Machines



Please refer to Mail Key 2 when ordering

Integrated Circuits

Part No.	1-9	10+	Part No.	1-9	10+
0	\$.29	\$.19	7472	\$.39	\$.29
2	.29	.19	7473	.39	.29
4	.29	.19	7474	.39	.29
5	.35	.25	7475	.49	.39
6	.39	.29	7476	.45	.35
7	.39	.29	7483	.69	.59
8	.35	.25	7486	.45	.35
0	.29	.19	7489	2.95	2.75
1	.35	.25	7490	.49	.39
4	.35	.25	7493	.45	.35
7	.35	.25	74116	1.19	1.09
0	.29	.19	74121	.39	.29
7	.29	.19	74123	.49	.39
0	.29	.19	74125	.49	.39
2	.39	.29	74151	.39	.29
8	.39	.29	74160	.59	.49
2	.49	.39	74161	.69	.59
5	.75	.65	74192	.79	.69
6	.89	.79	74193	.79	.69
7	.89	.79	74194	.79	.69

Dynamic RAMs

4-100	100ns, 64K x 1	\$1.95	41256-100	100ns, 256K x 1	\$2.29
4-120	120ns, 64K x 1	1.89	41256-120	120ns, 256K x 1	2.19
4-150	150ns, 64K x 1	1.75	41256-150	150ns, 256K x 1	1.99
56-60	60ns, 256K x 1	3.25	511000P-80	80ns, 1MB x 1	8.95
56-80	80ns, 256K x 1	2.75	511000P-10	100ns, 1MB x 1	8.49

• Call for a complete listing of IC's

Miscellaneous Components

Potentiometers

Values available (insert ohms into space marked "XX"):
500Ω, 1K, 5K, 10K, 20K, 50K, 100K, 1MEG

43PXX	3/4 Watt, 15 Turn.....	\$.99
63PXX	1/2 Watt, 1 Turn.....	\$.89

Transistors And Diodes

PN2222.....	\$.12	1N4735.....	\$.25	2N4401.....	\$.15
PN2907.....	.12	2N3904.....	.12	1N4148.....	.07
1N4004.....	.10	1N751.....	.15	2N3055.....	.69
2N2222A.....	.25	C106B1.....	.49	1N270.....	.25

Switches

JMT123	SPDT, On-On (Toggle).....	\$1.25
206-8	SPST, 16-pin (DIP).....	\$1.09
MPC121	SPDT, On-Off-On (Toggle).....	\$1.19
MS102	SPST, Momentary (Push-Button).....	\$.39

D-Sub Connectors and Hoods

DB25P	Male, 25-pin.....	\$.65	DB25H	Hood.....	\$.39
DB25S	Female, 25-pin.....	\$.75			

LEDs

XC209R	T1, (Red).....	\$.14	XC556R	T1 3/4, (Red) ...	\$.12
XC556G	T1 3/4, (Green)16	XC556Y	T1 3/4, (Yellow)16

IC Sockets

Low Profile		Wire Wrap (Gold) Level #2	
8LP.....	\$.11	8WW.....	\$.49
14LP.....	.12	14WW.....	.65
16LP.....	.13	16WW.....	.69
24LP.....	.19	24WW.....	1.05
28LP.....	.22	28WW.....	1.29
40LP.....	.28	40WW.....	1.79

Soldertail Standard & Header Plug Sockets Also Available

Customer Service • Technical Assistance • Credit Department • All Other Inquiries • (415) 592-8097 • 7AM - 4PM P.S.T.

CIRCLE 114 ON FREE INFORMATION CARD

MAY 1991

95

SAVE MONEY. DON'T RENT!

CABLE TV DESCRAMBLERS, CONVERTERS, & ACCESSORIES.

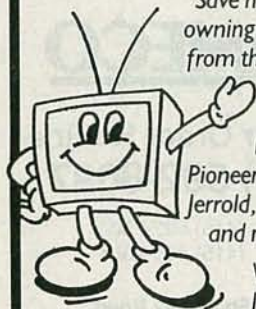

Save hundreds of dollars
owning instead of renting
from the cable company.

Easy to order
and install.

Name brands—
Pioneer, Oak, Panasonic,
Jerrold, Scientific Atlanta
and more.

We're famous for
lowest prices,
excellent service and immediate delivery.
All products fully warranted. Your
satisfaction is 100% guaranteed.

CABLE READY Company

CALL FOR FREE FULLY ILLUSTRATED
16-PAGE COLOR CATALOG.
(800) 234-1006

3 FOR 1 SPECIAL

ON SUB-MINIATURE VOICE
FM TRANSMITTERS.
KITS CONTAIN PC BOARDS



***FMX-1 LONG RANGE (3 MI) ULTRA SENSITIVE
FM VOICE XMTR** with fine tune, range control
plus.....\$34.50



***TELX-1 TELEPHONE FM XMTR (3 MI)** auto-
matically operates when phone is used. Crystal
clear clarity with fine tune and range control.
Non detectable.....\$34.50



***ATR-1 AUTOMATIC TELEPHONE RECORDING
DEVICE** tapes telephone conversation all
automatically.....\$19.50

ALL THREE OF ABOVE FOR.....\$69.50
CALL OR SEND VISA, MASTER CHARGE,
MONEY ORDER, ETC. TO **AMAZING CONCEPTS,**
BOX 716, AMHERST, NH 03031. (603) 673-4730.

ADVERTISING INDEX

RADIO-ELECTRONICS does not assume any responsibility for errors that may appear in the index below.

Free Information Number	Page		
108	AMC Sales	16	178 RE Reprint Bookstore
75	Ace Products	23	181 SCO Electronics
107	All Electronics	93	181 Sencore
—	Amazing Concepts	90,96	— Star Circuits
84	Appliance Service	23	— Tech Spray, Inc.
67	Banner Technical Books	26	92 Tektronix
98	Beckman Industrial	13	123 Test Probes
109	C&S Sales	CV3	— The SPEC-COM Journal
—	CIE	3,31	191 Unicorn
—	Cable Ready Company	96	179 U.S. Cable
180	Cable Warehouse	24	185 Viejo Publications
—	Command Productions	13	186 WPT Publications
58	Cook's Institute	16	— Wholesale Cable
182	D&D Electronics	73	
187	Datak Corporation	24	
127	Deco Industries	23	
183	Electronic Goldmine	89	
—	Electronics Book Club	5,81	
121	Fluke Manufacturing	CV2	
176	General Technics	23	
192	Global Specialties	17	
—	Grantham College	15	
86,193	Heathkit	27,64	
—	Hi-Tech Electronics	23	
114	Jameco	94,95	
104	Jan Crystals	16	
115	Jensen Tools	23	
—	King Wholesale	85	
87	MCM Electronics	87	
53	MD Electronics	86	
93	Mark V. Electronics	91	
190	Matsushita Service Co.	14	
61	Microprocessors Unltd.	83	
117	Mouser	14	
—	NRI Schools	21	
188	Optoelectronics	25	
56	Parts Express	89	
—	Perfect Cable	88	
189	Peripheral Technology	83	
101	Pomona Electronics	7	
78	Radio Shack	32	

ADVERTISING SALES OFFICE

Gernsback Publications, Inc.
500-B Bi-County Blvd.
Farmingdale, NY 11735
1-(516) 293-3000

President: **Larry Steckler**

For Advertising ONLY
516-293-3000
Fax 1-516-293-3115
Larry Steckler

publisher

Christina Estrada

assistant to the President

Arline Fishman

advertising director

Denise Haven

advertising assistant

Kelly McQuade

credit manager

Subscriber Customer Service

1-800-288-0652

Order Entry for New Subscribers

1-800-999-7139

7:00 AM - 6:00 PM M-F MST

SALES OFFICES

EAST/SOUTHEAST

Stanley Levitan, Eastern Sales Manager

Radio-Electronics

259-23 57th Avenue

Little Neck, NY 11362

1-718-428-6037, 1-516-293-3000

Fax 1-718-225-8594

MIDWEST/Texas/Arkansas/Okla.

Ralph Bergen, Midwest Sales Manager

Radio-Electronics

540 Frontage Road—Suite 339

Northfield, IL 60093

1-708-446-1444

Fax 1-708-446-8451

PACIFIC COAST/Mountain States

Marvin Green, Pacific Sales Manager

Radio-Electronics

5430 Van Nuys Blvd. Suite 316

Van Nuys, CA 91401

1-818-986-2001

Fax 1-818-986-2009

RE Shopper

Joe Shere, National Representative

P.O. Box 169

Idyllwild, CA 92349

1-714-659-9734

Fax 1-714-659-2469

48 HOUR SHIPPING

ELENCO & HITACHI PRODUCTS AT DISCOUNT PRICES

48 HOUR SHIPPING

Hitachi RSO Series

(Portable Real-time Digital Storage Oscilloscopes)

VC-6023 - 20MHz, 20MS/s	\$99/mo*
VC-6024 - 50MHz, 20MS/s	\$120/mo*
VC-6025 - 50MHz, 20MS/s	\$135/mo*
VC-6045 - 100MHz, 40MS/s	\$125/mo*
VC-6145 - 100MHz, 100MS/s	\$200/mo*

RSO's from Hitachi feature roll mode, averaging, save memory, smoothing, interpolation, pretriggering, cursor measurements. These scopes enable more accurate, simpler observation of complex waveforms, in addition to such functions as hardcopy via a plotter interface and waveform transfer via the RS-232C interface. Enjoy the comfort of analog and the power to digital.

LEASING AVAILABLE

For all Hitachi Scopes - Call for details

* Based on 24 months except V-1150, VC-6045, VC-6145 (36 months)

Hitachi Portable Scopes

DC to 50MHz, 2-Channel, DC offset function, Alternate magnifier function

V-525 - CRT Readout, Cursor Meas.	\$1,025
V-523 - Delayed Sweep	\$995
V-522 - Basic Model	\$895
V-422 - 40MHz	\$795
V-223 - 20MHz delayed sweep	\$695
V-212 - 20MHz	\$425

HITACHI COMPACT SERIES SCOPES

This series provides many new functions such as CRT Readout, Cursor measurements (V-1085/1065/665), Frequency Ctr (V-1085), Sweeptime Autoranging, Delayed sweep and Tripper Lock using a 6-inch CRT. You don't feel the compactness in terms of performance and operation.

V-660 - 60MHz, Dual Trace	\$1,195
V-665 - 60MHz, DT, w/cursor	\$1,345
V-1060 - 100MHz, Dual Trace	\$1,425
V-1065 - 100MHz, DT, w/cursor	\$105/mo*
V-1085 - 100MHz, QT, w/cursor	\$125/mo*
V-1100A - 100MHz, Quad Trace	\$125/mo*
V-1150 - 150MHz, Quad Trace	\$115/mo*

20MHz Elenco Oscilloscope

\$375

- MO-1251
- Dual Trace Component Tester
 - 6" CRT
 - X-Y Operation
 - TV Sync
 - 2 P-1 Probes



FREE DMM
with purchase of
ANY SCOPE

SCOPE PROBES
P-1 65MHz, 1x, 10x \$19.95
P-2 100MHz, 1x, 10x \$23.95

Elenco 35MHz Dual Trace

Good to 50MHz **\$495**
MO-1252

- High luminance 6" CRT
- 1mV Sensitivity
- 6KV Acceleration Voltage
- 10ns Rise Time
- X-Y Operation • Z Axis
- Delayed Triggering Sweep
- Includes 2 P-1 Probes



All scopes include probes, schematics, operators manual and 3 year (2 yrs for Elenco scopes) world wide warranty on parts & labor. Many accessories available for all Hitachi scopes. Call or write for complete specifications on these and many other fine oscilloscopes.

B + K TEST EQUIPMENT

All Models Available

Call for special price

Digital Capacitance Meter

CM-1550B

\$58.95

- 9 Ranges
- .1pf-20,000ufd
- .5% basic accy.
- Zero control w/ Case
- Big 1" Display



Digital LCR Meter

LC-1801

\$125

- Measures: Coils 1uH-200H
- Caps .1pf-200uf
- Res .01-20M



Multimeter with Capacitance & Transistor Tester

\$55 CM-1500B

- Reads Volts, Ohms
- Current, Capacitors, Transistors and Diodes / with case



Big 1" Display

FLUKE MULTIMETERS

All Models Available

Call for special price

Quad Power Supply XP-580

\$59.95

- 2-20V @ 2A
- 12V @ 1A
- 5V @ 3A
- -5V @ .5A



Fully regulated and short circuit protected

Triple Power Supply XP-620

Assembled **\$65**
Kit **\$45**

- 2 to 15V @ 1A,
- -2 to -15V @ 1A
- (or 4 to 30V @ 1A)
- and 5V @ 3A



All the desired features for doing experiments. Features short circuit protection, all supplies

AM/FM Transistor Radio Kit with Training Course

Model AM/FM 108

\$26.95

- 14 Transistors • 5 Diodes
- Makes a great school project



True RMS 4 1/2 Digit Multimeter M-7000

\$135

- .05% DC Accuracy
- .1% Resistance
- with Freq. Counter and Deluxe Case

GF-8016 Function Generator with Freq. Counter

\$249

- Sine, Square, Triangle Pulse, Ramp, .2 to 2MHz
- Freq Counter .1 - 10MHz



GF-8015 without Freq. Meter \$179

Function Generator Blox

#9600

\$28.95

- Provides sine, triangle, square wave from 1Hz to 1MHz
- AM or FM capability



XK-500 DIGITAL / ANALOG TRAINER

A complete mini-lab for building, testing, prototyping analog and digital circuits. Elenco's Digital / Analog Trainer is specially designed for school projects, with 5 built-in power supplies. Includes a function generator with continuously variable, sine, triangular, square wave forms. All power supplies are regulated and protected against shorts.

POWER SUPPLIES

- Variable Power Supply
- +1.25 to 20VDC @ .5 Amp
- (+1.25 to 15VDC @ 1 Amp)
- -1.25 to -20VDC @ .5 Amp
- (-1.25 to -15VDC @ 1 Amp)
- +12 VDC @ 1 Amp
- -12VDC @ 1 Amp
- +5VDC @ 1 Amp
- 30VAC Center tapped @ 15VAC at 1 Amp

ANALOG - SECTION

- Function Generator Sine, Triangular, Square wave forms
- Frequency adjustable in five ranges from 1 to 100KHz
- Fine frequency adjust
- Amplitude adjust
- DC offset
- Modulation FM-AM

DIGITAL - SECTION

- Eight data switches
- Two no bounce logic switches
- Eight LED readouts TTL, buffered
- Clock frequency 1 to 100KHz
- Clock amplitude 5VPP square wave

BREADBOARDS

- 2 Breadboards, each contain:
- 840 tie points (total 1,680)

\$139.95 Assembled
\$119.95 Kit



Learn to Build and Program Computers with this Kit

Includes: All Parts, Assembly and Lesson Manual

Model

MM-8000

\$129.00



Starting from scratch you build a complete system. Our Micro-Master trainer teaches you to write into RAMs, ROMs and run a 8085 microprocessor, which uses similar machine language as IBM PC.

Robotics Kit for above (MM8010) 71.95

Wide Band Signal Generators

SG-9000 **\$129**

- RF Freq 100K-450MHz AM Modulation of 1KHz Variable RF output
- SG-9500 w/ Digital Display & 150MHz built-in Counter \$249



WE WILL NOT BE UNDERSOLD!

UPS Shipping: 48 States 5%
(\$3 Min \$10 Max) Shipping
IL Res., 7% Tax FAX: 708-520-0085

C & S SALES INC.
1245 Rosewood, Deerfield, IL 60015
(800) 292-7711 (708) 541-0710



15 Day Money Back Guarantee
2 Year Warranty Prices Subject to Change

WRITE FOR FREE CATALOG

Introducing a new companion to your
VA62A Universal Video Analyzing System!

Isolate All Playback Or Record Problems In All VCRs . . . Now And In The Future, Or Your Money Back!

New!



VA62A Universal Video Analyzer

VC93 All Format VCR Analyzer
Patent Pending

**Now you'll have everything to completely analyze all VCR
video, audio, and servo problems.**

Automatic Servo Analyzing: (patent pending)

Automatically determine if the VCR has a capstan servo, cylinder servo, luminance/chrominance circuit defect in virtually the time it takes to connect to the video and audio line outputs.*

Exclusive Video Head Substitution:

Never again install another video head without being 100% positive it will fix the problem. Exclusive video head substitution signals isolate head problems from all other circuit problems.

Exclusive Hi-Fi Stereo And Audio Signals:

Finally there is an answer for troubleshooting VCR Hi-Fi audio circuits. Isolate defects from the spinning heads to the line outputs.

Isolate Defects Throughout The Entire VCR:

Exclusive phase- and chroma-locked drive signals isolate problems in any stage from the heads to the output. Every signal you need is there, including: FM luminance, chroma, video, and head switching (SW30) signals.

Includes Extra Features To Complete Your Servicing Needs:

You get: an Internal NTSC video pattern, standard video and audio line output, a servo sub bias supply to 10 VDC, an autoranged DC and PPV meter, plus it supports all common VCR formats.

*Using the optional Servo Performance Test Leads and Servo Performance Test Tape.

**Call 1-800-SENCORE ext. 544 for more information!
(736-2673)**

CIRCLE 181 ON FREE INFORMATION CARD